

PRICE LIST



THE GLOBAL SPECIALIST
IN ELECTRICAL AND DIGITAL BUILDING INFRASTRUCTURES

MARCH
2019

 **legrand**[®]

LIVE THE ADVANTAGE



Power

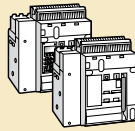

P. 07
DMX³ ACB from
630 A to 6300 A
Fixed version

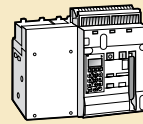

P. 08
DMX³ ACB from
630 A to 6300 A
Draw out version



P. 09
DMX³ ACB,
Protection Units,
Terminal Adapters
& Conversion Kits

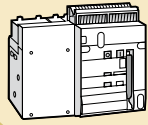

P. 11 NEW!
DMX SP 2500 ACB
630 A to 2500 A
Fixed version
Draw-out version

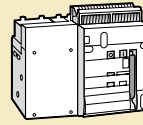

P. 11 NEW!
DMX SP 2500 Switch
disconnectors 630 A to
2500 A Fixed version
Draw-out version



P. 12 NEW!
DMX SP 2500
Protection Units



P. 14
DRX MCCBs

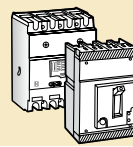

P. 15 to 25
DPX³ MCCBs &
Accessories

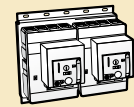

P. 26
DPX³ Automatic
transfer switch,
communication &
super vision system &
panel board display

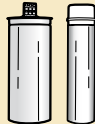

P. 36
ALPX³ resin filled
capacitors standard
and heavy duty
440 V, 480 V & 525 V



P. 36
Alpican gas filled
capacitors
Heavy duty 440 V

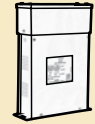

P. 37
Alpx³ box type
capacitors standard
and heavy duty
440 V



**Protection,
Isolation,
Controlling,
Signalling,
Metering.**

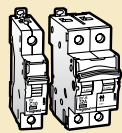

P. 38-44
DX³ MCB
Isolator
RCDs

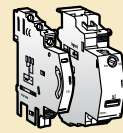

P. 43
DX³
Accessories
and Auxillaries

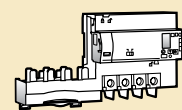

P. 43-45
DX³ RCD
add-on module
with metering



P. 49
Lexic
Time delay
relay

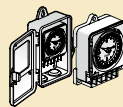

P. 49
Time switches and
Accessories



P. 49
Time lag switches



**Distribution
Boards**



P. 54
Ekinox³
SPN DBs

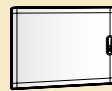

P. 54
Ekinox³
ETPN DBs



P. 54
Ekinox³
Flexy DBs



P. 56
Ekinox³
7 Segment
MCCB DBs



P. 56
Ekinox³ Metra
Plug & Socket
DBs



P. 56
Ekinox³
P17 Tempra Plug
& Socket DBs



**Arteor™
Wiring
Accessories**

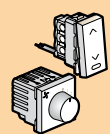

P. 76
Switches, Push buttons,
Dimmers & Regulators
square white &
Magnesium mechanism



P. 77
Indian standard
sockets, USB Chargers,
Data & voice, Hotel
funtions, Audio Video

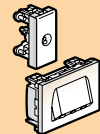

P. 78
USB Charger, RJ11
Telephone Sockets,
Information outlets

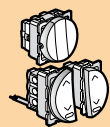

P. 80
Switches, Push
buttons, Dimmers &
Regulators, Round
White Mechanism

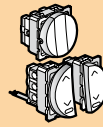

P. 81
Switches,
Push buttons



P. 81
Dimmers &
Regulators
Round Magnesium
Mechanism



**Myrius™
Wiring
Accessories**



P. 92-93
Switches,
Push buttons, Sockets,
Power units and
Dimmer and regulators
White mechanisms

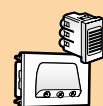

P. 93
ELU / Indicators,
Skirting light, Indicators,
Buzzors, Sensors and
Remote unit



P. 93-94
Hospitality
functions, Sockets
& connectors,
Data & voice

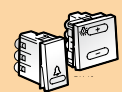

P. 95
Dimmer &
regulators
Black mechanisms

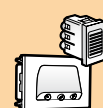

P. 96
ELU / Indicators,
Skirting light,
Indicators, Buzzors
& Sensor



P. 96
Remote unit,
Hospitality functions,
Sockets & connectors,
Data & voice

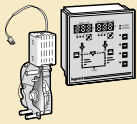

P. 10
Auxilliaries &
Accessories

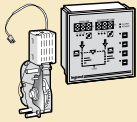

P. 12 **NEW!**
Auxilliaries &
Accessories



P. 27
CTX³
contactors

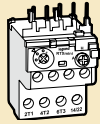

P. 29
RTX³
thermal relays

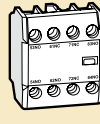

P. 30
CTX³
accessories

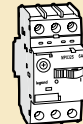

P. 33-36
MPX³ & MPX³
Accessories



P. 37
Reactors and power
factor controllers

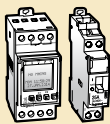

P. 45
DX³
Time switches
and Contactors

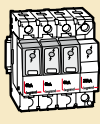

P. 47-48 **NEW!**
SPD

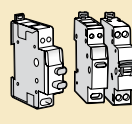

P. 49
DX³ changeover
switches,
Push buttons and
Indicators

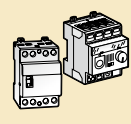

P. 49
Lexic dimmer and
Power contactors

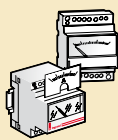

P. 49-50
Lexic ammeters
and Current
transformers



P. 50
Lexic voltmeters
and Selector
switches



P. 55
Ekinox³
VTPN DBs



P. 55
Ekinox³
VTPN MCCB
DBs



P. 55
Ekinox³
Phase Selector
DBs

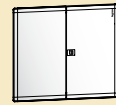

P. 56
Ekinox³
7 Segment
DBs



P. 57
Ekinox³
Metal
Enclosures

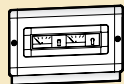

P. 57
Ekinox³
Cable end box,
Meter box, PPT Kit
& Accessories



P. 58
Ekinox³ DBs
Plexo 3 boxes for
DX³ and Accessories

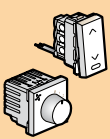

P. 78
TV Sockets,
Skirting light &
Power trip,
Switches, Push
buttons

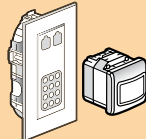

P. 78
Accessories
Square Champagne
Mechanism

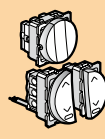

P. 79
Indian standard
sockets,
USB Chargers,
Data & voice

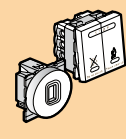

P. 79
Hotel Funtions
Square Champagne
& Round White
Mechanism

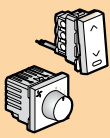

P. 82
Switches, Push
buttons, Dimmers &
Regulators, Plates
Round Champagne
Mechanism

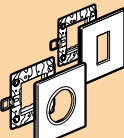

P. 82-86
Square cover plates,
Round cover plates

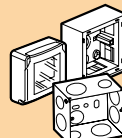

P. 86
Plastic surface,
Metal flush boxes,
Plexo boxes &
Accessories

P. 93-94
USB chargers
and Audio
& video connectors

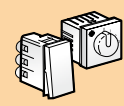

P. 95
Switches,
Push buttons,
Sockets,
Power units

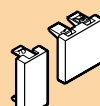

P. 93-94
Anti-Bacterial
Switches and
Accessories

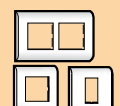

P. 96-97
White plastic
plates

P. 96
USB chargers
and Audio & video
connectors

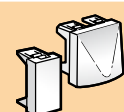



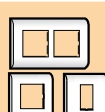



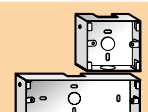



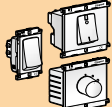
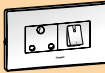
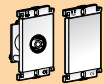
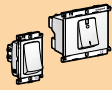

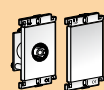

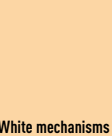

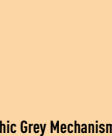

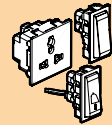
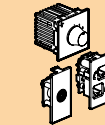
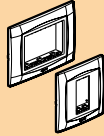
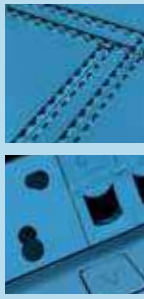
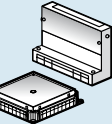
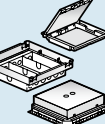
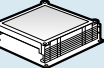

P. 96
Volume controller,
Protectors and
Accessories,
Modular MCBs

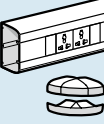

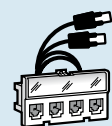
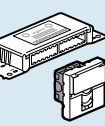
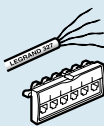
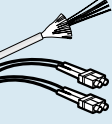
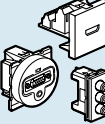
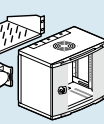
P. 97
Black plastic
plates

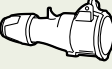
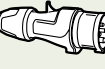

P. 97
Flush mounting &
Surface boxes

 <p>Mylicm™ Wiring Accessories</p>	 <p>P. 99-100 Mylicm switches, Dimmers and Accessories USB charger and remote unit</p>	 <p>P. 99 Mylicm energy sockets, Power units and MCBs</p>	 <p>P. 99 Mylicm TV and RJ 11 telephone sockets and Accessories</p>
	 <p>P. 100 Mylicm switches, Dimmers, USB charger, Remote unit & Accessories</p>	 <p>P.100 Mylicm energy sockets, Power units and MCBs</p>	 <p>P. 101 Mylicm TV, RJ 11 Telephone Sockets & Accessories</p>
 <p>Lyncus™ Wiring Accessories</p>	 <p>P. 106 <small>NEW!</small> Switches, Push buttons, Indian Standard Sockets</p>	 <p>P.106 <small>NEW!</small> Dimmer and regulators, Hospitality Functions</p>	 <p>P.107 <small>NEW!</small> Data voice, Pre terminated audio video connectors</p>
	 <p>P. 107-108 <small>NEW!</small> Switches, Push buttons, Dimmer and regulators, Accessories</p>	 <p>P.108 <small>NEW!</small> Hospitality Functions, Data voice, Pre terminated</p>	 <p>P. 108 <small>NEW!</small> Audio Video Connectors, USB chargers: Combi Sockets + USB</p>
 <p>Britzy™ Wiring Accessories</p>	 <p>P. 110 Britzy Switches, sockets and push buttons</p>	 <p>P. 110 Britzy Data & voice, television sockets, dimmers & regulators & accessories</p>	 <p>P. 111 Britzy white plate with frames</p>
 <p>Cable Management System and Accessories</p>	 <p>P. 114 Raceways & junction boxes for screed floors PVC, Metal and Accessories</p>	 <p>P. 114-115 Floor boxes for raised floor, Screed floor and tile/marble, Support Plates</p>	 <p>P. 115-116 Heavy Duty in-screed floor box, Floor Boxes 3 module, Floor access unit for raised floors</p>
	 <p>P. 121 Selection Chart: DLP Mini Trunking Systems</p>	 <p>P. 122 Selection Chart : DLP aluminium Trunking system</p>	 <p>P. 124 Snap-On Trunking 45 mm, Routing sections and Accessories</p>
 <p>VDI Structured Cabling</p>	 <p>P. 130 LCS³, cat. 8 Patch Panels</p>	 <p>P. 130 LCS³, cat. 8 Cables and Cords</p>	 <p>P. 130-132 LCS³, cat. 6A Patch panels, RJ 45, Cables and Cords</p>
	 <p>P. 139 LCS³, Audio/Video patch panel chord cables</p>	 <p>P. 140 9" fibre optic drawers, LCS³ fibre optic blocks</p>	 <p>P. 140 Modular Panels cassettes for LCS³ fibre optic drawers</p>
 <p>Movement Detectors and Door Phones</p>	 <p>P. 146 Movement detectors</p>	 <p>P. 146 Video door entry system</p>	
 <p>P17 Tempra Pro, Hypra and Plugs & Sockets</p>	 <p>P. 149-150 P17 Tempra Pro sockets</p>	 <p>P. 149-150 P17 Tempra Pro plugs</p>	 <p>P. 149-150 P17 Tempra Pro for refrigerated container</p>

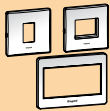

P. 100
Mylinc
Modular Plates -
White



P. 101
Mylinc modular plates-
Matt Grey, Pearl white,
Champagne, Silver Alu,
Dark Bronze

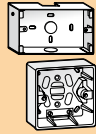

P. 102
Mylinc white
surrounds,
Flush & Surface
boxes

P. 107 NEW!
USB Chargers:
Combi sockets + USB,
Wireless charger

P.107 NEW!
Bluetooth sound
diffusion and loud
speakers, Universal
Dimmers

P.107 NEW!
Reading light,
Universal dimmers,
Touch switches,
Reading light

P. 108 NEW!
Wireless charger,
Bluetooth sound
diffusion and
Loud speakers

P. 108-109 NEW!
White plate
with frames

P. 109 NEW!
Plate & Frame
Chic grey, Brushed
silver, Alu sunset,
Champagne,
Matt silver

P. 109 NEW!
Metal Flush box &
Plastic surface
boxes

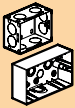

P. 111
Britzy Flush & surface
mounting boxes

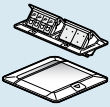

P. 116-117
Pop-up type flush-
mounting boxes,
Power & Data desk
grommets



P. 117
Flush Mounting
Power & data
module



P. 118
Selection Chart:
Snap-On trunking



P. 120
Selection chart:
DLP PVC
adaptable trunking
system

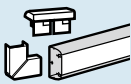

P. 124-125
DLP PVC Trunking
System, Trunking,
Mini-Trunking and
Accessories

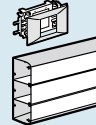

P. 126
DLP-S
PVC Trunking
system and Trunking
Accessories

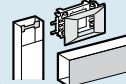

P. 126
DLP Aluminium
Adaptable Trunking
System, Aluminium
Snap-on columns

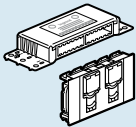

P. 132-135
LCS³,
cat. 6 Patch
Panels, RJ 45,
Cables and Cords

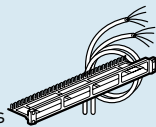

P. 135- 136
LCS³,
cat. 5e Patch
panels, Cables
and Cords, RJ45

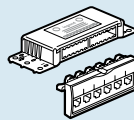

P. 136-137
LCS³,
cat. Splitter
sockets, adapters
and accessories

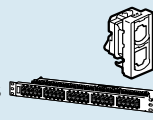

P. 137-139
LCS³, Audio/Video
Preterminated
sockets

P. 141
LCS³ pigtails, case
and quick-connect
connectors

P. 141-142
LCS³ High Density
and Very High
Density drawers
and cassettes

P. 142-143
LCS³
Preterminated fibre
optic and cable
solutions

P. 143-144
Patch chords



P. 151
Hypra industrial
plugs and sockets

Optimized performance up to 6300 A

DMX³ air circuit breakers are available in three frame sizes for three breaking capacities: 50 kA for the DMX³ N designation, 65 kA for DMX³ H and 100 kA for DMX³ L.

The range covers 11 rated currents, between 630 A and 6300 A.

The entire range of DMX³ air circuit breakers are available in fixed and draw-out version.

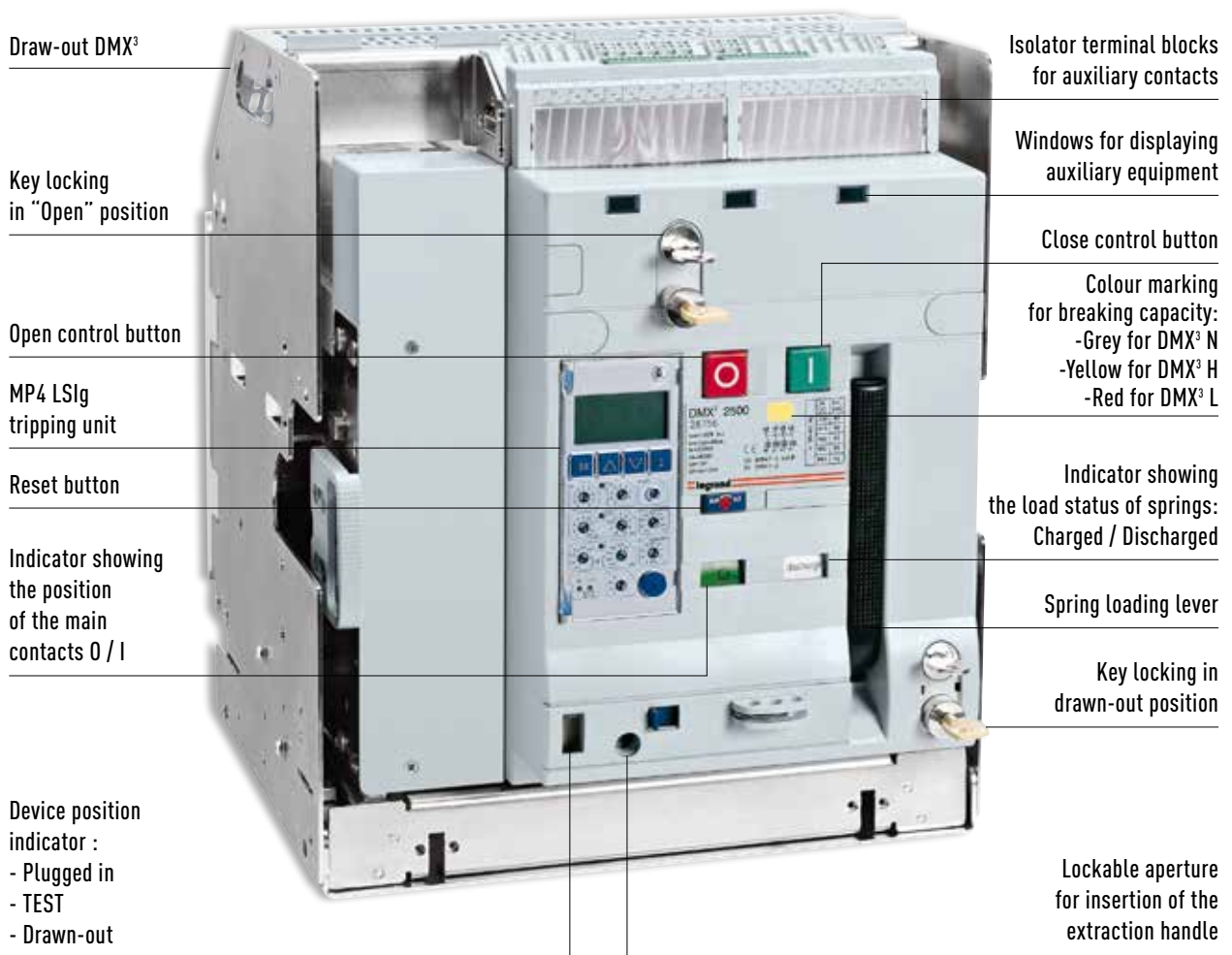

DMX³ Air Circuit Breakers



- Range – 630 A to 6300 A
- Three Optimum Frame Sizes
- Breaking Capacities of 50 kA, 65 kA & 100 kA
- Advanced Self Powered Electronic Protection Units
- Options for LSI and LSIG Trip Units
 - L : I_r – 0.4 to 1 I_n , t_r – 5 to 30 sec
 - S : I_{sd} – 1.5 to 10 I_r , t_{sd} – 0.1 to 1 sec
 - I : I_{li} – 2 to 15 I_n
 - G : 0.2 to 1 I_n , t_g – 0.1 to 1 sec
- Options of LCD and Touch Screen Multi Colour Displays
- Neutral Overload Protection – OFF-50 %-100 %
- Communication Ready
- In Built Temperature Protection
- Rotatable Terminals for Horizontal/Vertical Orientation
- Fast Operation
- Options to install various safety interlock
- Internal Battery for Trip Units
- Individual fault diagnosis
- Individual Fault Counter & Historical Trip Record
- 6 Programmable Digital Relay Contacts with Time Delay Changeover
- Option to Measure Current, Voltage, Frequency, Power , Energy, Power Factor and internal battery voltage
- Advanced Functions of Logical Selectivity, Reverse Power, Current Unbalance, Overvoltage, Undervoltage, Voltage Unbalance, Under Frequency, Over Frequency & Phase Reversal

Type and frame size	Rated Current (A)	3P			4P		
		Cat.Nos	MRP*/ ₹/Unit	Pack	Cat.Nos	MRP*/ ₹/Unit	Pack

Fixed Version

DMX ³ - N 2500, Icu 50 kA Frame - 1	630 A	0286 20	■	1	0286 30	■	1
	800 A	0286 21	■	1	0286 31	■	1
	1000 A	0286 22	■	1	0286 32	■	1
	1250 A	0286 23	■	1	0286 33	■	1
	1600 A	0286 24	■	1	0286 34	■	1
	2000 A	0286 25	■	1	0286 35	■	1
	2500 A	0286 26	■	1	0286 36	■	1
DMX ³ -N 4000 Icu 50 kA Frame - 2	3200 A	0286 27	■	1	0286 37	■	1
	4000 A	0286 28	■	1	0286 38	■	1
DMX ³ - H 2500, Icu 65 kA Frame - 1	630 A	0286 40	■	1	0286 50	■	1
	800 A	0286 41	■	1	0286 51	■	1
	1000 A	0286 42	■	1	0286 52	■	1
	1250 A	0286 43	■	1	0286 53	■	1
	1600 A	0286 44	■	1	0286 54	■	1
	2000 A	0286 45	■	1	0286 55	■	1
	2500 A	0286 46	■	1	0286 56	■	1
DMX ³ -H 4000 Icu 65 kA Frame - 2	3200 A	0286 47	■	1	0286 57	■	1
	4000 A	0286 48	■	1	0286 58	■	1
DMX ³ - L 2500, Icu 100 kA Frame - 2	630 A	0286 60	■	1	0286 70	■	1
	800 A	0286 61	■	1	0286 71	■	1
	1000 A	0286 62	■	1	0286 72	■	1
	1250 A	0286 63	■	1	0286 73	■	1
	1600 A	0286 64	■	1	0286 74	■	1
	2000 A	0286 65	■	1	0286 75	■	1
	2500 A	0286 66	■	1	0286 76	■	1
DMX ³ -L 4000 Icu 100 kA Frame - 2	3200 A	0286 67	■	1	0286 77	■	1
	4000 A	0286 68	■	1	0286 78	■	1
DMX ³ -L 6300 Icu 100 kA Frame - 3	5000 A	0289 50	■	1	0289 60	■	1
	6300 A	0289 51	■	1	0289 61	■	1

■ Price available on request.

* MRP - Maximum Retail Price Inclusive of all taxes including GST.

Bold Cat.Nos are products normally available with Legrand (India) Stockists. Cat.Nos that are not bold - delivery within 4 - 8 weeks from the date of order. **Bold packing quantity** is our mandatory packing. Orders to be placed by Legrand (India) Stockist in multiples of the same.



0286 37



0286 56

DMX³ Air Circuit Breakers

Type and frame size	Rated Current (A)	3P			4P		
		Cat.Nos	MRP*/ ₹/Unit	Pack	Cat.Nos	MRP*/ ₹/Unit	Pack

Draw - Out Version

DMX ³ - N 2500, Icu 50 kA Frame - 1	630 A	0287 20	■	1	0287 30	■	1
	800 A	0287 21	■	1	0287 31	■	1
	1000 A	0287 22	■	1	0287 32	■	1
	1250 A	0287 23	■	1	0287 33	■	1
	1600 A	0287 24	■	1	0287 34	■	1
	2000 A	0287 25	■	1	0287 35	■	1
	2500 A	0287 26	■	1	0287 36	■	1
DMX ³ -N 4000 Icu 50 kA Frame - 2	3200 A	0287 27	■	1	0287 37	■	1
	4000 A	0287 28	■	1	0287 38	■	1
DMX ³ - H 2500, Icu 65 kA Frame - 1	630 A	0287 40	■	1	0287 50	■	1
	800 A	0287 41	■	1	0287 51	■	1
	1000 A	0287 42	■	1	0287 52	■	1
	1250 A	0287 43	■	1	0287 53	■	1
	1600 A	0287 44	■	1	0287 54	■	1
	2000 A	0287 45	■	1	0287 55	■	1
DMX ³ -H 4000 Icu 65 kA Frame - 2	3200 A	0287 47	■	1	0287 57	■	1
	4000 A	0287 48	■	1	0287 58	■	1
DMX ³ - L 2500, Icu 100 kA Frame - 2	630 A	0287 60	■	1	0287 70	■	1
	800 A	0287 61	■	1	0287 71	■	1
	1000 A	0287 62	■	1	0287 72	■	1
	1250 A	0287 63	■	1	0287 73	■	1
	1600 A	0287 64	■	1	0287 74	■	1
	2000 A	0287 65	■	1	0287 75	■	1
DMX ³ -L 4000 Icu 100 kA Frame - 2	3200 A	0287 67	■	1	0287 77	■	1
	4000 A	0287 68	■	1	0287 78	■	1
DMX ³ -L 6300 Icu 100 kA Frame - 3	5000 A	0289 52	■	1	0289 62	■	1
	6300 A	0289 53	■	1	0289 63	■	1



0287 56

Switch Disconnecter (Trip Free Switches) from 1250 to 6300 A

Fixed Version

DMX ³ -I 2500 Frame - 1	1250 A	0286 83	■	1	0286 93	■	1
	1600 A	0286 84	■	1	0286 94	■	1
	2000 A	0286 85	■	1	0286 95	■	1
	2500 A	0286 86	■	1	0286 96	■	1
DMX ³ -I 4000 Frame - 2	3200 A	0286 87	■	1	0286 97	■	1
	4000 A	0286 88	■	1	0286 98	■	1
DMX ³ -I 6300 Frame - 3	6300 A	0289 70	■	1	0289 71	■	1



0286 96

Draw - Out Version

DMX ³ -I 2500 Frame - 1	1250 A	0287 83	■	1	0287 93	■	1
	1600 A	0287 84	■	1	0287 94	■	1
	2000 A	0287 85	■	1	0287 95	■	1
	2500 A	0287 86	■	1	0287 96	■	1
DMX ³ -I 4000 Frame - 2	3200 A	0287 87	■	1	0287 97	■	1
	4000 A	0287 88	■	1	0287 98	■	1
DMX ³ -I 6300 Frame - 3	6300 A	0289 77	■	1	0289 78	■	1



0287 96

* MRP - Maximum Retail Price Inclusive of all taxes including GST.
■ Price available on request.

Bold Cat.Nos are products normally available with Legrand (India) Stockists.
Cat.Nos that are not bold - delivery within 4 - 8 weeks from the date of order.
Bold packing quantity is our mandatory packing. Orders to be placed by Legrand (India) Stockist in multiples of the same.

DMX³

Electronic Protection Units

Cat.Nos	Description	MRP*/₹/Unit	Pack
---------	-------------	-------------	------

Electronic Protection Units MP4

0288 01	Electronic Protection Unit with LCD screen with Im, tm, Ir, tr and li adjustments on the front	■	1
0288 02	Electronic Protection Unit with LCD screen with Im, tm, Ir, tr, li, lg and tg adjustments on the front	■	1

Electronic Protection Units MP6

0288 03	Electronic Protection Unit with Touch screen with Im, tm, Ir, tr and li, adjustments on the front	■	1
0288 04	Electronic Protection Unit with Touch screen with Im, tm, Ir, tr, li, lg and tg adjustments on the front	■	1

Accessories for Electronic Protection Units

0288 05	Communication module (optional) for DMX ³ electronic protection units	■	1
0288 06	12 V DC external power supply for DMX ³ electronic protection units	■	1
0288 10	External neutral CT for DMX ³ 6300	■	1
0288 11 ⁽¹⁾	External neutral CT	■	1
0288 12	Module programmable output	■	1

Type and frame size	3P			4P		
	Cat.Nos	MRP*/₹/Unit	Pack	Cat.Nos	MRP*/₹/Unit	Pack

Fixed Version

DMX3 2500, fixed version, frame - 1	0288 84	■	1	0288 85	■	1
	0288 82	■	1	0288 83	■	1
DMX ³ 4000, DMX ³ 6300 fixed version, frame - 2 & 3	0288 92	■	1	0288 93	■	1
DMX ³ -L 4000 Icu 100 kA Frame - 2	0288 96	■	1	0288 97	■	1
DMX ³ 4000, DMX ³ 6300 draw-out version, fram - 2 & 3	0288 94	■	1	0288 95	■	1
DMX ³ 2500, draw-out version, frame-1 suitable for Aluminium	0288 96A	■	1	0288 97A	■	1
DMX ³ 4000, DMX ³ 6300 draw-out version, frame - 2&3, suitable for Aluminium	0288 94A	■	1	0288 95A	■	1

Spreaders

DMX ³ 2500, fixed version, frame - 1	0289 02	■	1	0288 87	■	1
	0288 88	■	1	0288 89	■	1
	0288 90	■	1	0288 91	■	1

Equipment for conversion of a fixed device into draw-out device

Bases (cradle) for Draw-Out Device

DMX ³ /DMX ³ -I 2500, frame - 1	0289 02	■	1	0289 03	■	1
DMX ³ /DMX ³ -I 2500, frame - 1	0289 04	■	1	0289 05	■	1
DMX ³ /DMX ³ -I 2500, frame - 1	0289 13	■	1	0289 14	■	1

Transformation kit for Draw-Out Version

DMX ³ /DMX ³ -I 2500, frame - 1	0289 09	■	1	0289 10	■	1
DMX ³ /DMX ³ -I 4000, frame - 2	0289 11	■	1	0289 12	■	1
DMX ³ /DMX ³ -I 6300, frame - 3	0289 15	■	1	0289 16	■	1

* MRP - Maximum Retail Price Inclusive of all taxes including GST.

■ Price available on request.

(1) Optional accessories to be ordered while ordering electronic protection unit and DMX³ air circuit breakers for factory assembly

Bold Cat.Nos are products normally available with Legrand (India) Stockists. Cat.Nos that are not bold - delivery within 4 - 8 weeks from the date of order. Bold packing quantity is our mandatory packing. Orders to be placed by Legrand (India) Stockist in multiples of the same.

DMX³ Auxiliaries and Accessories

Cat.Nos	Description	MRP* ₹ / Unit	Pack
---------	-------------	------------------	------

Control and signalling auxiliaries

Shunt trip

0288 48	24 V \sim /=	■	1
0288 49	48 V \sim /=	■	1
0288 50	110 V \sim /=	■	1
0288 51	230 V \sim /=	■	1
0288 52	415 V \sim	■	1



0288 51

Undervoltage Releases

0288 55	24 V \sim /=	■	1
0288 56	48 V \sim /=	■	1
0288 57	110 V \sim /=	■	1
0288 58	230 V \sim /=	■	1
0288 59	415 V \sim	■	1



0288 58

Undervoltage Releases with Relay

0288 62	110 V \sim /=	■	1
0288 63	230 V \sim /=	■	1

Motor operators

0288 34	24 V \sim /=	■	1
0288 35	48 V \sim /=	■	1
0288 36	110 V \sim /=	■	1
0288 37	230 V \sim /=	■	1
0288 38	415 V \sim	■	1



0288 37

Closing coils

0288 41	24 V \sim /=	■	1
0288 42	48 V \sim /=	■	1
0288 43	110 V \sim /=	■	1
0288 44	230 V \sim /=	■	1
0288 45	415 V \sim	■	1



0288 44

Locking

Key locking in "open" position

0288 31	Ronis lock (key included)	■	1
0288 29	Ronies key barrel	■	1
0288 30	Profalux lock (key included)	■	1
0288 28	2 hole support frame for Ronis locks	■	1



0288 32
+
0288 33

DMX³ Auxiliaries and Accessories

Cat.Nos	Description	MRP* ₹ / Unit	Pack
---------	-------------	------------------	------

Locking

Key locking in the draw-out position

0288 33	Ronis lock (key included)	■	1
0288 32	Profalux lock (key included)	■	1

Door locking

0288 20	Left-hand and right-hand side mounting	■	1
---------	--	---	---

Padlocks in "open" position

0288 21	Padlocking system for ACB	■	1
0288 24	Padlocking for button	■	1
0288 26	Padlocking system for shutters	■	1

Automation control unit

4226 80	Standard unit	■	1
4226 82	Advanced unit	■	1
4226 89*	Communication module	■	1



4226 82

Equipment for supply invertors

0288 64	Interlock for DMX ³ 2500	■	1
0288 65	Interlock for DMX ³ 4000	■	1
0288 66	Interlock for DMX ³ 6300	■	1



0288 64

Cable interlock

0289 20	Type 1 (2600 mm)	■	1
0289 21	Type 2 (3000 mm)	■	1
0289 22	Type 3 (3600 mm)	■	1
0289 23	Type 4 (4000 mm)	■	1
0289 24	Type 5 (4600 mm)	■	1
0289 25	Type 6 (5600 mm)	■	1

Accessories

0288 25	Rating mis-insertion device	■	1
0288 23	Operations counter	■	1
0288 13	Inserted / test / Draw-out Contact	■	1
0288 14	Contact "ready to close" with charged springs	■	1
0288 15	Set of additional signalling contacts	■	1
0288 16	Signal Contact for Auxiliaries	■	1
0288 22	Door sealing IP 40	■	1
0288 79	Lifting plate	■	1

* MRP - Maximum Retail Price Inclusive of all taxes including GST.
■ Price available on request.
▼ For communication add 422682 + 422689

Bold Cat.Nos are products normally available with Legrand (India) Stockists. Cat.Nos that are not bold - delivery within 4 - 8 weeks from the date of order. Bold packing quantity is our mandatory packing. Orders to be placed by Legrand (India) Stockist in multiples of the same.

DMX SP 2500 Air Circuit Breakers

NEW!



- Range – 630 A to 2500 A
- Single Frame Size
- Options of Fixed and Drawout Versions
- Options of Manual & Electrical Versions
- Icu=Ics=Icw(1s)=50 kA
- Compact Dimensions
- Advanced Self Powered Electronic Protection Units
- Options of LSI and LSIG Protections
 - L : Ir – 0.4 to 1 In, tr – 5 to 30 sec
 - S : I_{sd} – 1.5 to 10 I_r, t_{sd} – 0.1 to 1 sec
 - I : I_{li} – 2 to 15 I_n
 - G – 0.2 to 1 In, t_g – 0.1 to 1 sec
- Neutral Overload Protection - OFF-50 %-100 %
- In Built Temperature Protection
- Rotatable Terminals for Horizontal/Vertical Orientation
- Fast Operation
- Options to install various safety interlock

Type and frame size	Rated Current (A)	3P			4P		
		Cat.Nos	MRP* / ₹/Unit	Pack	Cat.Nos	MRP* / ₹/Unit	Pack

Fixed version

DMX SP 2500 Icu = 50 kA	630A	6695 24	80216	1	6695 30	111730	1
	800A	6695 25	80216	1	6695 31	111730	1
	1000A	6695 26	85944	1	6695 32	120326	1
	1250A	6695 27	101702	1	6695 33	140376	1
	1600A	6695 28	120326	1	6695 34	157570	1
	2000A	6695 29	144102	1	6695 35	189310	1



6695 26



6695 31

Drawout version

DMX SP 2500 Icu = 50 kA	630A	6695 36	103132	1	6695 42	134646	1
	800A	6695 37	103132	1	6695 43	134646	1
	1000A	6695 38	108868	1	6695 44	143244	1
	1250A	6695 39	124624	1	6695 45	163298	1
	1600A	6695 40	143244	1	6695 46	180486	1
	2000A	6695 41	177624	1	6695 47	211168	1

Switch Disconnectors / Trip Free Switches

Fixed version

DMX SP 2500 Icu = 50 kA	630A	6695 48	80216	1	6695 54	111730	1
	800A	6695 49	80216	1	6695 55	111730	1
	1000A	6695 50	85944	1	6695 56	120326	1
	1250A	6695 51	101702	1	6695 57	140376	1
	1600A	6695 52	120326	1	6695 58	157570	1
	2000A	6695 53	144102	1	6695 59	189310	1

Drawout version

DMX SP 2500 Icu = 50 kA	630A	6695 60	103132	1	6695 66	134646	1
	800A	6695 61	103132	1	6695 67	134646	1
	1000A	6695 62	108868	1	6695 68	143244	1
	1250A	6695 63	124624	1	6695 69	163298	1
	1600A	6695 64	143244	1	6695 70	180486	1
	2000A	6695 65	177624	1	6695 71	211168	1



6695 68

* MRP - Maximum Retail Price Inclusive of all taxes including GST.
Red Cat.Nos - new products

Bold Cat.Nos are products normally available with Legrand (India) Stockists.
Cat.Nos that are not bold - delivery within 4 - 8 weeks from the date of order.
Bold packing quantity is our mandatory packing. Orders to be placed by Legrand (India) Stockist in multiples of the same.

DMX SP 2500

Electronic Protection Units

NEW!

Cat.Nos	Description	MRP* ₹ / Unit	Pack
---------	-------------	------------------	------

Electronic Protection Units

0281 67	Electronic Protection Unit MP2 LSI	18624	1
0281 68	Electronic Protection Unit MP2 LSIg	22918	1

Auxilliaris Accessories

Motor operator

0281 20	24V ~/=	27216	1
0281 21	48V ~/=	27216	1
0281 22	110-130V ~/=	27216	1
0281 23	220-250V ~/=	27216	1
0281 24	415-440V ~	27216	1

Closing coil

0281 26	24V ~/=	4584	1
0281 27	48V ~/=	4584	1
0281 28	110-130V ~/=	4584	1
0281 29	220-250V ~/=	4584	1
0281 30	415-440V ~	4584	1

Shunt release

0281 31	24V ~/=	4584	1
0281 32	48V ~/=	4584	1
0281 33	110-130V ~/=	4584	1
0281 34	220-250V ~/=	4584	1
0281 35	415-440V ~	4584	1

Undervoltage release

0281 36	24V ~/=	6016	1
0281 37	48V ~/=	6016	1
0281 38	110-130V ~/=	6016	1
0281 39	220-250V ~/=	6016	1
0281 40	415-440V ~	6016	1

Undervoltage Release with Time Delay

0288 62	110V ~/=	9170	1
0288 63	230V ~/=	9170	1

Mechanical Accessories

Phase barriers / Insulated shields

6696 00	Fix Version 3P DMX SP	■	1
6696 01	Fix Version 4P DMX SP	■	1
6696 02	Draw-out Version 3P DMX SP	■	1
6696 03	Draw-out Version 4P DMX SP	■	1

DMX³

Auxilliaris Accessories

NEW!

Cat.Nos	Description	MRP* ₹ / Unit	Pack
---------	-------------	------------------	------

Key lock

0281 78	Keylock in open position (1 lock 1 Ronis random) Frame 2500	3726	1
0281 79	Keylock in open position (1 lock 1 Ronis type "A") Frame 2500	3726	1
0281 80	Keylock in open position (1 lock 1 Ronis type "B") Frame 2500	3726	1
0281 81	Keylock in open position - Profalux DMX SP	3726	1
0281 82	Keylock ins./test/drawnout - Profalux DMX SP	3726	1
0281 83	Keylock ins./test/drawnout - Ronis DMX SP	3726	1
0281 84	Door lock for both right & left handle Frame 2500	3726	1
0281 87	Inserted/test/drawnout lock button	1718	1

Terminals

0288 84	Real terminals - flat connections with bars	■	1
0288 82	Real terminals - vertical connections with bars	■	1
0288 85	Real terminals - flat connections with bars	■	1
0288 83	Real terminals - vertical connections with bars	■	1
0288 96	Real terminals - vertical or horizontal connection with bars to be fixed onto plate	6296	1
0288 97	Real terminals - vertical or horizontal connection with bars to be fixed onto plate	8394	1

Additional Accessories

0281 88	Mechanical Counter	2868	1
0281 77	Padlock for Button	1144	1
6696 05	Enternal Neutral	5565	1
0281 72	Power Supply 24V DC	11458	1
0281 73	Signalling Contact inserted- test-D/O	2290	1
0281 74	AUX Ready to close- charged springs	2290	1
0281 75	Module with 6 aux contacts	17188	1
0281 90	Mechanical Interlock two device	9190	1

■ Price available on request.

* MRP - Maximum Retail Price Inclusive of all taxes including GST.

Red Cat.Nos - new products

Bold Cat.Nos are products normally available with Legrand (India) Stockists. Cat.Nos that are not bold - delivery within 4 - 8 weeks from the date of order. Bold packing quantity is our mandatory packing. Orders to be placed by Legrand (India) Stockist in multiples of the same.

MCCBs: DRX™ and DPX³

Legrand now has two distinct ranges of MCCBs

DRX™ -- Thermal magnetic release only.

DPX³ -- Thermal magnetic and Microprocessor releases.

DRX™, is available upto 100 A, and finds applications in both, residential and commercial. Accessories like the Rotary Handles, Moulded Shrouds, Cage Terminals etc. are available in the range.



DRX 100

Current rating from 60 to 100 A
Breaking Capacity 10 kA
Thermal Magnetic release

DPX³ available in 5 frame sizes, covers requirements from 16 A upto 1600 A, with adjustable thermal and magnetic releases. Optional accessories like Rotary Handles, Motor Operators etc. are also available. **DPX³** can also be used as an Automatic Transfer Switch (Source transfer S/W) $I_{cs} = 100\% I_{cu}$



DPX³ 160

Current rating from 16 to 160 A
Breaking capacity 16 kA to 50 kA
Thermal magnetic release
Optional integrated earth leakage available



DPX³ 250

Current rating 40 Amp to 250 Amp
Breaking capacity 25 kA to 70 kA
Thermal magnetic release & microprocessor release
Optional integrated earth leakage available



DPX³ 630

Thermal Magnetic & Electronic type
Current rating – 320 A to 630 A
Breaking capacity – 36 kA to 100 kA



DPX³ 1600

Thermal Magnetic & Electronic type
Current rating – 800 A to 1600 A
Breaking capacity – 36kA to 100 kA

DRX™ MCCB

Type and frame size	Rated Current (A)	Poles	Cat.Nos	MRP* ₹ / Unit	Pack
---------------------	-------------------	-------	---------	---------------	------

DRX MCCBs

DRX 100 Icu = 10 kA	63 A	3 Pole	0270 39	2362	1/12
	75 A	3 Pole	0270 07	2362	1/12
	100 A	3 Pole	0270 08	2362	1/12
	63 A	4 Pole	0270 29	3694	1/12
	75 A	4 Pole	0270 17	3694	1/12
	100 A	4 Pole	0270 18	3694	1/12

Description	Cat.Nos	MRP* ₹ / Unit	Pack
-------------	---------	---------------	------

DIN rail adaptor

DRX 100	0271 87	396	1
---------	---------	-----	---

Rotary handles - Direct

DRX 100	6687 70	1190	1
---------	---------	------	---

Rotary handles - vary-depth

DRX 100	6687 71	2060	1
---------	---------	------	---

Padlocking support for operating handle

DRX 100	0271 80	132	1
---------	---------	-----	---

Connection accessories

Set of 2 shields for 3 pole	0271 81	94	1
-----------------------------	---------	----	---

Sealable terminal shields (moulded shrouds)

For DRX 100 - 3 pole	0271 83	1296	1
For DRX 100 - 4 pole	0271 84	1294	1

Cage terminals

For DRX 100 - 3 pole	0271 71	252	1
For DRX 100 - 4 pole	0271 73	264	1

Electrical accessories

Block with 1 auxiliary (1 AUX)	0271 40	822	1
Block with 1 alarm (1 AL)	0271 41	840	1
Block with 1 auxiliary + 1 alarm (1 AUX + 1 AL)	0271 42	1380	1

Current shunt coils

200/277 V \sim and =	0271 54	1714	1
380/480 V \sim and =	0271 55	1714	1

Undervoltage release coils

200/240 V \sim	0271 64	1986	1
380/415 V \sim	0271 65	2016	1

DRX spreader links

3 Links set for TP	6250 10	170	1
4 Links set for FP	6250 11	254	1

* MRP - Maximum Retail Price Inclusive of all taxes including GST.
Red Cat.Nos - new products

P17 TEMPRA PRO

Ensuring a quick installation

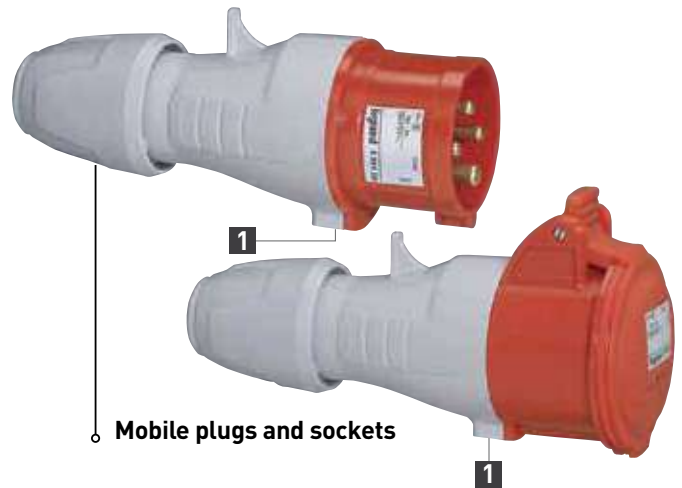

Mobile plugs and sockets

1 QUICK OPENING/CLOSING SYSTEM

Unlocked by pressing with a screwdriver. Marking indicates the location for the locking clip. Opened by turning the 2 parts in opposite directions.

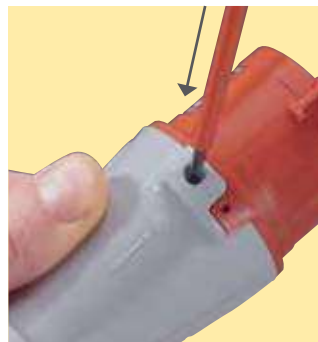

0270 08



0271 83



0271 40



0271 54

DPX³ MCCB

DPX³ MCCB with Thermal Magnetic Protection Unit

- Range: 16A – 1250A, **Ics=100%Icu**, Four Optimum Frames
- Thermal Adjustable – 0.8 to 1In, Magnetic Adjustable** – 5 to 10In
- Breaking Capacity# – 16kA, 25kA, 36kA, 50kA, 70kA & 100kA
- **Option for In built or add on module for Earth Leakage Protection##**
 - Adjustable sensitivity: 0.03 - 0.3 - 1 - 3 A
 - Adjustable tripping: 0 - 0.3 - 1 - 3s
- Suitable for Isolation

Category	Type	Rated Current (A)	3P			4P		
			Cat.No	MRP*/₹ /Unit	Pack	Cat.No	MRP*/₹ /Unit	Pack

Thermal Magnetic : O/L & S/C protection

16 KA	DPX ³ 160	16	4200 00	5670	1	4200 10	7520	1
		25	4200 01	5670	1	4200 11	7520	1
		40	4200 02	5670	1	4200 12	7520	1
		63	4200 03	5670	1	4200 13	7520	1
		80	4200 04	5670	1	4200 14	7520	1
		100	4200 05	5670	1	4200 15	7520	1
		125	4200 06	6250	1	4200 16	7900	1
		160	4200 07	8300	1	4200 17	10450	1
25 KA	DPX ³ 160	16	4200 40	5950	1	4200 50	8350	1
		25	4200 41	5950	1	4200 51	8350	1
		40	4200 42	5950	1	4200 52	8350	1
		63	4200 43	5950	1	4200 53	8350	1
		80	4200 44	5950	1	4200 54	8350	1
		100	4200 45	5950	1	4200 55	8350	1
		125	4200 46	8900	1	4200 56	10800	1
		160	4200 47	11900	1	4200 57	13750	1
	DPX ³ 250	200	4202 08	15326	1	4202 18	18516	1
		250	4202 09	17766	1	4202 19	23938	1
36 KA	DPX ³ 160	16	4200 80	7700	1	4200 90	9250	1
		25	4200 81	7700	1	4200 91	9250	1
		40	4200 82	7700	1	4200 92	9250	1
		63	4200 83	7700	1	4200 93	9250	1
		80	4200 84	7700	1	4200 94	9250	1
		100	4200 85	7700	1	4200 95	9250	1
		125	4200 86	9000	1	4200 96	12250	1
		160	4200 87	12100	1	4200 97	13850	1
	DPX ³ 250	200	4202 38	19252	1	4202 48	25560	1
		250	4202 39	21366	1	4202 49	27372	1
	DPX ³ 630	320	4220 01	24302	1	4220 06	28980	1
		400	4220 02	24302	1	4220 07	29616	1
		500	4220 03	30064	1	4220 08	37546	1
		630	4220 04	30064	1	4220 09	38508	1
		800	4222 52	46112	1	4222 57	51876	1
		1000	4222 53	60186	1	4222 58	76086	1
50 KA	DPX ³ 160	1250	4222 54	86000	1	4222 59	91534	1
		16	4201 20	9350	1	4201 30	11850	1
		25	4201 21	9350	1	4201 31	11850	1
		40	4201 22	9350	1	4201 32	11850	1
		63	4201 23	9350	1	4201 33	11850	1
		80	4201 24	9350	1	4201 34	11850	1
		100	4201 25	9350	1	4201 35	11850	1
		125	4201 26	12600	1	4201 36	15100	1
	DPX ³ 250	160	4201 27	14750	1	4201 37	15600	1
		200	4202 68	21668	1	4202 78	27372	1
	DPX ³ 630	250	4202 69	22874	1	4202 79	28470	1
		320	4220 15	25652	1	4220 20	31264	1
		400	4220 16	26204	1	4220 21	31264	1
		500	4220 17	33348	1	4220 22	42114	1
630		4220 18	33348	1	4220 23	43182	1	
800		4222 64	47214	1	4222 69	57640	1	
DPX ³ 1600	1000	4222 65	73646	1	4222 70	86462	1	
	1250	4222 66	108192	1	4222 71	115282	1	

* MRP - Maximum Retail Price Inclusive of all taxes including GST.
MCCB Prices are without spreaders. For ordering spreaders refer page no. 21
** Fixed at 10In for DPX³ 160
Refer Catalogue for frame wise data
For DPX³ 160, DPX³ 250 and DPX³ 630 Only

Bold Cat.Nos are products normally available with Legrand (India) Stockists.
Cat.Nos that are not bold - delivery within 4 - 8 weeks from the date of order.
Bold packing quantity is our mandatory packing. Orders to be placed by Legrand (India) Stockist in multiples of the same.

DPX³ MCCB

Category	Type	Rated Current (A)	3P			4P		
			Cat.No	MRP*/₹ /Unit	Pack	Cat.No	MRP*/₹ /Unit	Pack

Thermal Magnetic : O/L & S/C protection

70 KA	DPX ³ 250	100	4206 05	19566	1	4206 15	21596	1
		160	4206 07	24446	1	4206 17	30394	1
		200	4206 08	30100	1	4206 18	37036	1
		250	4206 09	31984	1	4206 19	38554	1
		320	4220 29	32676	1	4220 34	40470	1
	DPX ³ 630	400	4220 30	32682	1	4220 35	40470	1
		500	4220 31	42622	1	4220 36	54910	1
		630	4220 32	44794	1	4220 37	54910	1
		800	4222 76	78100	1	4222 81	90542	1
		1000	4222 77	118268	1	4222 82	167454	1
	DPX ³ 1600	1250	4222 78	126006	1	4222 83	193092	1



4222 78



4222 83

Thermal Magnetic + Electronic earth leakage module

16 KA	DPX ³ 160	16	-	-	-	4200 30	25820	1	
		25	-	-	-	4200 31	25820	1	
		40	-	-	-	4200 32	25820	1	
		63	-	-	-	4200 33	25820	1	
		80	-	-	-	4200 34	25820	1	
		100	-	-	-	4200 35	25820	1	
		125	-	-	-	4200 36	27236	1	
		160	-	-	-	4200 37	33226	1	
25 KA	DPX ³ 160	16	-	-	-	4200 70	32406	1	
		25	-	-	-	4200 71	32406	1	
		40	-	-	-	4200 72	32406	1	
		63	-	-	-	4200 73	32406	1	
		80	-	-	-	4200 74	32406	1	
		100	-	-	-	4200 75	32406	1	
		125	-	-	-	4200 76	32418	1	
		160	-	-	-	4200 77	38270	1	
	DPX ³ 250	100	-	-	-	4202 25	43636	1	
		160	-	-	-	4202 27	45868	1	
36 KA	DPX ³ 160	16	-	-	-	4201 10	33786	1	
		25	-	-	-	4201 11	33786	1	
		40	-	-	-	4201 12	33786	1	
		63	-	-	-	4201 13	33786	1	
		80	-	-	-	4201 14	33786	1	
		100	-	-	-	4201 15	33786	1	
		125	-	-	-	4201 16	33970	1	
		160	-	-	-	4201 17	40404	1	
	DPX ³ 250	100	-	-	-	4202 55	43380	1	
		160	-	-	-	4202 57	50528	1	
		200	-	-	-	4202 58	52996	1	
		250	-	-	-	4202 59	56670	1	
50KA	DPX ³ 160	16	-	-	-	4201 50	38038	1	
		25	-	-	-	4201 51	38038	1	
		40	-	-	-	4201 52	38038	1	
		63	-	-	-	4201 53	38038	1	
		80	-	-	-	4201 54	38038	1	
		100	-	-	-	4201 55	38038	1	
		125	-	-	-	4201 56	40528	1	
		160	-	-	-	4201 57	43376	1	
		DPX ³ 250	100	-	-	-	4202 85	50612	1
			160	-	-	-	4202 87	58584	1
	200		-	-	-	4202 88	61724	1	
	250		-	-	-	4202 89	65580	1	



4202 25



4201 57

* MRP - Maximum Retail Price Inclusive of all taxes including GST.
MCCB Prices are without spreaders. For ordering spreaders refer page no. 21

Bold Cat.Nos are products normally available with Legrand (India) Stockists.
Cat.Nos that are not bold - delivery within 4 - 8 weeks from the date of order.
Bold packing quantity is our mandatory packing. Orders to be placed by Legrand (India) Stockist in multiples of the same.

DPX³ MCCB

DPX³ MCCB with Electronic S2* (LSI)* Protection Unit

- Range: 40A – 1600A, **Ics=100%Icu**, Three Optimum Frames
- **Protection against overloads:**
 - Ir adjustable from 0.4 to 1 x In
 - tr adjustable from 3 to 30s#
- **Protection against short circuits:**
 - I_{sd} adjustable from 1.5 to 10 x Ir
 - t_{sd} adjustable from 0 to 0.5s
- **Inbuilt Instantaneous Protection:**
 - Ii# – Fixed
- **Option for In built or add on module for Earth Leakage Protection##**
 - Adjustable sensitivity: 0.03 - 0.3 - 1 - 3 A
 - Adjustable tripping: 0 - 0.3 - 1 - 3s
- Breaking Capacity# – 25kA, 36kA, 50kA, 70kA & 100kA
- In built Display for Current Metering with accuracy of class 1
- Internal Battery with battery measure function
- Communication Ready via COMM Port
- Logical Selectivity Ready (Zone Selective Interlocking)
- Dynamic Selectivity as per Selectivity Charts
- In Built USB Port for Software Diagnosis
- Suitable for Isolation



Category	Type	Rated Current (A)	3P			4P		
			Cat.No	MRP*/ ₹ /Unit	Pack	Cat.No	MRP*/ ₹ /Unit	Pack

Electronic S2

25 KA	DPX ³ 250	40	4203 02	15192	1	4203 12	19948	1
		100	4203 05	15192	1	4203 15	19948	1
		160	4203 07	19684	1	4203 17	23542	1
		250	4203 09	25670	1	4203 19	33120	1
36 KA	DPX ³ 250	40	4203 32	16170	1	4203 42	19930	1
		100	4203 35	16170	1	4203 45	19930	1
		160	4203 37	20264	1	4203 47	27038	1
		250	4203 39	27148	1	4203 49	37140	1
	DPX ³ 630	320	4220 57	30722	1	4220 62	38348	1
		400	4220 58	30722	1	4220 63	37546	1
		500	4220 59	34376	1	4220 64	46110	1
		630	4220 60	35096	1	4220 65	47080	1
		800	4223 00	56946	1	4223 06	70322	1
		1000	4223 01	87192	1	4223 07	128662	1
50 KA	DPX ³ 250	1250	4223 02	105066	1	4223 08	156496	1
		1600	4223 03	130026	1	4223 09	174652	1
		40	4203 62	19632	1	4203 72	25738	1
		100	4203 65	19632	1	4203 75	25738	1
	DPX ³ 630	160	4203 67	23706	1	4203 77	28306	1
		250	4203 69	31632	1	4203 79	38288	1
		320	4220 67	33918	1	4220 72	43256	1
		400	4220 68	33918	1	4220 73	43256	1
70 KA	DPX ³ 1600	500	4220 69	39628	1	4220 74	49536	1
		630	4220 70	39628	1	4220 75	49536	1
		800	4223 12	65230	1	4223 18	87958	1
		1000	4223 13	90728	1	4223 19	126450	1
	DPX ³ 250	1250	4223 14	110094	1	4223 20	160478	1
		1600	4223 15	154190	1	4223 21	196038	1
		40	4206 35	26264	1	4206 45	34744	1
		100	4206 37	26264	1	4206 47	34744	1
DPX ³ 630	160	4206 38	40144	1	4206 48	46120	1	
	250	4206 39	45836	1	4206 49	59156	1	
	320	4220 77	44652	1	4220 82	57638	1	
	400	4220 78	44652	1	4220 83	57638	1	
	500	4220 79	50806	1	4220 84	64792	1	
	630	4220 80	50806	1	4220 85	64792	1	
	800	4223 24	88376	1	4223 30	111842	1	
	1000	4223 25	123846	1	4223 31	176750	1	
	DPX ³ 1600	1250	4223 26	148312	1	4223 32	206206	1
		1600	4223 27	199372	1	4223 33	255292	1

* MRP - Maximum Retail Price Inclusive of all taxes including GST.
MCCB Prices are without spreaders. For ordering spreaders refer page no. 21
Refer Catalogue for frame wise data
For DPX³ 250 and DPX³ 630 Only

Bold Cat.Nos are products normally available with Legrand (India) Stockists.
Cat.Nos that are not bold - delivery within 4 - 8 weeks from the date of order.
Bold packing quantity is our mandatory packing. Orders to be placed by Legrand (India) Stockist in multiples of the same.

DPX³ MCCB

DPX³ MCCB with Electronic Sg (LSIg) Protection Unit

- Range: 40A – 1600A, **Ics=100%Icu**, Three Optimum Frames
- **Protection against Overloads:**
 - Ir adjustable from 0.4 to 1 x In
 - tr adjustable from 3 to 30s[#]
- **Protection against Short Circuits:**
 - I_{sd} adjustable from 1.5 to 10 x Ir
 - t_{sd} adjustable from 0 to 0.5s
- **Inbuilt Instantaneous Protection:**
 - Ii[#] – Fixed
- **Protection against Ground Fault:**
 - I_g adjustable from 0.2 to 1 In & OFF
 - t_g adjustable from 0.1 to 1s
- **Option for In built or add on module for Earth Leakage Protection^{##}**
 - Adjustable sensitivity: 0.03 - 0.3 - 1 - 3 A
 - Adjustable tripping: 0 - 0.3 - 1 - 3s
- Breaking Capacity[#]– 25kA, 36kA, 50kA, 70kA & 100kA
- In built Display for Current Metering with high accuracy of class 1
- Internal Battery with battery measure function
- Communication Ready via COMM Port
- Logical Selectivity Ready (Zone Selective Interlocking)
- Dynamic Selectivity as per Selectivity Charts
- In Built USB Port for Software Diagnosis
- Switchable Thermal Memory
- Suitable for Isolation



Category	Type	Rated Current (A)	3P			4P		
			Cat.No	MRP*/ ₹ /Unit	Pack	Cat.No	MRP*/ ₹ /Unit	Pack

Electronic Sg

25 KA	DPX ³ 250	40	4205 02	33042	1	4205 12	36984	1	
		100	4205 05	33042	1	4205 15	36984	1	
		160	4205 07	36764	1	4205 17	40760	1	
		250	4205 09	40642	1	4205 19	47554	1	
36 KA	DPX ³ 250	40	4205 22	33796	1	4205 32	38072	1	
		100	4205 25	33796	1	4205 35	38072	1	
		160	4205 27	37318	1	4205 37	39582	1	
		250	4205 29	38326	1	4205 39	40590	1	
	DPX ³ 630	320	4221 37	42618	1	4221 42	46204	1	
		400	4221 38	42618	1	4221 43	46204	1	
		500	4221 39	46576	1	4221 44	56048	1	
		630	4221 40	46576	1	4221 45	56048	1	
		DPX ³ 1600	800	4223 96	84154	1	4224 02	101446	1
			1000	4223 97	111824	1	4224 03	147136	1
			1250	4223 98	125656	1	4224 04	175228	1
			1600	4223 99	137184	1	4224 05	207506	1
50 KA	DPX ³ 250	40	4205 42	35054	1	4205 52	38744	1	
		100	4205 45	35054	1	4205 55	38744	1	
		160	4205 47	38576	1	4205 57	40760	1	
		250	4205 49	39582	1	4205 59	47754	1	
	DPX ³ 630	320	4221 47	43750	1	4221 52	52074	1	
		400	4221 48	43930	1	4221 53	52074	1	
		500	4221 49	49844	1	4221 54	62862	1	
		630	4221 50	49844	1	4221 55	62862	1	
		DPX ³ 1600	800	4224 08	94614	1	4224 14	105598	1
			1000	4224 09	127056	1	4224 15	161048	1
			1250	4224 10	129980	1	4224 16	181452	1
			1600	4224 11	138684	1	4224 17	213214	1
	70 KA	DPX ³ 250	40	4206 92	45846	1	4207 02	51966	1
			100	4206 95	45846	1	4207 05	51966	1
			160	4206 97	56752	1	4207 07	61292	1
			250	4206 99	58122	1	4207 09	64500	1
DPX ³ 630		320	4221 57	57522	1	4221 62	70970	1	
		400	4221 58	57522	1	4221 63	70970	1	
		500	4221 59	66228	1	4221 64	90124	1	
		630	4221 60	66228	1	4221 65	90124	1	
		DPX ³ 1600	800	4224 20	100136	1	4224 26	120764	1
			1000	4224 21	139970	1	4224 27	216540	1
			1250	4224 22	185708	1	4224 28	250676	1
			1600	4224 23	250762	1	4224 29	295514	1

* MRP - Maximum Retail Price Inclusive of all taxes including GST.
MCCB Prices are without spreaders. For ordering spreaders refer page no. 21
Refer Catalogue for frame wise data
For DPX³ 250 and DPX³ 630 Only

Bold Cat.Nos are products normally available with Legrand (India) Stockists.
Cat.Nos that are not bold - delivery within 4 - 8 weeks from the date of order.
Bold packing quantity is our mandatory packing. Orders to be placed by
Legrand (India) Stockist in multiples of the same.

DPX³ MCCB

DPX³ MCCB with Electronic S2* (LSI)* & Energy Metering Protection Unit

- Range: 40A – 1600A, **Ics=100%Icu**, Three Optimum Frames
- **Protection against overloads:**
 - Ir adjustable from 0.4 to 1 x In
 - tr adjustable from 3 to 30s#
- **Protection against short circuits:**
 - I_{sd} adjustable from 1.5 to 10 x Ir
 - t_{sd} adjustable from 0 to 0.5s
- **Inbuilt Instantaneous Protection:**
 - Ii# – Fixed
- **Option for In built or add on module for Earth Leakage Protection##**
 - Adjustable sensitivity: 0.03 - 0.3 - 1 - 3 A
 - Adjustable tripping: 0 - 0.3 - 1 - 3s
- Breaking Capacity# – 25kA, 36kA, 50kA, 70kA & 100kA
- Integrated energy metering with accuracy class 2
- Measure for currents, voltage, frequency, power, energy and harmonics
- Internal Battery with battery measure function
- Communication Ready via COMM Port
- Logical Selectivity Ready (Zone Selective Interlocking)
- Dynamic Selectivity as per Selectivity Charts
- In Built USB Port for Software Diagnosis
- Suitable for Isolation



Category	Type	Rated Current (A)	3P			4P		
			Cat.No	MRP*/ ₹ /Unit	Pack	Cat.No	MRP*/ ₹ /Unit	Pack

Electronic S2 + Energy metering

25 KA	DPX ³ 250	40	4204 02	■	1	4204 12	■	1
		100	4204 05	■	1	4204 15	■	1
		160	4204 07	■	1	4204 17	■	1
		250	4204 09	■	1	4204 19	■	1
36 KA	DPX ³ 250	40	4204 32	■	1	4204 42	■	1
		100	4204 35	■	1	4204 45	■	1
		160	4204 37	■	1	4204 47	■	1
		250	4204 39	■	1	4204 49	■	1
	DPX ³ 630	320	4220 97	■	1	4221 02	■	1
		400	4220 98	■	1	4221 03	■	1
		500	4220 99	■	1	4221 04	■	1
		630	4221 00	■	1	4221 05	■	1
		800	4223 48	■	1	4223 54	■	1
		1000	4223 49	■	1	4223 55	■	1
DPX ³ 1600	1250	4223 50	■	1	4223 56	■	1	
	1600	4223 51	■	1	4223 57	■	1	
	DPX ³ 250	40	4204 62	■	1	4204 72	■	1
		100	4204 65	■	1	4204 75	■	1
		160	4204 67	■	1	4204 77	■	1
		250	4204 69	■	1	4204 79	■	1
DPX ³ 630	320	4221 07	■	1	4221 12	■	1	
	400	4221 08	■	1	4221 13	■	1	
	500	4221 09	■	1	4221 14	■	1	
	630	4221 10	■	1	4221 15	■	1	
	800	4223 60	■	1	4223 66	■	1	
	1000	4223 61	■	1	4223 67	■	1	
DPX ³ 1600	1250	4223 62	■	1	4223 68	■	1	
	1600	4223 63	■	1	4223 69	■	1	
	DPX ³ 250	40	4206 65	■	1	4206 75	■	1
		100	4206 67	■	1	4206 77	■	1
		160	4206 68	■	1	4206 78	■	1
		250	4206 69	■	1	4206 79	■	1
DPX ³ 630	320	4221 17	■	1	4221 22	■	1	
	400	4221 18	■	1	4221 23	■	1	
	500	4221 19	■	1	4221 24	■	1	
	630	4221 20	■	1	4221 25	■	1	
	800	4223 72	■	1	4223 78	■	1	
	1000	4223 73	■	1	4223 79	■	1	
DPX ³ 1600	1250	4223 74	■	1	4223 80	■	1	
	1600	4223 75	■	1	4223 81	■	1	

■ Price available on request.

* MRP - Maximum Retail Price Inclusive of all taxes including GST.

MCCB Prices are without spreaders. For ordering spreaders refer page no. 21

Refer Catalogue for frame wise data

For DPX³ 250 and DPX³ 630 Only

Bold Cat.Nos are products normally available with Legrand (India) Stockists.

Cat.Nos that are not bold - delivery within 4 - 8 weeks from the date of order.

Bold packing quantity is our mandatory packing. Orders to be placed by

Legrand (India) Stockist in multiples of the same.



4223 51



4223 54



4206 79

DPX³ MCCB

DPX³ MCCB with Electronic Sg (LSIg) & Energy Metering Protection Unit

- Range: 250A – 1600A, **Ics=100%Icu**, Two Optimum Frames
- **Protection against Overloads:**
 - Ir adjustable from 0.4 to 1 x In
 - tr adjustable from 3 to 30s
- **Protection against Short Circuits:**
 - I_{sd} adjustable from 1.5 to 10 x Ir
 - t_{sd} adjustable from 0 to 0.5s
- **Inbuilt Instantaneous Protection:**
 - li – Fixed
- **Protection against Ground Fault:**
 - I_g adjustable from 0.2 to 1 In & OFF
 - tg adjustable from 0.1 to 1s
- **Option for add on module for Earth Leakage Protection**
 - Adjustable sensitivity: 0.03 - 0.3 - 1 - 3 A
 - Adjustable tripping: 0 - 0.3 - 1 - 3s
- Breaking Capacity – 36kA, 50kA, 70kA & 100kA
- Integrated energy metering with accuracy class 2
- Measure for currents, voltage, frequency, power, energy and harmonics
- Internal Battery with battery measure function
- Communication Ready via COMM Port
- Logical Selectivity Ready (Zone Selective Interlocking)
- Dynamic Selectivity as per Selectivity Charts
- In Built USB Port for Software Diagnosis
- Switchable Thermal Memory
- Suitable for Isolation



Category	Type	Rated Current (A)	3P			4P		
			Cat.No	MRP*/ ₹ /Unit	Pack	Cat.No	MRP*/ ₹ /Unit	Pack

Electronic Sg + Energy metering

36 KA	DPX ³ 630	320	4221 77	■	1	4221 82	■	1
		400	4221 78	■	1	4221 83	■	1
		500	4221 79	■	1	4221 84	■	1
		630	4221 80	■	1	4221 85	■	1
	DPX ³ 1600	800	4224 44	■	1	4224 50	■	1
		1000	4224 45	■	1	4224 51	■	1
		1250	4224 46	■	1	4224 52	■	1
		1600	4224 47	■	1	4224 53	■	1
50 KA	DPX ³ 630	320	4221 87	■	1	4221 92	■	1
		400	4221 88	■	1	4221 93	■	1
		500	4221 89	■	1	4221 94	■	1
		630	4221 90	■	1	4221 95	■	1
	DPX ³ 1600	800	4224 56	■	1	4224 62	■	1
		1000	4224 57	■	1	4224 63	■	1
		1250	4224 58	■	1	4224 64	■	1
		1600	4224 59	■	1	4224 65	■	1
70 KA	DPX ³ 630	320	4221 97	■	1	4222 02	■	1
		400	4221 98	■	1	4222 03	■	1
		500	4221 99	■	1	4222 04	■	1
		630	4222 00	■	1	4222 05	■	1
	DPX ³ 1600	800	4224 68	■	1	4224 74	■	1
		1000	4224 69	■	1	4224 75	■	1
		1250	4224 70	■	1	4224 76	■	1
		1600	4224 71	■	1	4224 77	■	1

Switch disconnector

	DPX ³ 160	160	4201 98	■	1	4201 99	■	1
	DPX ³ 250	250	4202 99	■	1	4203 00	■	1
	DPX ³ 630	400	4222 16	■	1	4222 18	■	1
		630	4222 17	■	1	4222 19	■	1

■ Price available on request.

* MRP - Maximum Retail Price Inclusive of all taxes including GST.

MCCB Prices are without spreaders. For ordering spreaders refer page no. 21

Bold Cat.Nos are products normally available with Legrand (India) Stockists. Cat.Nos that are not bold - delivery within 4 - 8 weeks from the date of order. **Bold packing quantity** is our mandatory packing. Orders to be placed by Legrand (India) Stockist in multiples of the same.

DPX³ MCCB

Category	Type	Rated Current (A)	3P			4P		
			Cat.No	MRP*/₹ /Unit	Pack	Cat.No	MRP*/₹ /Unit	Pack

Only magnetic

16 KA	DPX ³ 160	16	4207 10	11460	1	-	-	-
		25	4207 11	11460	1	-	-	-
		50	4207 12	11460	1	-	-	-
		63	4207 13	11460	1	-	-	-
25 KA	DPX ³ 160	16	4207 14	12734	1	-	-	-
		25	4207 15	12734	1	-	-	-
		50	4207 16	12734	1	-	-	-
		63	4207 17	12734	1	-	-	-
	DPX ³ 250	100	4207 22	20368	1	-	-	-
		160	4207 23	20368	1	-	-	-
		200	4207 24	21644	1	-	-	-
36 KA	DPX ³ 250	250	4207 25	22916	1	-	-	-
		100	4207 18	22240	1	-	-	-
		160	4207 19	22240	1	-	-	-
		200	4207 20	23516	1	-	-	-
		250	4207 21	24786	1	-	-	-

Accessories

Type	Rotary handle				Shunt release											
	Direct		Vary depth		12 V		24 V		48 V		110 V		230 V		400 V	
	Cat.No	MRP	Cat.No	MRP	Cat.No	MRP	Cat.No	MRP	Cat.No	MRP	Cat.No	MRP	Cat.No	MRP	Cat.No	MRP
DPX ³ 160 DPX ³ 250	4201 60	1534	4201 61	2222	4210 12	2532	4210 13	2532	4210 14	2532	4210 15	2532	4210 16	2532	4210 17	2532
DPX ³ 630	4201 62	2454	4201 63	4220	-	-	4222 39	2426	4222 40	2426	4222 41	2426	4222 42	2426	4222 43	2426
DPX ³ 1600	0262 61	3352	0262 83	6244	-	-	-	-	-	-	-	-	-	-	-	-

Type	U/V release													
	12 V		24 V		48 V		110 V		230 V		400 V		480 V	
	Cat.No	MRP	Cat.No	MRP	Cat.No	MRP	Cat.No	MRP	Cat.No	MRP	Cat.No	MRP	Cat.No	MRP
DPX ³ 160 DPX ³ 250	4210 18	2878	4210 19	2878	4210 20	2878	4210 21	2850	4210 22	2850	4210 24	2850	4210 25	2850
DPX ³ 630 DPX ³ 1600	-	-	4222 45	2866	4222 46	2866	4222 47	2840	4222 48	2840	4222 49	2840	-	-

Type	Rated Current (A)	Spreaders**				Motor Operator									
		3P (Set of 3)		4P (Set of 4)		24-230V Side		24V		48V		110V		230V	
		Cat.No	MRP	Cat.No	MRP	Cat.No	MRP	Cat.No	MRP	Cat.No	MRP	Cat.No	MRP	Cat.No	MRP
DPX ³ 160		6250 02	378	6250 06	572										
DPX ³ 250		6250 14	678	6250 18	1010	4210 60	27216	4210 61	24448	4210 61	24448	4210 61	24448	4210 61	24448
DPX ³ 630		6250 04	2624	6250 08	3564	-	-	0261 40	40172	0261 41	40172	-	-	0261 44	40172
DPX ³ 1600	Upto 1250 A	4226 24	■	4226 25	■	-	-	0261 24	78930	0261 25	89416	0261 26	■	0261 23	66052
	Above 1600 A	0262 73	■	0262 74	■	-	-	0261 19	79760	0261 28	68756	0261 29	■	0261 27	66684

■ Price available on request.

* MRP - Maximum Retail Price Inclusive of all taxes including GST.

MCCB Prices are without spreaders. For ordering spreaders refer above table

** Table for Spreaders.

Bold Cat.Nos are products normally available with Legrand (India) Stockists.

Cat.Nos that are not bold - delivery within 4 - 8 weeks from the date of order.

Bold packing quantity is our mandatory packing. Orders to be placed by

Legrand (India) Stockist in multiples of the same.



4210 16



4210 22

DPX³ 160 equipment and mounting accessories

Cat.Nos	Description	MRP* ₹ / Unit	Pack
Equipment for plug-in version			
4210 40	For DPX ³ 160 - 3P	■	1
4210 41	For DPX ³ 160 - 4P with or without earth leakage module	■	1
4210 44	Set of connectors for auxiliary contacts	■	1
4210 45	Key barrel and flat key for Padlocks	■	1
4210 46	Key barrel and star key for Padlocks	■	1
4210 47	Padlock accessory	■	1
Connection accessories			
4210 26	Set of 3 terminals for High capacity cage terminals	6212	1
4210 27	Set of 4 terminals for High capacity cage terminals	8210	1
4210 70	Set of 3 insulated shields	136	1
4210 28	Set of 3 terminals Screw terminals for copper bars connection	704	1
4210 29	Set of 4 terminals Screw terminals for copper bars connection	844	1
6250 02	Set of 3 spreaders for DPX ³ 160 3P	378	1
6250 06	Set of 4 spreaders for DPX ³ 160 4P	572	1



4210 40



4210 36

DPX³ 160 equipment and mounting accessories

Cat.Nos	Description	MRP* ₹ / Unit	Pack
Connection accessories			
4210 36	Set of 3 rear terminals for DPX ³ 160 3P	5812	1
4210 37	Set of 4 rear terminals for DPX ³ 160 4P	7798	1
Sealable terminal shields			
For front terminals			
4210 54	For DPX ³ 160 3P	6348	1
4210 55	For DPX ³ 160 3P	6704	1
For rear terminals			
4210 50	For DPX ³ 160 3P	4012	1
4210 51	For DPX ³ 160 4P	3568	1
Fixing plates			
4210 71	For DPX ³ 160 3P / 4P without earth leakage module	322	1
4210 73	For DPX ³ 160 4P with earth leakage module	812	1
4210 68	For DPX ³ 160 3P / 4P with side mounting motor operator	1478	1

DPX³ 160 and 250 common auxiliaries and accessories

Supply inverter type

4210 58	For fixed version	5358	1
4210 59	For plug-in and draw-out version	5710	1



4210 58

Rotary handles

4201 60	Standard handle for thermal magnetic DPX ³	1534	1
4201 61	Vari-depth standard handles	2222	1
4201 67	Key Lock for VD RH DPX ³ 160 & 250	2792	1
4201 65	Key Lock for DIR RH Type A DPX ³ 160 & 250	2792	1
4201 68	Key Lock for VD RH Type A DPX ³ 160 & 250	2792	1
4201 66	Key Lock for DIR RH Type B DPX ³ 160 & 250	2792	1
4201 69	Key Lock for VD RH Type B DPX ³ 160 & 250	2792	1

Motor-driven handles

4210 60	Side motor operator	27216	1
4210 61	Front motor operator	24448	1
4210 62	Ronis key barrel for front motor operator	■	1
4210 63	Profalux key barrel for front motor operator	■	1

SURGE PROTECTIVE DEVICES

Solutions for all installations and risk levels



Clear, easily identifiable marking for easier maintenance, design in line with other Legrand modular equipment, well thought features: the new SPDs integrate perfectly in the modular rows of Legrand distribution boards.

■ Price available on request.

* MRP - Maximum Retail Price Inclusive of all taxes including GST.

MCCB Prices are without spreaders. For ordering spreaders refer page no. 21

Bold Cat.Nos are products normally available with Legrand (India) Stockists. Cat.Nos that are not bold - delivery within 4 - 8 weeks from the date of order. Bold packing quantity is our mandatory packing. Orders to be placed by Legrand (India) Stockist in multiples of the same.

DPX³ 160 and 250 common auxiliaries and accessories

Cat.Nos	Description	MRP* ₹ / Unit	Pack
---------	-------------	------------------	------

Motor-driven handles

4210 64	Padlock for front motor operator	3314	1
4210 65	Ronis key barrel for side motor operator	25782	1
4210 66	Profalux key barrel for side motor operator	23428	1
4210 67	Padlock for side motor operator	3520	1

Auxiliary contacts

4210 10	1 N/C + 1 N/O auxiliary contact for rotary handles	1370	1
4210 11	Auxiliary contact or fault signalling contact	1070	1
4210 48	Signalling contact plugged-in/drawn-out (for DPX ³ plug-in version)	■	1

Locking accessory

4210 49	Padlock for locking in "open" position	1668	1
---------	--	------	---

Communication interface

4210 75	Modbus	20662	1
---------	--------	-------	---

DPX³ 250 equipment and mounting accessories

Equipment for plug-in version

4210 42	For DPX ³ 250 - 3P	■	1
4210 43	For DPX ³ 250 - 4P with or without earth leakage module	■	1
4210 44	Set of connectors for auxiliary contacts	■	1
4210 45	Key barrel and flat key N° ABA90GEL6149 for Padlocks	■	1
4210 46	Key barrel and star key N° HBA90GPS6149 for Padlocks	■	1
4210 47	Padlock accessory	■	1

Connection accessories

4210 30	Set of 3 cage terminals	2504	1
4210 31	Set of 4 cage terminals	3260	1
4210 70	Set of 3 phase barriers	136	1

■ Price available on request.

* MRP - Maximum Retail Price Inclusive of all taxes including GST.

DPX³ MCCB

Rotary handles for DPX³



- Smaller dimension of rotary handle base for better visibility of parameters and better access to trip unit
- Easy installation
- Spring for better play
- Door defeat mechanism for easy maintenance
- ON / OFF indication on the knob
- Pad Locking on the knob – upto 3 Locks

Bold Cat.Nos are products normally available with Legrand (India) Stockists. Cat.Nos that are not bold - delivery within 4 - 8 weeks from the date of order. Bold packing quantity is our mandatory packing. Orders to be placed by Legrand (India) Stockist in multiples of the same.

DPX³ 250

equipment and mounting accessories

Cat.Nos	Description	MRP* ₹ / Unit	Pack
---------	-------------	------------------	------

Connection accessories

6250 14	Set of 3 spreaders for DPX ³ 250 3P	676	1
6250 18	Set of 4 spreaders for DPX ³ 250 4P	1010	1
4210 38	Set of 3 rear terminals for DPX ³ 250 3P	5872	1
4210 39	Set of 4 rear terminals for DPX ³ 250 4P	7908	1

Sealable terminal shields

For front terminals

4210 56	For DPX ³ 250 3P	6574	1
4210 57	For DPX ³ 250 4P	6960	1

For rear terminals

4210 52	For DPX ³ 250 3P	3922	1
4210 53	For DPX ³ 250 4P	4312	1

Fixing plates

4210 72	For DPX ³ 250 3P / 4P without earth leakage module	330	1
4210 74	For DPX ³ 250 4P with earth leakage module	1402	1
4210 69	For DPX ³ 250 3P / 4P with side mounting motor operator	1452	1



4210 72

DPX³ 630

equipment and accessories

Plug-in version

4222 20	Set of incoming and outgoing terminals - 3P (6 terminals for 3P DPX ³ or 8 terminals for 4P DPX ³)	■	1
4222 21	Set of incoming and outgoing terminals - 4P (6 terminals for 3P DPX ³ or 8 terminals for 4P DPX ³)	■	1
4222 22	Front terminal mounting base for DPX ³ only - 3P	■	1
4222 24	Flat rear terminal mounting base for DPX ³ only - 3P	■	1
4222 23	Front terminal mounting base for DPX ³ only - 4P	■	1
4222 25	Flat rear terminal mounting base for DPX ³ only - 4P	■	1
4222 26	Front terminal mounting base for DPX ³ with earth leakage module - 4 P	■	1
4222 27	Flat rear terminal mounting base for DPX ³ with earth leakage module - 4P	■	1
4222 37	For fixing the signalling contact - 4P Cat.No 0265 74 on a DPX ³ plug-in version	■	1
4222 28	Set of 2 extractor handle	■	1
4222 29	Set of connectors (24-pin)	■	1

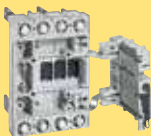

4222 25

■ Price available on request.

* MRP - Maximum Retail Price Inclusive of all taxes including GST.

DPX³ 630

equipment and accessories

Cat.Nos	Description	MRP* ₹ / Unit	Pack
---------	-------------	------------------	------

Draw-out version

4222 31	"Debro-lift" mechanism for DPX ³ base only - 3P	■	1
4222 32	"Debro-lift" mechanism for DPX ³ base only - 4P	■	1
4222 33	"Debro-lift" mechanism for DPX ³ base with elm - 4P	■	1
0265 76	One key for "Debro-lift" mechanism for DPX ³ only - Flat key	■	1
0265 78	Two keys (one key supplied) for "Debro-lift" mechanism for motorised DPX ³ or with rotary handle - Flat key	■	1
0263 48	One key for "Debro-lift" mechanism for DPX ³ only - Star key	■	1
0265 77	Two keys (one key supplied) for motorised DPX ³ or with rotary handle - Star key	■	1
0265 75	Handle for drawing-out for "Debro-lift" mechanism	■	1
0265 74	Signalling contact (plugged-in/drawn-out) for "Debro-lift" mechanism	■	1
4222 36	For fixing the signalling contact Cat.No 0265 74 on a DPX ³ draw-out version	■	1
4222 30	Block of 6 automatic auxiliary contacts for DPX ³ draw-out version (up to 2 blocks by DPX ³)	■	1



4222 32

Supply inverter type

0264 09	Plate for MCCB or trip-free switch fixed version	8062	1
0264 04	Plate for MCCB or trip-free switch plug-in and draw-out version	16710	1

Rotary handles

4201 62	Direct rotary handle	2454	1
4201 63	Vari-depth rotary handle	4220	1
4201 70	Key Lock for VD RH DPX3 630	2792	1
4201 71	Key Lock for VD RH Type A DPX ³ 630	2792	1
4201 72	Key Lock for VD RH Type B DPX ³ 630	2792	1

Motor-driven handles

0261 40	Front operated 24 V~	40172	1
0261 41	Front operated 48 V~	40172	1
0261 44	Front operated 230 V~	40172	1
0261 59	Lock and flat key	13542	1
0261 58	Lock and star key	13920	1



0261 40

Accessories

0262 30	Set of 3 Insulated shields	170	1
0262 44	Set of 2 sealable terminal shields - 3P	4912	1
0262 45	Set of 2 sealable terminal shields - 4P	4972	1

Bold Cat.Nos are products normally available with Legrand (India) Stockists. Cat.Nos that are not bold - delivery within 4 - 8 weeks from the date of order. Bold packing quantity is our mandatory packing. Orders to be placed by Legrand (India) Stockist in multiples of the same.

DPX³ 630 equipment and accessories

Cat.Nos	Description	MRP* ₹ / Unit	Pack
---------	-------------	------------------	------

Accessories

0262 40	Padlock for locking in "OPEN" position - 4P	1692	1
0262 46	Set of 4 adaptors + insulated shields for lug - 4P	7052	1
0262 47	Set of 4 extended front terminals - 4P	10550	1
6250 04	Set of incoming or outgoing spreaders - 3P	2624	1
6250 08	Set of incoming or outgoing spreaders - 4P	3564	1
0263 50	Set of incoming or outgoing swivel rear terminals - 3P	37034	1
0263 52	Set of incoming or outgoing flat rear terminals - 3P	34088	1
0263 51	Set of incoming or outgoing swivel terminals - 4P	49008	1
0263 53	Set of incoming or outgoing flat terminals - 4P	■	1
4222 34	Set of 2 IP 20 terminal covers - 3P	■	1
4222 35	Set of 2 IP 20 terminal covers - 4P	■	1



6250 04



4222 34



4222 35

DPX³ 1600 equipment and accessories

Draw-out version

4225 86	Front terminals - 3P	■	1
4225 88	Rear terminals - 3P	■	1
4225 87	Front terminals - 4P	■	1
4225 89	Rear terminals - 4P	■	1
4225 93	Debro-lift mechanism For DPX ³ 1600 - 3P	■	1
4225 94	Debro-lift mechanism for DPX ³ 1600 - 4P	■	1
4225 95	For fixing the signalling contact Cat.No 0265 74 on a DPX ³ draw-out version	■	1
0265 76	One key for "Debro-lift" mechanism for DPX ³ only - Flat key	■	1
0265 80	Two key (one key supplied) for motorised DPX ³ or with rotary handle	■	1
0263 48	One key for DPX ³ only - Starkey	■	1
0265 79	Two key (one key supplied) for motorised DPX ³ or with rotary handle	■	1
0265 75	Handle for drawing-out for "Debro-lift" mechanism	■	1
0265 74	Signalling contact (plugged-in/drawn-out)	■	1
4222 30	Block of 6 automatic auxiliary contacts for DPX ³ draw-out version (up to 2 blocks by DPX ³)	■	1



4225 88 + 4225 93

Supply inverter type

0264 10	Plate for MCCBs or trip-free switch fixed version	10192	1
0264 05	Plate for MCCBs or trip-free switch plug-in and draw-out version	22902	1

■ Price available on request.

* MRP - Maximum Retail Price Inclusive of all taxes including GST.

DPX³ 1600 equipment and accessories

Cat.Nos	Description	MRP* ₹ / Unit	Pack
---------	-------------	------------------	------

Rotary handles

0262 61	Standard (black) direct on DPX ³	3352	1
0262 83	Standard (black) vari-depth handle IP 55	6244	1
0262 93	Key barrel and flat key	13542	1
0262 94	Key barrel and star key	10528	1

Motor-driven handles

0261 54	Front operated 230 V~	70544	1
0261 24	Front operated 24 V~/= for In ≤ 1250 A	78930	1
0261 25	Front operated 48 V~/= for In ≤ 1250 A	89416	1

Motor-driven handles

0261 26	Front operated 110 V~/= for In ≤ 1250 A	■	1
0261 23	Front operated 230 V~/= for In ≤ 1250 A	66052	1
0261 19	Front operated 24 V~/= for In = 1600 A	79760	1
0261 28	Front operated 48 V~/= for In = 1600 A	68756	1
0261 29	Front operated 110 V~/= for In = 1600 A	■	1
0261 27	Front operated 230 V~/= for In = 1600 A	66684	1
0261 59	Key and flat key	13542	1
0261 58	Key and star key	13920	1

Accessories

0262 66	Set of 3 insulated shields	324	1
0262 64	Set of 2 sealable terminal shields - 3P	10476	1
0262 65	Set of 2 sealable terminal shields - 4P	7708	1
0262 60	Padlock for locking in "open" position	1958	1
0262 67	Set of 4 extended front short terminals for 630 - 1250 A (2 bars max. per pole)	12718	1
0262 68	Set of 4 extended front Long terminals for 1600 A (3 bars max. per pole)	18742	1
4226 24	Set of incoming or outgoing spreaders for 800 A & 1000 A - 3P	■	1
4226 25	Set of incoming or outgoing spreaders for 800 A & 1000 A - 4P	■	1
0262 73	Set of incoming or outgoing spreaders for 1250 A & 1600 A - 3P	■	1
0262 74	Set of incoming or outgoing spreaders for 1250 A & 1600 A - 4P	■	1
0263 80	Short rear terminals - 3P	■	1
0263 81	Long rear terminals - 3P	■	1
0263 82	Short rear terminals - 4P	■	1
0263 83	Long rear terminals - 4P	■	1
4225 90	Set of 2 IP 20 terminal covers - 3P	1280	1
4225 91	Set of 2 IP 20 terminal covers - 4P	2082	1
4225 92	External neutral - 4P	14138	1



0262 60



0262 67 + 0262 68

Bold Cat.Nos are products normally available with Legrand (India) Stockists. Cat.Nos that are not bold - delivery within 4 - 8 weeks from the date of order. Bold packing quantity is our mandatory packing. Orders to be placed by Legrand (India) Stockist in multiples of the same.

DPX³ 630 and 1600 common auxiliaries

Cat.Nos	Description	MRP* ₹ / Unit	Pack
---------	-------------	------------------	------

Common auxiliaries

4210 11	For signalling the state of the contacts or opening of the MCCB on a fault For DPX ³ /DPX ³ -I Changeover switch 3 A - 240 V~	1070	1
---------	--	------	---

Releases

Allow remote tripping of a DPX³

Time-lag undervoltage releases (800 ms)

Prevent false tripping in the event of power supply microbreaks.

Require a time-lag module connected to the undervoltage release Cat.No 4226 23

0261 90	Time-lag module 230 V~ 3 module	19946	1
0261 91	Time-lag module 400 V~ 3 module	29140	1
4226 23	Undervoltage release for DPX ³ 630 and 1600	■	1

Automation control unit

4226 80	Standard unit	69028	1
4226 82	Advanced unit	75304	1
4226 89*	Communication module	19674	1



4226 82

DPX³ 160, 250, 630 and 1600 power supervision system

Auxiliary power supply for DPX³

4210 83	Input voltage 24 V~/=	■	1
	2 modules		

RS485 Modbus communication interface

4210 75	DPX ³ electronic interface for connecting thermal-magnetic DPX ³ with residual current protection and electronic DPX ³ to an RS485 Modbus	■	1
---------	--	---	---

Modular power supply

0035 67	230 V~ - 27 V= - 0.6 A	■	1
	2 modules		

Communication and supervision

4149 48	Web servers for 32 metering points (meters or multi-function measuring units)	■	1
4149 49	Web servers for an unlimited number of metering points (meters or multi-function measuring units)	■	1

■ Price available on request.

* MRP - Maximum Retail Price Inclusive of all taxes including GST.

♦ For Cat.Nos. and further details please contact th nearest branch.

▼ For communication add 422682 + 422689

DPX³ 160, 250, 630 and 1600 power supervision system

Cat.Nos	Description	MRP* ₹ / Unit	Pack
---------	-------------	------------------	------

Communication and supervision

4149 38	Legrand Software For 32 metering points (supplied on CD)	■	1
4149 39	Legrand Software For an unlimited number of metering points (supplied on CD)	■	1

Panel board display

0261 56	Allows to chek information coming from different protection devices: DX ³ -HP, DPX ³ , DMX ³ or EMDX ³	19300	1
---------	--	-------	---

Residual current relay

0260 88	Residual current relay to clip on module 2 rail □	19286	1
---------	--	-------	---

Coils

0260 92	Coil Ø35 mm	■	1
0260 93	Coil Ø80 mm	■	1
0260 94	Coil Ø110 mm	■	1
0260 95	Coil Ø140 mm	■	1
0260 96	Coil Ø210 mm	■	1
0260 97	Coil Ø150 mm - open	■	1
0260 98	Coil Ø300 mm - open	■	1



0261 56



0260 88



0260 93
coil for use
with relay



0260 98

Residual current relay and coils

Measurement and control of electric equipment

0261 35	Central position	■	1/2
0261 37	Microprocessor interface	■	1/3
0261 36	Interface signaling and control	■	1/2
0261 45	Kit configurator	■	1/4
0466 23	Stabilized power	■	1/20

DPX³ automatic transfer switch

DPX³ ready-to-install ATS kit without MCCBs

6253 80*	Ready to use assembly for DPX ³ 160	240654	1
6253 81*	Ready to use assembly for DPX ³ 160 & DPX ³ 250	236710	1
6253 82*	Ready to use assembly for DPX ³ 250	294810	1
6253 87*	Ready to use assembly for DPX ³ 630	285060	1
6253 93	Kit assembly for ATS for DPX ³ 160	16140	1
6253 94	Kit assembly for ATS for DPX ³ 250	20378	1
6253 95	Kit assembly for ATS for DPX ³ 630	26736	1



6253 93

Bold Cat.Nos are products normally available with Legrand (India) Stockists. Cat.Nos that are not bold - delivery within 4 - 8 weeks from the date of order. Bold packing quantity is our mandatory packing. Orders to be placed by Legrand (India) Stockist in multiples of the same.

Mini contactors CTX³ 6 to 16 A industrial contactors



4170 00



4170 01

Cat.Nos	Max. opt. current AC 3	Control voltage	MRP* ₹ / Unit	Pack
---------	------------------------	-----------------	---------------	------

3 pole mini contactors

With integrated auxiliary contact
Power terminals: screw terminals

6 A - Integrated auxiliary contact 1 NO

4170 00	6 A	24 V~	892	1
4170 01	6 A	24 V=	1338	1
4170 04	6 A	110 V~	892	1
4170 06	6 A	230 V~	892	1
4170 09	6 A	415 V~	892	1

6 A - Integrated auxiliary contact 1 NC

4170 10	6 A	24 V~	892	1
4170 11	6 A	24 V=	1338	1
4170 14	6 A	110 V~	892	1
4170 16	6 A	230 V~	892	1
4170 19	6 A	415 V~	892	1

9 A - Integrated auxiliary contact 1 NO

4170 20	9 A	24 V~	978	1
4170 21	9 A	24 V=	1422	1
4170 24	9 A	110 V~	978	1
4170 26	9 A	230 V~	978	1
4170 29	9 A	415 V~	978	1

9 A - Integrated auxiliary contact 1 NC

4170 30	9 A	24 V~	978	1
4170 31	9 A	24 V=	1422	1
4170 34	9 A	110 V~	978	1
4170 36	9 A	230 V~	978	1
4170 39	9 A	415 V~	978	1

12 A - Integrated auxiliary contact 1 NO

4170 40	12 A	24 V~	1060	1
4170 41	12 A	24 V=	1742	1
4170 44	12 A	110 V~	1060	1
4170 46	12 A	230 V~	1060	1
4170 49	12 A	415 V~	1060	1

12 A - Integrated auxiliary contact 1 NC

4170 50	12 A	24 V~	1060	1
4170 51	12 A	24 V=	1742	1
4170 54	12 A	110 V~	1060	1
4170 56	12 A	230 V~	1060	1
4170 59	12 A	415 V~	1060	1

16 A - Integrated auxiliary contact 1 NO

4170 60	16 A	24 V~	1276	1
4170 61	16 A	24 V=	2018	1
4170 64	16 A	110 V~	1276	1
4170 66	16 A	230 V~	1276	1
4170 69	16 A	415 V~	1276	1

16 A - Integrated auxiliary contact 1 NC

4170 70	16 A	24 V~	1276	1
4170 71	16 A	24 V=	2018	1
4170 74	16 A	110 V~	1276	1
4170 76	16 A	230 V~	1276	1
4170 79	16 A	415 V~	1276	1

4-pole mini contactors

Without integrated auxiliary contact
Power terminals: screw terminals

Cat.Nos	Max. opt. current AC 1	Max. opt. current AC 3	Control voltage	MRP* ₹ / Unit	Pack
---------	------------------------	------------------------	-----------------	---------------	------

20 A

4171 40	20 A	16 A	24 V~	978	1
4171 41	20 A	16 A	24 V=	1594	1
4171 44	20 A	16 A	110 V~	978	1
4171 46	20 A	16 A	230 V~	978	1
4171 49	20 A	16 A	415 V~	978	1

* MRP - Maximum Retail Price Inclusive of all taxes including GST.

Thermal relays and accessories for mini contactors

Cat.Nos	Description	MRP* ₹ / Unit	Pack
---------	-------------	---------------	------

Thermal overload relays for 3 pole mini contactors

Class 10 A - Integrated auxiliary contacts 1 NO + 1 NC

4170 80	0.16 A	1020	1
4170 81	0.25 A	1020	1
4170 82	0.40 A	1020	1
4170 83	0.63 A	1020	1
4170 84	1 A	1020	1
4170 85	1.6 A	1020	1
4170 86	2.5 A	1020	1
4170 87	4 A	1020	1
4170 88	6 A	1020	1
4170 89	8 A	1020	1
4170 90	9 A	1020	1
4170 91	10 A	1020	1
4170 92	13 A	1020	1
4170 93	16 A	1020	1



4170 88

Add on auxiliary blocks for mini contactors

Ith : 10 A

Front mounting

4171 50	1 NO + 1 NC	278	15
4171 51	2 NO	278	15
4171 52	2 NC	278	15
4171 53	4 NO	424	15
4171 54	3 NO + 1 NC	424	15
4171 55	2 NO + 2 NC	424	15
4171 56	1 NO + 3 NC	424	15
4171 57	4 NC	424	15



4171 55

Side mounting

4171 58	1 NO	278	20
4171 59	1 NC	278	20

Interlock Unit

4171 60	Mechanical interlock for mini contactors	444	5
---------	--	-----	---

Spare coils

4171 70	24 V~	532	10
4171 71	24 V=	722	10
4171 74	110 V~	532	10
4171 76	230 V~	532	10
4171 79	415 V~	532	10

3-pole contactors CTX³ 9 A to 100 A industrial contactors

Cat.Nos	Max. opt. current AC 3	Control voltage	MRP* ₹ / Unit	Pack
---------	------------------------	-----------------	---------------	------

CTX³ 22

With integrated auxiliary contacts
Power terminals: screw terminals

9 A - Integrated auxiliary contacts 1 NO + 1 NC

4160 80	9 A	24 V~	922	1
4160 81	9 A	24 V=	1768	1
4160 82	9 A	48 V~	922	1
4160 83	9 A	48 V=	1768	1
4160 84	9 A	110 V~	922	1
4160 86	9 A	230 V~	922	1
4160 88	9 A	380 V~	922	1
4160 89	9 A	415 V~	922	1

Bold Cat.Nos are products normally available with Legrand (India) Stockists. Cat.Nos that are not bold - delivery within 4 - 8 weeks from the date of order. Bold packing quantity is our mandatory packing. Orders to be placed by Legrand (India) Stockist in multiples of the same.

3 pole contactors CTX³ 9 A to 100 A industrial contactors

Cat.Nos	Max. opt. current AC 3	Control voltage	MRP* ₹ / Unit	Pack
---------	------------------------	-----------------	---------------	------

12 A - Integrated auxiliary contacts 1 NO + 1 NC

4160 90	12 A	24 V~	1026	1
4160 91	12 A	24 V=	1910	1
4160 92	12 A	48 V~	1026	1
4160 93	12 A	48 V=	1910	1
4160 94	12 A	110 V~	1026	1
4160 96	12 A	230 V~	1026	1
4160 98	12 A	380 V~	1026	1
4160 99	12 A	415 V~	1026	1



4160 96

18 A - Integrated auxiliary contacts 1 NO + 1 NC

4161 00	18 A	24 V~	1174	1
4161 01	18 A	24 V=	2358	1
4161 02	18 A	48 V~	1174	1
4161 03	18 A	48 V=	2358	1
4161 04	18 A	110 V~	1174	1
4161 06	18 A	230 V~	1174	1
4161 08	18 A	380 V~	1174	1
4161 09	18 A	415 V~	1174	1

22 A - Integrated auxiliary contacts 1 NO + 1 NC

4161 10	22 A	24 V~	1660	1
4161 11	22 A	24 V=	3230	1
4161 12	22 A	48 V~	1660	1
4161 13	22 A	48 V=	3230	1
4161 14	22 A	110 V~	1660	1
4161 16	22 A	230 V~	1660	1
4161 18	22 A	380 V~	1660	1
4161 19	22 A	415 V~	1660	1

CTX³ 40

With integrated auxiliary contacts
Power terminals: screw terminals

32 A - Integrated auxiliary contacts 2 NO + 2 NC

4161 20	32 A	24 V~	3318	1
4161 21	32 A	24 V=	6786	1
4161 22	32 A	48 V~	3318	1
4161 23	32 A	48 V=	6786	1
4161 24	32 A	110 V~	3318	1
4161 26	32 A	230 V~	3318	1
4161 28	32 A	380 V~	3318	1
4161 29	32 A	415 V~	3318	1

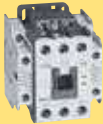

4161 26

40 A - Integrated auxiliary contacts 2 NO + 2 NC

4161 30	40 A	24 V~	5202	1
4161 31	40 A	24 V=	8916	1
4161 32	40 A	48 V~	5202	1
4161 33	40 A	48 V=	8916	1
4161 34	40 A	110 V~	5202	1
4161 36	40 A	230 V~	5202	1
4161 38	40 A	380 V~	5202	1
4161 39	40 A	415 V~	5202	1

CTX³ 65

With integrated auxiliary contacts

50 A - Integrated auxiliary contacts 2 NO + 2 NC
Screw terminals

4161 40	50 A	24 V~	6492	1
4161 41	50 A	24 V=	10986	1
4161 42	50 A	48 V~	6492	1
4161 43	50 A	48 V=	10986	1
4161 44	50 A	110 V~	6492	1
4161 46	50 A	230 V~	6492	1
4161 48	50 A	380 V~	6492	1
4161 49	50 A	415 V~	6492	1



4161 46

* MRP - Maximum Retail Price Inclusive of all taxes including GST.

3 pole contactors CTX³ 9 A to 100 A industrial contactors

Cat.Nos	Max. opt. current AC 3	Control voltage	MRP* ₹ / Unit	Pack
---------	------------------------	-----------------	---------------	------

65 A - Integrated auxiliary contacts 2 NO + 2 NC
Screw terminals

4161 60	65 A	24 V~	8794	1
4161 61	65 A	24 V=	12586	1
4161 62	65 A	48 V~	8794	1
4161 63	65 A	48 V=	12586	1
4161 64	65 A	110 V~	8794	1
4161 66	65 A	230 V~	8794	1
4161 68	65 A	380 V~	8794	1
4161 69	65 A	415 V~	8794	1

3 pole contactors CTX³ 130 A to 800 A industrial contactors

CTX³ 100

With integrated auxiliary contacts

75 A - Integrated auxiliary contacts 2 NO + 2 NC
Screw terminals

4161 80	75 A	24 V~	11356	1
4161 81	75 A	24 V=	15542	1
4161 82	75 A	48 V~	11356	1
4161 83	75 A	48 V=	15542	1
4161 84	75 A	110 V~	11356	1
4161 86	75 A	230 V~	11356	1
4161 88	75 A	380 V~	11356	1
4161 89	75 A	415 V~	11356	1



4161 86

85 A - Integrated auxiliary contacts 2 NO + 2 NC
Screw terminals

4162 00	85 A	24 V~	11412	1
4162 01	85 A	24 V=	15618	1
4162 02	85 A	48 V~	11412	1
4162 03	85 A	48 V=	15618	1
4162 04	85 A	110 V~	11412	1
4162 06	85 A	230 V~	11412	1
4162 08	85 A	380 V~	11412	1
4162 09	85 A	415 V~	11412	1

100 A - Integrated auxiliary contacts 2 NO + 2 NC
Screw terminals

4162 20	100 A	24 V~	14238	1
4162 21	100 A	24 V=	19092	1
4162 22	100 A	48 V~	14238	1
4162 23	100 A	48 V=	19092	1
4162 24	100 A	110 V~	14238	1
4162 26	100 A	230 V~	14238	1
4162 28	100 A	380 V~	14238	1
4162 29	100 A	415 V~	14238	1

CTX³ 150

With integrated auxiliary contacts

130 A - Integrated auxiliary contacts 2 NO + 2 NC
Screw terminals

4162 40	130 A	24 V~	21776	1
4162 41	130 A	24 V=	27734	1
4162 42	130 A	48 V~	21776	1
4162 43	130 A	48 V=	27734	1
4162 46	130 A	100-	21776	1
4162 49	130 A	240 V~/=	21776	1
		400-		
		440 V~		



4162 46

150 A - Integrated auxiliary contacts 2 NO + 2 NC
Screw terminals

4162 60	150 A	24 V~	23450	1
4162 61	150 A	24 V=	28802	1
4162 62	150 A	48 V~	23450	1
4162 63	150 A	48 V=	28802	1
4162 66	150 A	100-	23450	1
4162 69	150 A	240 V~/=	23450	1
		400-		
		440 V~		

Bold Cat.Nos are products normally available with Legrand (India) Stockists. Cat.Nos that are not bold - delivery within 4 - 8 weeks from the date of order. Bold packing quantity is our mandatory packing. Orders to be placed by Legrand (India) Stockist in multiples of the same.

3 pole contactors CTX³ 130 A to 800 A industrial contactors

Cat.Nos	Max. opt. current AC 3	Control Voltage	MRP* ₹ / Unit	Pack
---------	------------------------	-----------------	---------------	------

CTX³ 225

With integrated auxiliary contacts - Screw terminals

185 A - Integrated auxiliary contacts 2 NO + 2 NC

4162 80	185 A	24 V~/=	32918	1
4162 82	185 A	48 V~/=	32918	1
4162 86	185 A	100-240 V~/=	25840	1
4162 89	185 A	380-450 V~	25840	1

225 A - Integrated auxiliary contacts 2 NO + 2 NC

4162 90	225 A	24 V~/=	38976	1
4162 92	225 A	48 V~/=	38976	1
4162 96	225 A	100-240 V~/=	32496	1
4162 99	225 A	380-450 V~	32496	1

CTX³ 400

With integrated auxiliary contacts - Screw terminals

265 A - Integrated auxiliary contacts 2 NO + 2 NC

4163 06	265 A	100-240 V~/=	38010	1
4163 09	265 A	380-450 V~	38010	1

330 A - Integrated auxiliary contacts 2 NO + 2 NC

4163 16	330 A	100-240 V~/=	42096	1
4163 19	330 A	380-450 V~	42096	1

400 A - Integrated auxiliary contacts 2 NO + 2 NC

4163 26	400 A	100-240 V~/=	53854	1
4163 29	400 A	380-450 V~	53854	1

CTX³ 800

With integrated auxiliary contacts - Screw terminals

500 A - Integrated auxiliary contacts 2 NO + 2 NC

4163 36	500 A	200-240 V~/=	72136	1
4163 39	500 A	380-450 V~	72136	1

630 A - Integrated auxiliary contacts 2 NO + 2 NC

4163 46	630 A	200-240 V~/=	97828	1
4163 49	630 A	380-450 V~	97828	1

800 A - Integrated auxiliary contacts 2 NO + 2 NC

4163 56	800 A	200-240 V~/=	156128	1
4163 59	800 A	380-450 V~	156128	1



4162 96



4163 56

Thermal relays RTX³ for CTX³ 3 pole industrial contactors

Cat.Nos	I min. (A)	I max. (A)	MRP* ₹ / Unit	Pack
---------	------------	------------	---------------	------

Thermal overload relays

Class 10A - Integrated auxiliary contacts 1 NO + 1 NC

RTX³ 40 - for CTX³ 22 and 40

Standard type with screw terminals

4166 40	0.1	0.16	1450	1
4166 41	0.16	0.25	1450	1
4166 42	0.25	0.4	1450	1
4166 43	0.4	0.63	1450	1
4166 44	0.63	1	1450	1
4166 45	1	1.6	1450	1
4166 46	1.6	2.5	1450	1
4166 47	2.5	4	1450	1
4166 48	4	6	1450	1
4166 49	5	8	1450	1

RTX³ 40 - for CTX³ 22 and 40

Standard type with screw terminals

4166 50	6	9	1450	1
4166 51	7	10	1450	1
4166 52	9	13	1450	1
4166 53	12	18	1450	1
4166 54	16	22	1478	1
4166 55	18	25	1492	1
4166 56	22	32	1492	1
4166 57	28	40	1606	1

RTX³ 40 - for CTX³ 22 and 40

Differential type with screw terminals

4166 60	0.1	0.16	1720	1
4166 61	0.16	0.25	1720	1
4166 62	0.25	0.4	1720	1
4166 63	0.4	0.63	1736	1
4166 64	0.63	1	1736	1
4166 65	1	1.6	1736	1
4166 66	1.6	2.5	1736	1
4166 67	2.5	4	1736	1
4166 68	4	6	1744	1
4166 69	5	8	1744	1
4166 70	6	9	1744	1
4166 71	7	10	1744	1
4166 72	9	13	1744	1
4166 73	12	18	1744	1
4166 74	16	22	1744	1
4166 75	18	25	1744	1
4166 76	22	32	1754	1
4166 77	28	40	1754	1

RTX³ 65 - for CTX³ 65

Standard type with screw terminals

4166 83	9	13	2912	1
4166 84	12	18	2912	1
4166 85	16	22	2912	1
4166 86	18	25	2912	1
4166 87	24	36	2912	1
4166 88	28	40	2912	1
4166 89	34	50	2912	1
4166 90	45	65	2912	1

RTX³ 100 - for CTX³ 100

Standard type with screw terminals

4167 23	18	25	4546	1
4167 24	24	36	4546	1
4167 25	28	40	4546	1
4167 26	34	50	4546	1
4167 27	45	65	4546	1
4167 28	54	75	4546	1
4167 29	63	85	4546	1
4167 30	70	95	4546	1
4167 31	80	100	4546	1



4167 31

* MRP - Maximum Retail Price Inclusive of all taxes including GST.

Bold Cat.Nos are products normally available with Legrand (India) Stockists. Cat.Nos that are not bold - delivery within 4 - 8 weeks from the date of order. Bold packing quantity is our mandatory packing. Orders to be placed by Legrand (India) Stockist in multiples of the same.

Thermal relays RTX³ for CTX³ 3 pole industrial contactors

Cat.Nos	I min. (A)	I max. (A)	MRP* ₹ / Unit	Pack
---------	---------------	---------------	---------------------	------

RTX³ 150 - for CTX³ 150
Standard type with screw terminals

4167 60	45	65	6280	1
4167 61	54	75	6280	1
4167 62	63	85	6280	1
4167 63	80	105	6280	1
4167 64	95	130	6280	1
4167 65	110	150	6280	1



4167 65

Separate mounting units

To mount the relays separately from contactors, on DIN rail or panel by fixing screws

Cat.Nos	Description	MRP* ₹ / Unit	Pack
---------	-------------	---------------------	------

4165 91	For RTX ³ 40 up to 32 A	560	1
4165 92	For RTX ³ 40 40 A	560	1
4165 93	For RTX ³ 65 with screw terminals	692	1
4165 94	For RTX ³ 65 with cage terminals	692	1
4165 95	For RTX ³ 100 with screw terminals	878	1
4165 96	For RTX ³ 100 with cage terminals	878	1
4165 97	For RTX ³ 150 with screw terminals	1386	1
4165 98	For RTX ³ 150 with cage terminals	1386	1

Thermal overload relays

Class 10 A - Integrated auxiliary contacts 1 NO + 1 NC

Cat.Nos	I min. (A)	I max. (A)	MRP* ₹ / Unit	Pack
---------	---------------	---------------	---------------------	------

RTX³ 225 - for CTX³ 225
Differential type with screw terminals

4167 80	65	100	9182	1
4167 81	85	125	9182	1
4167 82	100	160	9182	1
4167 83	120	185	9182	1
4167 84	160	240	9182	1



4167 84

RTX³ 400 - for CTX³ 400
Differential type with screw terminals

4167 86	85	125	13116	1
4167 87	100	160	13116	1
4167 88	120	185	13116	1
4167 89	160	240	13116	1
4167 90	200	330	13116	1
4167 91	260	400	13116	1

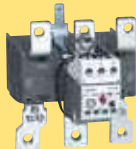

4167 91

RTX³ 800 - for CTX³ 800
Differential type with screw terminals

4167 92	200	300	15300	1
4167 93	260	400	15300	1
4167 94	400	630	15300	1
4167 95	520	800	15300	1

* MRP - Maximum Retail Price Inclusive of all taxes including GST.

4-pole contactors CTX³ 40A to 900A industrial contactors and spare coils

Cat.Nos	Max. opt. current AC-1	Max. opt. current AC-3	Control voltage	MRP* ₹ / Unit	Pack
---------	------------------------	------------------------	-----------------	---------------------	------

Contactors CTX³

Power terminals: screw terminals

Without integrated auxiliary contact

4164 26	40 A	22 A	230 V~	2500	1
4164 36	60 A	40 A	230 V~	6678	1
4164 46	100 A	65 A	230 V~	9794	1
4164 56	135 A	85 A	230 V~	16032	1



4164 36



4164 56



4164 86

With integrated auxiliary contacts

Auxiliary contacts: 2 NO + 2 NC

4164 66	165 A	130 A	100-240 V~/=	19780	1
4164 76	250 A	150 A	100-240 V~/=	25120	1
4164 86	330 A	225 A	100-240 V~/=	33624	1
4164 96	420 A	330 A	100-240 V~/=	45492	1
4165 06	500 A	400 A	100-240 V~/=	48854	1
4165 16	750 A	630 A	200-240 V~/=	101986	1
4165 26	900 A	800 A	200-240 V~/=	122538	1

Spare coils for CTX³ 4P contactors

Cat.Nos	Description	MRP* ₹ / Unit	Pack
---------	-------------	---------------------	------

Control voltage 230 V~

4165 46	For CTX ³ 40 A to 60 A (AC-1)	1250	3
4165 56	For CTX ³ 100 A to 135 A (AC-1)	1250	4
4165 66	For CTX ³ 165 A to 330 A (AC-1)	7810	1
4165 76	For CTX ³ 420 A to 500 A (AC-1)	14578	3
4165 86	For CTX ³ 750 A to 900 A (AC-1)	21866	3

CTX³ accessories

CTX³ add-on auxiliary contact blocks

Front mounting

For CTX³ 3P form 9 A to 150 A (AC-3) and CTX³ 4P from 40 A to 135 A (AC-1) - 2 and 4 pole - lth: 16 A

4168 50	1 NO + 1 NC	354	20
4168 51	2 NO	354	20
4168 52	2 NC	354	20
4168 53	4 NO	562	10
4168 54	3 NO + 1 NC	562	10
4168 55	2 NO + 2 NC	562	10
4168 56	1 NO + 3 NC	562	10
4168 57	4 NC	562	10



4168 50



4168 55

Bold Cat.Nos are products normally available with Legrand (India) Stockists. Cat.Nos that are not bold - delivery within 4 - 8 weeks from the date of order. Bold packing quantity is our mandatory packing. Orders to be placed by Legrand (India) Stockist in multiples of the same.

CTX³ accessories

Cat.Nos	Description	MRP* ₹ / Unit	Pack
---------	-------------	------------------	------

Side mounting

2 pole - Mounting on both sides

4168 58	For CTX ³ 3P Form 9 A to 150 A (AC-3) 1 NO + 1 NC - lth: 16 A	624	20
4168 59	For CTX ³ 3P Form 185 A to 800 A (AC-3) and CTX ³ 4P from 165 A to 900 A (AC-1) 1 NO + 1 NC - lth: 16 A	624	50
4168 49	For CTX ³ 4P Form 40 A to 135 A (AC-1) 1 NO + 1 NC - lth: 16 A	618	60

CTX³ time delay blocks

For CTX³ 3P from 9 A to 150 A (AC-3)

Time delay: 1 to 30 s

Front mounting

On delay

4168 70	24-48 V \sim /=	1718	1
4168 71	110-230 V \sim	1718	1

Off delay

4168 72	24-48 V \sim /=	2358	1
4168 73	110-230 V \sim	2358	1



4168 70

CTX³

capacitor switching units Cat.No 4168 74/75/76/77
Capacitor unit is connected to the terminals of the contactor to reduce the high inrush current.

IEC 60947-4-1 AC 6b

Type	Contactor		Maximum operating power (kVAr)			Max. Peak current (A)
			220 - 240 V	400 - 440 V	500 - 550 V	
4168 74	CTX ³ 22	9 A	5	9.7	14	560
	CTX ³ 22	12 A	6.7	12.5	18	560
	CTX ³ 22	18 A	8.5	16.7	24	850
	CTX ³ 22	22 A	10	18	26	1250
	CTX ³ 40	32 A	15	25	36	1900
	CTX ³ 40	40 A	20	33.3	48	2160
4168 75/76	CTX ³ 65	50 A	20	40	58	2160
	CTX ³ 65	65 A	25	45.7	66	3040
4168 77	CTX ³ 100	75 A	29.7	54	78	3040
	CTX ³ 100	85 A	35	60	92	3040
	CTX ³ 100	100 A	37	62	94	3040

Note:

- When the switch is closed capacitor must be discharged before recharged. (Maximum residual voltage at terminals \leq 50 V)
- To prevent short current, gG type fuse must be 1.5 - 2 times than rated current

* MRP - Maximum Retail Price Inclusive of all taxes including GST.

CTX³ accessories

Cat.Nos	Description	MRP* ₹ / Unit	Pack
---------	-------------	------------------	------

CTX³ capacitor switching units

AC-6b

Operating power from 9.7 kVAr to 62 kVAr (400/440 V)

4168 74	For contactors CTX ³ 3P from 9 to 40 A, upto 33.3 kVAr at 440 V / 48 kVAr at 525 V	1700	1
4168 75	For contactors CTX ³ 3P 50 and 65 A with screw terminals upto 45.7 kVAr at 440 V / 66 kVAr at 525 V	2358	1
4168 76	For contactors CTX ³ 3P 50 and 65 A with cage terminals upto 45.7 kVAr at 440 V / 66 kVAr at 525 V	2550	1
4168 77	For contactors CTX ³ 3P 75 to 100 A with screw terminals upto 62 kVAr at 440 V / 94 kVAr at 525 V	2550	1

CTX³ interlocking

Component parts for assembling by customer
Horizontal mounting

Interlock units

4168 79	Mechanical interlocks for CTX ³ 4P from 40 to 135 A (AC-1)	966	50
---------	---	-----	----



4168 79

Interlock units

4168 80	Mechanical interlocks for CTX ³ 3P from 9 to 150 A Provides 2 NC contacts for use in electrical interlocking	1948	1
4168 87	Mechanical interlocks for CTX ³ 3P from 185 to 400 A and CTX ³ 4P from 165 to 500 A	3504	12

Interlock units

4168 88	Mechanical interlocks for CTX ³ 3P from 500 to 800 A	3826	1
4168 89	Mechanical interlocks for CTX ³ 4P from 750 to 900 A	4038	1

Bold Cat.Nos are products normally available with Legrand (India) Stockists. Cat.Nos that are not bold - delivery within 4 - 8 weeks from the date of order. **Bold packing quantity** is our mandatory packing. Orders to be placed by Legrand (India) Stockist in multiples of the same.

CTX³ accessories

Cat.Nos	Description	MRP* ₹ / Unit	Pack
---------	-------------	------------------	------

Wire kits

Used for making reversing between two 3P contactors

4168 82	For CTX ³ 22	1020	4
4168 83	For CTX ³ 40	1380	6
4168 84	For CTX ³ 65	1700	2
4168 85	For CTX ³ 100	2848	1

Boxes for motor starter

For CTX³ 22 equipped with RTX³ 40 (0.1 - 22 A)

4168 90	Without pushbuttons	2598	1
4168 91	With pushbuttons	3184	1



4168 91

CTX³ transient voltage suppressor blocks

Absorbs the surge arisen out of the coil of the contactor

4168 95	24-48 V V~/=	472	10
4168 96	100-125 V V~/=	472	10
4168 97	200-240 V V~/=	472	10
4168 98	380-400 V V~	472	10



4168 97

CTX³ terminals covers

4168 42	For CTX ³ 3P from 185 to 225 A (AC-3)	440	10
4168 43	For CTX ³ 3P from 265 to 400 A (AC-3)	658	25
4168 44	For CTX ³ 3P from 500 to 900 A (AC-3)	988	5
4168 45	For CTX ³ 4P from 165 to 330 A (AC-1)	550	10
4168 46	For CTX ³ 4P from 420 to 500 A (AC-1)	834	10
4168 47	For CTX ³ 4P from 750 to 900 A (AC-1)	1406	5

CTX³ safety front cover

4168 40	For CTX ³ 3P from 9 to 150 A (AC-3) and CTX ³ 4P from 40 to 135 A (AC-1)	28	150
4168 41	For CTX ³ 3P from 85 to 800 A (AC-3) and CTX ³ 4P from 165 to 900 A (AC-1)	110	150



4168 40

Distant reset flexible cables for thermal relays

4168 92	400 mm	624	1
4168 93	500 mm	630	1
4168 94	600 mm	640	1

* MRP - Maximum Retail Price Inclusive of all taxes including GST.

CTX³ spare coils

Cat.Nos	Description	MRP* ₹ / Unit	Pack
---------	-------------	------------------	------

Spare coils for CTX³ 3P contactors

For CTX³ 22

4169 00	24 V~	570	4
4169 02	48 V~	570	4
4169 04	110 V~	570	4
4169 06	230 V~	570	4
4169 08	380 V~	570	4
4169 09	415 V~	570	4

For CTX³ 40

4169 20	24 V~	570	6
4169 21	24 V=	570	6
4169 22	48 V~	570	6
4169 23	48 V=	570	6
4169 24	110 V~	570	6
4169 26	230 V~	570	6
4169 28	380 V~	570	6
4169 29	415 V~	570	6

For CTX³ 65

4169 30	24 V~	676	4
4169 31	24 V=	676	2
4169 32	48 V~	676	4
4169 33	48 V=	676	2
4169 34	110 V~	676	4
4169 36	230 V~	676	4
4169 38	380 V~	676	4
4169 39	415 V~	676	4

For CTX³ 100

4169 40	24 V~	824	3
4169 41	24 V=	824	2
4169 42	48 V~	824	3
4169 43	48 V=	824	2
4169 44	110 V~	824	3
4169 46	230 V~	824	3
4169 48	380 V~	824	3
4169 49	415 V~	824	3

For CTX³ 150

4169 50	24 V~	4862	2
4169 51	24 V=	4862	2
4169 52	48 V~	4862	2
4169 53	48 V=	4862	2
4169 56	100-240 V V~/=	4862	2
4169 59	400-440 V~	4862	2

For CTX³ 225

4169 60	24 V~/=	5706	1
4169 62	48 V~/=	5706	1
4169 66	100-240 V~/=	5706	1
4169 69	400-440 V~	5706	1

For CTX³ 400

4169 76	100-240 V~/=	10568	3
4169 79	380-450 V~	10568	3

For CTX³ 400

4169 86	200-240 V~/=	16698	3
4169 89	380-450 V~	16698	3



4169 66

Bold Cat.Nos are products normally available with Legrand (India) Stockists. Cat.Nos that are not bold - delivery within 4 - 8 weeks from the date of order. Bold packing quantity is our mandatory packing. Orders to be placed by Legrand (India) Stockist in multiples of the same.

Control relays CTX³

Cat.Nos	Description	MRP* ₹ / Unit	Pack
---------	-------------	------------------	------

CTX³ control relays

4 pole
Conform to IEC 60 947-1, IEC 60 947-4-1 and IEC 60 947-5-1 for the auxiliary contacts
Can be equipped with CTX³ mini lth = 10 A
Low consumption coil

4 NO

4168 00	24 V~	1020	1
4168 01	24 V=	1592	1
4168 02	48 V~	1020	1
4168 03	48 V=	1592	1
4168 04	110 V~	1020	1
4168 06	230 V~	1020	1
4168 09	400 V~	1020	1

3 NO + 1 NC

4168 10	24 V~	1020	1
4168 11	24 V=	1592	1
4168 12	48 V~	1020	1
4168 13	48 V=	1592	1
4168 14	110 V~	1020	1
4168 16	230 V~	1020	1
4168 19	400 V~	1020	1

2 NO + 2 NC

4168 20	24 V~	1020	1
4168 21	24 V=	1592	1
4168 22	48 V~	1020	1
4168 23	48 V=	1592	1
4168 24	110 V~	1020	1
4168 26	230 V~	1020	1
4168 29	400 V~	1020	1

MPCBs MPX³

motor protection circuit breakers from 0.16 A to 100 A

Cat.Nos	Rated 3Ph Motor	Thermal release adj. range (A)	Magnetic release operating current (A)	MRP* ₹ / Unit	Pack
---------	-----------------	--------------------------------	--	------------------	------

Thermal magnetic MPCBs

Adjustable thermal release Magnetic release 13 le max.

MPX³ 32S - 3P

Standard breaking capacity with toggle handle
Fixing on rail

415 V breaking capacity Icu (kA) - 100

4173 00	0.02	0.1 to 0.16	2.1	2928	1
4173 01	0.06	0.16 to 0.25	3.3	2928	1
4173 02	0.09	0.25 to 0.4	5.2	2928	1
4173 03	0.12	0.4 to 0.63	8.2	3404	1
4173 04	0.18 / 0.25	0.63 to 1	13	3404	1
4173 05	0.37 / 0.55	1 to 1.6	20.8	3426	1
4173 06	0.75	1.6 to 2.5	32.5	3426	1
4173 07	1.5	2.5 to 4	52	3546	1
4173 08	2.2	4 to 6	78	3530	1
4173 09	3	5 to 8	104	3530	1

* MRP - Maximum Retail Price Inclusive of all taxes including GST.

MPCBs MPX³

motor protection circuit breakers from 0.16 A to 100 A

Cat.Nos	Rated 3Ph Motor	Thermal release adj. range (A)	Magnetic release operating current (A)	MRP* ₹ / Unit	Pack
---------	-----------------	--------------------------------	--	------------------	------

415 V breaking capacity Icu (kA) - 50

4173 10	4	6 to 10	130	3530	1
4173 11	5.5	9 to 13	169	4002	1

415 V breaking capacity Icu (kA) - 20

4173 12	7.5	11 to 17	221	4312	1
---------	-----	----------	-----	------	---

415 V breaking capacity Icu (kA) - 15

4173 13	7.5	14 to 22	286	4926	1
4173 14	11	18 to 26	338	4926	1
4173 15	15	22 to 32	416	8110	1

MPX³ 32H - 3P

High breaking capacity with rotary handle

Fixing on rail

415 V breaking capacity Icu (kA) - 100

4173 20	0.02	0.1 to 0.16	2.1	3650	1
4173 21	0.06	0.16 to 0.25	3.3	3650	1
4173 22	0.09	0.25 to 0.4	5.2	3650	1
4173 23	0.12	0.4 to 0.63	8.2	4002	1
4173 24	0.18 / 0.25	0.63 to 1	13	4002	1
4173 25	0.37 / 0.55	1 to 1.6	20.8	4002	1
4173 26	0.75	1.6 to 2.5	32.5	4002	1
4173 27	1.5	2.5 to 4	52	4126	1
4173 28	2.2	4 to 6	78	4106	1
4173 29	3	5 to 8	104	4394	1
4173 30	4	6 to 10	130	4394	1
4173 31	5.5	9 to 13	169	4968	1

415 V breaking capacity Icu (kA) - 50

4173 32	7.5	11 to 17	221	6160	1
4173 33	7.5	14 to 22	286	6160	1
4173 34	11	18 to 26	338	6160	1
4173 35	15	22 to 32	416	9650	1

MPX³ 63H - 3P

High breaking capacity with rotary handle

Fixing on rail or by screw

415 V breaking capacity Icu (kA) - 100

4173 60	4	6 to 10	130	9370	1
4173 61	5.5	9 to 13	169	9370	1

415 V breaking capacity Icu (kA) - 50

4173 62	7.5	11 to 17	221	9370	1
4173 63	7.5	14 to 22	286	10620	1
4173 64	11	18 to 26	338	10620	1
4173 65	15	22 to 32	416	10620	1
4173 66	18.5	28 to 40	520	11870	1
4173 67	22	34 to 50	650	14578	1
4173 68	30	45 to 63	819	15408	1

MPX³ 100H - 3P

High breaking capacity with rotary handle

Fixing on rail or by screw

415 V breaking capacity Icu (kA) - 100

4173 70	7.5	11 to 17	221	12952	1
4173 71	7.5	14 to 22	286	12952	1
4173 72	11	18 to 26	338	12952	1
4173 73	15	22 to 32	416	12952	1
4173 74	18.5	28 to 40	520	12952	1
4173 75	22	34 to 50	650	15394	1
4173 76	30	45 to 63	819	16136	1

Bold Cat.Nos are products normally available with Legrand (India) Stockists. Cat.Nos that are not bold - delivery within 4 - 8 weeks from the date of order. Bold packing quantity is our mandatory packing. Orders to be placed by Legrand (India) Stockist in multiples of the same.



4168 10



4173 68



4173 08

MPCBs MPX³

motor protection circuit breakers from 0.16 A to 100 A



4173 79

Cat.Nos	Rated 3Ph Motor	Thermal release adj. range (A)	Magnetic release operating current (A)	MRP* ₹ / Unit	Pack
415 V breaking capacity Icu (kA) - 75					
4173 77	37	55 to 75	975	17350	1
4173 78	45	70 to 90	1170	17350	1
4173 79	45	80 to 100	1300	17350	1

Magnetic only MPCBs

Without thermal release
Magnetic release 13 x Ie max.

Cat.Nos	Rated 3Ph Motor	Magnetic release operating current (A)	MRP* ₹ / Unit	Pack
4173 40	0.02	2.1	3314	1
4173 41	0.06	3.3	3314	1
4173 42	0.09	5.2	3314	1
4173 43	0.12	8.2	3690	1
4173 44	0.18 / 0.25	13	3690	1
4173 45	0.37 / 0.55	20.8	3690	1
4173 46	0.75	32.5	3690	1
4173 47	1.5	52	3732	1
4173 48	2.2	78	3732	1
4173 49	3	104	3732	1
4173 50	4	130	3940	1
4173 51	5.5	169	4186	1

MPX³ 32MA - 3P

High breaking capacity with rotary handle
Fixing on rail

415 V breaking capacity Icu (kA) - 100

4173 40	0.02	2.1	3314	1
4173 41	0.06	3.3	3314	1
4173 42	0.09	5.2	3314	1
4173 43	0.12	8.2	3690	1
4173 44	0.18 / 0.25	13	3690	1
4173 45	0.37 / 0.55	20.8	3690	1
4173 46	0.75	32.5	3690	1
4173 47	1.5	52	3732	1
4173 48	2.2	78	3732	1
4173 49	3	104	3732	1
4173 50	4	130	3940	1
4173 51	5.5	169	4186	1



4173 48

415 V breaking capacity Icu (kA) - 50

4173 52	7.5	221	5388	1
4173 53	7.5	286	5388	1
4173 54	11	338	5388	1
4173 55	15	416	8912	1

MPCBs MPX³ accessories

Cat.Nos	Description	MRP* ₹ / Unit	Pack
4174 00	1 NO + 1 NC	708	2
4174 01	2 NO	708	2
4174 02	2 NC	708	2

Auxiliary contacts

2 pole

Side mounting

Mounting on the left side of MPCBs
Two auxiliary contacts per MPCB

4174 00	1 NO + 1 NC	708	2
4174 01	2 NO	708	2
4174 02	2 NC	708	2

4174 00

Front mounting

One auxiliary contact per MPCB

4174 03	1 NO + 1 NC	730	10
4174 04	2 NO	730	10
4174 05	2 NC	730	10



4174 03

Alarm contacts

1 NO + 1 NC

Any trip alarm contact

Operates in case of trip
Mounting on the left side of MPCBs
Set alarm contact first in case of using auxiliary contact together (MPX³ 63H can not accept auxiliary contact and alarm contact together)

4174 06	For MPX ³ 32	1144	1
4174 08	For MPX ³ 63 and 100	1144	1

* MRP - Maximum Retail Price Inclusive of all taxes including GST.

MPCBs MPX³ accessories

Cat.Nos	Description	MRP* ₹ / Unit	Pack
4174 07	1 NO + 1 NC	1144	2

Magnetic trip alarm contact

Operates in case of instantaneous trip

Mounting on the left side of MPCBs

Set alarm contact first in case of using auxiliary contact together

4174 07	1 NO + 1 NC	1144	2
---------	-------------	------	---

Shunt release

Mounting on the right side of MPCBs

One release per MPCB

4174 10	24 V - 50 Hz / 28 V - 60 Hz	1818	1
4174 11	110 V - 50 Hz / 120 V - 60 Hz	1818	1
4174 12	220-230 V - 50 Hz / 240-260 V - 60 Hz	1818	1
4174 13	380-400 V - 50 Hz / 440-460 V - 60 Hz	1818	1



4174 12

Undervoltage release

Mounting on the right side of MPCBs

One release per MPCB

Without auxiliary contact

4174 20	24 V - 50 Hz / 28 V - 60 Hz	1818	1
4174 21	110 V - 50 Hz / 120 V - 60 Hz	1818	1
4174 22	220-230 V - 50 Hz / 240-260 V - 60 Hz	1818	1
4174 23	380-400 V - 50 Hz / 440-460 V - 60 Hz	1818	1



4174 22

With 2 NO auxiliary contacts

Can not attach to MPX³ 32S

4174 30	24 V - 50 Hz / 28 V - 60 Hz	2426	1
4174 31	110 V - 50 Hz / 120 V - 60 Hz	2426	1
4174 32	220-230 V - 50 Hz / 240-260 V - 60 Hz	2426	1
4174 33	380-400 V - 50 Hz / 440-460 V - 60 Hz	2426	1

Dial Cover

Sealable cover to protect the set value from the operation that is not intended

Without auxiliary contact

4174 79	For all types of MPX ³	86	100
---------	-----------------------------------	----	-----

Direct adaptor and mounting unit

For mounting CTX³ contactors under MPX³ MPCBs

Direct adaptators

Used to connect MPX³ directly with the contactor

4174 40	For MPX ³ 32S with CTX ³ mini AC	424	2
4174 41	For MPX ³ 32S with CTX ³ mini DC	424	2
4174 42	For MPX ³ 32H/32MA with CTX ³ mini AC	424	2
4174 43	For MPX ³ 32H/32MA with CTX ³ mini DC	424	2
4174 48	For MPX ³ 32S with CTX ³ 22 AC	510	2
4174 49	For MPX ³ 32S with CTX ³ 22 DC	510	2
4174 50	For MPX ³ 32H/32MA with CTX ³ 22 AC	510	2



4174 50

Bold Cat.Nos are products normally available with Legrand (India) Stockists. Cat.Nos that are not bold - delivery within 4 - 8 weeks from the date of order. Bold packing quantity is our mandatory packing. Orders to be placed by Legrand (India) Stockist in multiples of the same.

XL³ enclosure for safety and flexibility

Protection & distribution up to 6300 A



- Totally type-tested system as per IEC 61439-1 & 2
- Completely bolted system for ease of assembly
- Modular design for numerous configurations
- Short time current withstand capacity upto 110 kA
- Design suitable for Form 4b
- IP 55 and IP 43
- Fire resistance of 750 °C for 30 sec
- Compatible with Zucchini busbar trunking system
- Adjustable plinth height for the better spreading of cables
- Permanent earthing for internal components and external faceplates
- Perfectly house the whole range of Legrand ACBs, MCCBs, Capacitors, Contactors, MCBs, Metering devices and OMPs like VSP, MPCB etc.

MPCBs MPX³ accessories

Cat.Nos	Description	MRP* ₹ / Unit	Pack
---------	-------------	------------------	------

Direct adaptators

Used to connect MPX³ directly with the contactor

4174 51	For MPX ³ 32H/32MA with CTX ³ 22 DC	510	2
4174 52	For MPX ³ 32S with CTX ³ 40 AC	616	2
4174 53	For MPX ³ 32S with CTX ³ 40 DC	616	2
4174 54	For MPX ³ 32H/32MA with CTX ³ 40 AC	616	2
4174 55	For MPX ³ 32H/32MA with CTX ³ 40 DC	616	2
4174 56	For MPX ³ 63H with CTX ³ 65 AC with cage type terminals	744	2
4174 57	For MPX ³ 63H with CTX ³ 65 DC with cage type terminals	744	2
4174 58	For MPX ³ 100H with CTX ³ 100 AC with cage type terminals	744	1
4174 59	For MPX ³ 100H with CTX ³ 100 DC with cage type terminals	744	1



4174 56



4174 61



4174 63



4174 73



4174 81

Mounting unit

This device is used for joining together MPX³ MCPBs and CTX³ contactors

4174 60	For MPX ³ 32S/32H/32MA	574	2
4174 61	For MPX ³ 63H	1060	1
4174 62	For MPX ³ 100H	1276	1

Rotary handle

Mounting on panel's door to control the MPX³

4174 63	For MPX ³ 32H and 32 MA	2124	1
4174 64	For MPX ³ 63H	2124	1
4174 65	For MPX ³ 100H	2124	1

Phase busbar

For parallel connection of MPX³

For MPX³ 32S, 32H and 32MA

Rated current 63 A

4174 71	2 devices	596	10
4174 73	3 devices	1488	10
4174 75	4 devices	1488	10
4174 76	5 devices	1488	10
4174 77	Feeder for phase busbar 32 A	416	4

For MPX³ 63H

Rated current 108 A

4174 72	2 devices	1060	4
4174 74	3 devices	1594	4

Enclosures for MPX³ 32H and 32MA

IP 65 enclosure to use in dusty areas as well as in presence of corrosive gas or liquid

4174 80	Yellow/red with rotary handle	1226	1
4174 81	With black rotary handle	1594	1

* MRP - Maximum Retail Price Inclusive of all taxes including GST.
Red Cat.Nos - new products

Alpican™ gas filled capacitors

Cat.Nos	Description	MRP* ₹ / Unit	Pack
---------	-------------	------------------	------

Heavy duty gas filled capacitor 440 V, 3 phase, 50 Hz

4151 24	5.2 kVAr	2380	1/4
4151 25	7.3 kVAr	3310	1/4
4151 26	8.8 kVAr	3914	1/4
4151 27	10.5 kVAr	4764	1/4
4151 28	12.6 kVAr	5604	1/4
4151 29	16.8 kVAr	7860	1/4
4151 30	21 kVAr	9344	1/4
4151 31	25.2 kVAr	11106	1/4



4151 29

NEW! Alpx³

Confirms to IS13340-1&2 , IEC60831-1&2
ISI Mark
Compact Design
Self healing metallized polypropylene film
Over pressure device for disconnection
Low energy losses
Resistance to high temperature
Resin filled

Standard duty can-type 440 V

5150 00	1 kVAr Resin std duty 440 V	229	1/12
5150 01	2 kVAr Resin std duty 440 V	459	1/12
5150 02	3 kVAr Resin std duty 440 V	688	1/12
5150 03	4 kVAr Resin std duty 440 V	917	1/12
5150 04	5 kVAr Resin std duty 440 V	1076	1/12
5150 05	7.5 kVAr Resin std duty 440 V	1614	1/6
5150 06	10 kVAr Resin std duty 440 V	2152	1/4
5150 07	12.5 kVAr Resin std duty 440	2690	1/4
5150 08	15 kVAr Resin std duty 440 V	3228	1/4
5150 09	20 kVAr Resin std duty 440 V	4304	1/4
5150 10	25 kVAr Resin std duty 440 V	5380	1/4
5150 11	30 kVAr Resin std duty 440 V	6674	1/4



5150 04



5150 06

Heavy duty can-type 440 V

5150 12	1 kVAr Resin heavy duty 440 V	425	1/12
5150 13	2 kVAr Resin heavy duty 440 V	850	1/12
5150 14	3 kVAr Resin heavy duty 440 V	1134	1/12
5150 15	4 kVAr Resin heavy duty 440 V	1512	1/12
5150 16	5 kVAr Resin heavy duty 440 V	1793	1/6
5150 17	7.5 kVAr Resin heavy duty 440	2690	1/4
5150 18	10 kVAr Resin heavy duty 440	3587	1/4
5150 19	12.5 kVAr Resin heavy duty 44	4484	1/4

Bold Cat.Nos are products normally available with Legrand (India) Stockists.
Cat.Nos that are not bold - delivery within 4 - 8 weeks from the date of order.
Bold packing quantity is our mandatory packing. Orders to be placed by Legrand (India) Stockist in multiples of the same.

NEW!

Alpx³
Resin filled capacitors



5150 23

Cat.Nos	Description	MRP* ₹ / Unit	Pack
---------	-------------	------------------	------

Heavy duty can-type 440 V

5150 20	15 kVAr Resin heavy duty 440	5380	1/4
5150 21	20 kVAr Resin heavy duty 440	6985	1/4
5150 22	25 kVAr Resin heavy duty 440	8732	1/2
5150 23	30 kVAr Resin heavy duty 440	11537	1/2

Standard duty can-type 480 V

5150 24	4.2 kVAr Resin 480 V	2023	1/6
5150 25	6.9 kVAr Resin 480 V	2791	1/4
5150 26	8.7 kVAr Resin 480 V	4207	1/4
5150 27	10.4 kVAr Resin 480 V	5056	1/4
5150 28	14 kVAr Resin 480 V	5663	1/4
5150 29	17.4 kVAr Resin 480 V	6828	1/4
5150 30	20.8 kVAr Resin 480 V	8687	1/4

Standard duty can-type 525 V

5150 31	5 kVAr Resin 525 V	2204	1/6
5150 32	8.3 kVAr Resin 525 V	3658	1/4
5150 33	10.4 kVAr Resin 525 V	4584	1/4
5150 34	12.5 kVAr Resin 525 V	5509	1/4
5150 35	16.7 kVAr Resin 525 V	7199	1/4
5150 36	20.8 kVAr Resin 525 V	8966	1/4
5150 37	25 kVAr Resin 525 V	10777	1/4

Standard duty box-type 440 V

5150 40	1 kVAr Std box Capacitor 440 V	301	1/4
5150 41	2 kVAr Std box Capacitor 440 V	602	1/4
5150 42	3 kVAr Std box Capacitor 440 V	903	1/4
5150 43	4 kVAr Std box Capacitor 440 V	1204	1/4
5150 44	5 kVAr Std box Capacitor 440 V	1443	1
5150 45	7.5 kVAr Std box Capacitor 440 V	2165	1
5150 46	8.33 kVAr Std box Capacitor 440 V	2396	1
5150 47	10 kVAr Std box Capacitor 440 V	2887	1
5150 48	12.5 kVAr Std box Capacitor 440 V	3609	1
5150 49	15 kVAr Std box Capacitor 440 V	4330	1
5150 50	20 kVAr Std box Capacitor 440 V	5774	1
5150 51	25 kVAr Std box Capacitor 440 V	7217	1
5150 52	50 kVAr Std box Capacitor 440 V	17199	1



5150 47

Heavy duty box-type 440 V

5150 53	5 kVAr HD box capacitor 440 V	2143	1
5150 54	7.5 kVAr HD box capacitor 440 V	3214	1

* MRP - Maximum Retail Price Inclusive of all taxes including GST.
Red Cat.Nos - new products

NEW!

Alpx³
Resin filled capacitors



5150 61

Cat.Nos	Description	MRP* ₹ / Unit	Pack
---------	-------------	------------------	------

Heavy duty box-type 440 V

5150 55	8.33 kVAr HD box capacitor 440 V	3557	1
5150 56	10 kVAr HD box capacitor 440 V	4285	1
5150 57	12.5 kVAr HD box capacitor 440 V	5356	1
5150 58	15 kVAr HD box capacitor 440 V	6428	1
5150 59	20 kVAr HD box capacitor 440 V	8385	1
5150 60	25 kVAr HD box capacitor 440 V	10482	1
5150 61	50 kVAr HD box capacitor 440 V	20963	1

Reactors

Reactors 7 % duty



4151 50

4151 48	Reactor 10 kVAr	13146	1
4151 49	Reactor 12.5 kVAr	17214	1
4151 50	Reactor 25 kVAr	21704	1
4151 51	Reactor 50 kVAr	35300	1
4151 52	Reactor 100 kVAr	70704	1

Reactors 14 % duty

4151 53	Reactor 12.5 kVAr	20266	1
4151 54	Reactor 25 kVAr	33776	1
4151 55	Reactor 50 kVAr	44654	1

Power factor controller Eco

4151 95	4 step controller	13440	1
4151 96	6 step controller	14176	1
4151 97	8 step controller	14716	1
4151 98	12 step controller	17494	1

Warranty

- The Company, at its discretion, will replace products if they have any manufacturing defect within 1 years for capacitor, Reactor & APFC controller.
- The above guarantee is applicable when the products are selected taken into consideration all the technical characteristics of the product published in our catalogue.
- The guarantee is only applicable when the products are installed as per the Company's instructions and not tampered in any manner.
- The guarantee states the Company's entire liability. It does not extend to cover consequential loss or damage or installation costs arising from defective products.

Bold Cat.Nos are products normally available with Legrand (India) Stockists. Cat.Nos that are not bold - delivery within 4 - 8 weeks from the date of order. Bold packing quantity is our mandatory packing. Orders to be placed by Legrand (India) Stockist in multiples of the same.



Sliding shutters



COPYTRACER
Anti-counterfeit registration number



Improved air channels

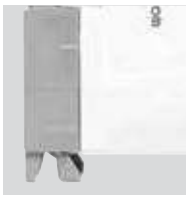

Bottom clamp



Environment friendly



DX³ The Next Step.

Presenting, DX³, an international range of protection devices. Its revolutionary design supports all kind of installations thus giving a never before experience. With 10 patents and 13 new features, it defines the next step in the protection category.

New top clamp
for all tools

Technical
labelling area



Integrated label
holder



Black handle: circuit breakers
Grey handle: switches

Breaking capacity

- 16 kA
- 25 kA
- 36 kA
- 50 kA

Colour coded
handle with
ON/OFF
colour indication



DX³ MCBs

Cat.Nos	Nominal Rating	Number of 17.5 mm modules	MRP* ₹ / Unit	Pack
---------	----------------	---------------------------	---------------	------

MCBs for AC applications till 63 A

10 kA ISI marked as per IS/IEC 60898-1 2002
 Integrated label holder
 Sliding bottom clamp
 Improved air channels
 Color coded On/Off indication on dolly
 Biconnect lower terminals
 IP 20 protected terminals
 Sliding shutters
 DC-80 V per pole - 1 kA

C Curve

Single pole 240/410 V

4085 80	0.5	1	440	1/10/120
4085 81	1	1	440	1/10/120
4085 83	2	1	440	1/10/120
4085 84	3	1	440	1/10/120
4085 85	4	1	440	1/10/120
4085 87	6	1	274	1/10/120
4085 90	10	1	274	1/10/120
4085 92	16	1	274	1/10/120
4085 93	20	1	274	1/10/120
4085 94	25	1	274	1/10/120
4085 95	32	1	274	1/10/120
4085 96	40	1	604	1/10/120
4085 97	50	1	604	1/10/120
4085 98	63	1	604	1/10/120

Single pole + Neutral 240 V

4086 02	0.5	2	1180	1/5/60
4086 03	1	2	1180	1/5/60
4086 05	2	2	1180	1/5/60
4086 06	3	2	1180	1/5/60
4086 07	4	2	1180	1/5/60
4086 09	6	2	818	1/5/60
4086 12	10	2	818	1/5/60
4086 14	16	2	818	1/5/60
4086 15	20	2	818	1/5/60
4086 16	25	2	818	1/5/60
4086 17	32	2	818	1/5/60
4086 18	40	2	1330	1/5/60
4086 19	50	2	1330	1/5/60
4086 20	63	2	1330	1/5/60

Double pole 415 V

4086 21	0.5	2	1172	1/40
4086 22	1	2	1172	1/40
4086 24	2	2	1172	1/40
4086 25	3	2	1172	1/40
4086 26	4	2	1172	1/40
4086 28	6	2	830	1/40
4086 31	10	2	830	1/40
4086 33	16	2	830	1/40
4086 34	20	2	830	1/40
4086 35	25	2	830	1/40
4086 36	32	2	830	1/40
4086 37	40	2	1336	1/40
4086 38	50	2	1336	1/40
4086 39	63	2	1336	1/40

Triple pole 415 V

4086 43	0.5	3	1810	1/32
4086 44	1	3	1810	1/32
4086 46	2	3	1810	1/32
4086 47	3	3	1810	1/32
4086 48	4	3	1810	1/32
4086 50	6	3	1356	1/32
4086 53	10	3	1356	1/32
4086 55	16	3	1356	1/32
4086 56	20	3	1356	1/32
4086 57	25	3	1356	1/32
4086 58	32	3	1356	1/32
4086 59	40	3	2070	1/32
4086 60	50	3	2070	1/32
4086 61	63	3	2070	1/32

* MRP - Maximum Retail Price Inclusive of all taxes including GST.
 ♦ For further details on product contact nearest Legrand Sales Office.

DX³ MCBs

Cat.Nos	Nominal Rating	Number of 17.5 mm modules	MRP* ₹ / Unit	Pack
---------	----------------	---------------------------	---------------	------

Triple pole + Neutral 415 V

4086 65	0.5	4	2268	1/32
4086 66	1	4	2268	1/32
4086 68	2	4	2268	1/32
4086 69	3	4	2268	1/32
4086 70	4	4	2268	1/32
4086 72	6	4	1830	1/32
4086 75	10	4	1830	1/32
4086 77	16	4	1830	1/32
4086 78	20	4	1830	1/32
4086 79	25	4	1830	1/32
4086 80	32	4	1830	1/32
4086 81	40	4	2640	1/32
4086 82	50	4	2640	1/32
4086 83	63	4	2640	1/32

Four pole 415 V

4086 84	0.5	4	2268	1/32
4086 85	1	4	2268	1/32
4086 87	2	4	2268	1/32
4086 88	3	4	2268	1/32
4086 89	4	4	2268	1/32
4086 91	6	4	1830	1/32
4086 94	10	4	1830	1/32
4086 96	16	4	1830	1/32
4086 97	20	4	1830	1/32
4086 98	25	4	1830	1/32
4086 99	32	4	1830	1/32
4087 00	40	4	2640	1/32
4087 01	50	4	2640	1/32
4087 02	63	4	2640	1/32

D Curve

Single pole 240/415 V

4087 06	0.5	1	436	1/10/120
4087 07	1	1	436	1/10/120
4087 09	2	1	436	1/10/120
4087 10	3	1	436	1/10/120
4087 11	4	1	436	1/10/120
4087 12	6	1	360	1/10/120
4087 14	10	1	360	1/10/120
4087 16	16	1	360	1/10/120
4087 17	20	1	360	1/10/120
4087 18	25	1	360	1/10/120
4087 19	32	1	360	1/10/120
4087 20*	40	1	646	1/10/120
4087 21*	50	1	646	1/10/120
4087 22*	63	1	646	1/10/120

Single pole + Neutral 240 V

4087 26	0.5	2	1170	1/5/60
4087 27	1	2	1170	1/5/60
4087 29	2	2	1170	1/5/60
4087 30	3	2	1170	1/5/60
4087 31	4	2	1170	1/5/60

Double pole 415 V

4087 32	0.5	2	1170	1/40
4087 33	1	2	1170	1/40
4087 35	2	2	1170	1/40
4087 36	3	2	1170	1/40
4087 37	4	2	1170	1/40
4087 38	6	2	866	1/40
4087 40	10	2	866	1/40
4087 42	16	2	866	1/40
4087 43	20	2	866	1/40
4087 44	25	2	866	1/40
4087 45	32	2	866	1/40
4087 46*	40	2	1400	1/40
4087 47*	50	2	1400	1/40
4087 48*	63	2	1400	1/40

Bold Cat.Nos are products normally available with Legrand (India) Stockists.
 Cat.Nos that are not bold - delivery within 4 - 8 weeks from the date of order.
 Bold packing quantity is our mandatory packing. Orders to be placed by Legrand (India) Stockist in multiples of the same.

DX³ MCBs

Cat.Nos	Nominal Rating	Number of 17.5 mm modules	MRP* ₹ / Unit	Pack
---------	----------------	---------------------------	---------------	------

Triple pole 415 V

4087 52	0.5	3	1810	1/32
4087 53	1	3	1810	1/32
4087 55	2	3	1810	1/32
4087 56	3	3	1810	1/32
4087 57	4	3	1810	1/32
4087 58	6	3	1426	1/32
4087 60	10	3	1426	1/32
4087 62	16	3	1426	1/32
4087 63	20	3	1426	1/32
4087 64	25	3	1426	1/32
4087 65	32	3	1426	1/32
4087 66*	40	3	2202	1/32
4087 67*	50	3	2202	1/32
4087 68*	63	3	2202	1/32

Triple pole + Neutral 415 V

4087 72	0.5	4	2268	1/32
4087 73	1	4	2268	1/32
4087 75	2	4	2268	1/32
4087 76	3	4	2268	1/32
4087 77	4	4	2268	1/32

Four pole 415 V

4087 78	0.5	4	2268	1/32
4087 79	1	4	2268	1/32
4087 81	2	4	2268	1/32
4087 82	3	4	2268	1/32
4087 83	4	4	2268	1/32
4087 84	6	4	1900	1/32
4087 86	10	4	1900	1/32
4087 88	16	4	1900	1/32
4087 89	20	4	1900	1/32
4087 90	25	4	1900	1/32
4087 91	32	4	1900	1/32
4087 92*	40	4	2742	1/32
4087 93*	50	4	2742	1/32
4087 94*	63	4	2742	1/32

Circuit breakers AC applications 80 - 125 A

10 kA as per IEC 60947-2
Integrated label holder
Sliding insulating shield
Color coded contact indication window
IP 20 protected terminals
50 sq mm terminals

Single pole 230 V / 400 V

4085 99	80	1.5	2232	1/5/160
4086 00	100	1.5	2476	1/5/161
4086 01	125	1.5	2648	1/5/162

Double pole 230 V / 400 V

4086 40	80	3	4926	1/5/60
4086 41	100	3	5204	1/5/60
4086 42	125	3	5666	1/5/60

Triple pole 400 V

4086 62	80	4.5	7764	1/9
4086 63	100	4.5	8194	1/9
4086 64	125	4.5	9004	1/9

Four pole 400 V

4087 03	80	6	10120	1/9
4087 04	100	6	10444	1/9
4087 05	125	6	11700	1/9

* MRP - Maximum Retail Price Inclusive of all taxes including GST.
* For further details on product contact nearest Legrand Sales Office.

DX³ MCBs

Cat.Nos	Nominal Rating	Number of 17.5 mm modules	MRP* ₹ / Unit	Pack
---------	----------------	---------------------------	---------------	------

Circuit breakers DC applications upto 63 A

6 kA as per IEC 60947-2
Integrated label holder
Sliding bottom clamp
Improved air channels
Color coded On/Off indication on dolly
Biconnect lower terminals
IP 20 protected terminals
Sliding shutters

Single pole 250 V

4087 98*	0.5	1	688	1/10/120
4087 99*	1	1	688	1/10/120
4088 01*	2	1	688	1/10/120
4088 02*	3	1	688	1/10/120
4088 03*	4	1	688	1/10/120
4088 04*	6	1	572	1/10/120
4088 06*	10	1	572	1/10/120
4088 08*	16	1	572	1/10/120
4088 09*	20	1	572	1/10/120
4088 10*	25	1	572	1/10/120
4088 11*	32	1	572	1/10/120
4088 12*	40	1	754	1/10/120
4088 13*	50	1	754	1/10/120
4088 14*	63	1	754	1/10/120

Double pole 250 V

4088 15*	0.5	1	1388	1/5/60
4088 16*	1	1	1388	1/5/60
4088 18*	2	1	1388	1/5/60
4088 19*	3	1	1388	1/5/60
4088 20*	4	1	1388	1/5/60
4088 21*	6	1	1216	1/5/60
4088 23*	10	1	1216	1/5/60
4088 25*	16	1	1216	1/5/60
4088 26*	20	1	1216	1/5/60
4088 27*	25	1	1216	1/5/60
4088 28*	32	1	1216	1/5/60
4088 29*	40	1	1532	1/5/60
4088 30*	50	1	1532	1/5/60
4088 31*	63	1	1532	1/5/60

RDSO DC MCB

Single pole

4088 32	0.5	1	672	1/10/120
4088 33	1	1	672	1/10/120
4088 34	1.5	1	672	1/10/120
4088 35	1.6	1	672	1/10/120
4088 36	2.5	1	672	1/10/120
4088 37	3	1	502	1/10/120
4088 38	4	1	502	1/10/120
4088 39	5	1	608	1/10/120
4088 40	10	1	608	1/10/120
4088 41	15	1	608	1/10/120
4088 42	20	1	608	1/10/120
4088 43	25	1	608	1/10/120
4088 44	30	1	722	1/10/120
4088 45	35	1	722	1/10/120
4088 46	40	1	792	1/10/120
4088 47	50	1	792	1/10/120
4088 48	60	1	792	1/10/120

Bold Cat.Nos are products normally available with Legrand (India) Stockists.
Cat.Nos that are not bold - delivery within 4 - 8 weeks from the date of order.
Bold packing quantity is our mandatory packing. Orders to be placed by Legrand (India) Stockist in multiples of the same.



4087 52



4087 90



4086 00



4086 40



4086 63



4087 05



4088 12

DX³ isolators

Cat.Nos	Nominal Rating	Number of 17.5 mm modules	MRP* ₹ / Unit	Pack
---------	----------------	---------------------------	---------------	------

Isolators for AC applications upto 125 A

ISI marked as per IEC 60947-3
 Integrated label holder
 Ergonomic red color dolly
 Sliding bottom clamp
 Double break mechanism
 Improved air channels
 Color coded On/Off indication on dolly
 Biconnect lower terminals
 IP 20 protected terminals
 Sliding shutters

Double pole 240 V

4065 00	32	2	458	1/5/60
4065 01	40	2	504	1/5/60
4065 02	63	2	666	1/5/60
4065 04	100	2	916	1/5/60
4065 05	125	2	1040	1/5/60

Triple pole 415 V

4065 09	32	3	820	1/40
4065 10	40	3	876	1/40
4065 11	63	3	1038	1/40
4065 13	100	3	1170	1/40
4065 14	125	3	1350	1/40

Four pole 415 V

4065 18	32	4	900	1/32
4065 19	40	4	1118	1/32
4065 20	63	4	1224	1/32
4065 22	100	4	1522	1/32
4065 23	125	4	1676	1/32

DX³ RCCBs

RCCBs for AC applications upto 63 A

ISI marked as per IS 12640-1
 Integrated label holder
 Ergonomic Grey color dolly
 Sliding bottom clamp
 Color coded On/Off indication on dolly
 Biconnect lower terminals
 IP 20 protected terminals
 35 sq mm terminals
 Sliding shutters

Double pole 240 V

30 mA

4118 51	25	2	2996	1/5/60
4118 52	40	2	3508	1/5/60
4118 53	63	2	4194	1/5/60

100 mA

4118 56	25	2	3230	1/5/60
4118 57	40	2	3748	1/5/60
4118 58	63	2	4452	1/5/60

300 mA

4118 61	25	2	3288	1/5/60
4118 62	40	2	3830	1/5/60
4118 63	63	2	4480	1/5/60

Four pole 415 V

30 mA

4118 76	25	4	4128	1/32
4118 77	40	4	4078	1/32
4118 78	63	4	4730	1/32

* MRP - Maximum Retail Price Inclusive of all taxes including GST.

DX³ RCCBs

Cat.Nos	Nominal Rating	Number of 17.5 mm modules	MRP* ₹ / Unit	Pack
---------	----------------	---------------------------	---------------	------

100 mA

4118 81	25	4	4282	1/32
4118 82	40	4	4310	1/32
4118 83	63	4	5086	1/32

300 mA

4118 86	25	4	4386	1/32
4118 87	40	4	4452	1/32
4118 88	63	4	5086	1/32

Four pole 415 V, A-S

300 mA

4118 91	25	2	6356	1/5/60
4118 92	40	2	6438	1/5/60
4118 93	63	2	6724	1/5/60
4118 94	80	2	7866	1/5/60

Double pole 240 V, HPI

30 mA

4118 71	25	2	6270	1/5/60
4118 72	40	2	6584	1/5/60
4118 73	63	2	6774	1/5/60
4118 74	80	2	8128	1/5/60

Four pole 415 V, HPI

30 mA

4118 96	25	4	7062	1/32
4118 97	40	4	7284	1/32
4118 98	63	4	7474	1/32
4118 99	80	4	8442	1/32

DX³ circuit breakers

AC applications upto 100 A

Integrated label holder
 Ergonomic Grey color dolly
 Color coded On/Off indication on dolly
 Biconnect lower terminals
 IP 20 protected terminals
 35 sq mm terminals
 Sliding shutters

Double pole 240 V

30 mA

4115 07	80	2	7006	1/5/60
4115 08	100	2	7616	1/5/60

100 mA

4115 17	80	2	7006	1/5/60
4115 18	100	2	7254	1/5/60

300 mA

4115 27	80	2	7006	1/5/60
4115 28	100	2	7616	1/5/60

Four pole 415 V

30 mA

4117 05	80	4	8226	1/32
4117 63	100	4	7518	1/32

100 mA

4117 15	80	4	8226	1/32
4117 73	100	4	7518	1/32

300 mA

4117 25	80	4	8226	1/32
4117 83	100	4	7682	1/32

Bold Cat.Nos are products normally available with Legrand (India) Stockists. Cat.Nos that are not bold - delivery within 4 - 8 weeks from the date of order. Bold packing quantity is our mandatory packing. Orders to be placed by Legrand (India) Stockist in multiples of the same.

DX³ RCD add on module

Cat.Nos	Nominal Rating	Number of 17.5 mm modules	MRP* ₹ / Unit	Pack
---------	----------------	---------------------------	---------------	------

Four pole 415 V, AC Type

30 mA

4106 25	125 A	4	20452	1
---------	-------	---	-------	---

100 mA

4106 26	125 A	4	22854	1
---------	-------	---	-------	---

300 mA

4106 29	125 A	4	22854	1
---------	-------	---	-------	---

Double pole 240 V, HPI type

30 mA

4105 78	125 A	6	16492	1
---------	-------	---	-------	---

100 mA

4105 79	125 A	6	18434	1
---------	-------	---	-------	---

300 mA

4105 82	125 A	6	18434	1
---------	-------	---	-------	---

Four pole 415 V, HPI type

30 mA

4106 38	125 A	6	28272	1
---------	-------	---	-------	---

100 mA

4106 39	125 A	6	29922	1
---------	-------	---	-------	---

300 mA

4106 42	125 A	6	29922	1
---------	-------	---	-------	---

DX³ auxiliaries

Auxiliaries common for MCBs, Isolators, RCCBs & RCBOs

Easy & fast fixation on site
On site clip on mounting
Clip on fitting on left side

Cat.Nos	Description	Number of 17.5 mm modules	MRP* ₹ / Unit	Pack
---------	-------------	---------------------------	---------------	------

Signalling auxiliaries

4062 50	Auxiliary changeover switch 6 A	0.5	820	1
4062 52	Fault signalling changeover switch 6 A	0.5	962	1
4062 64	Changeover + fault signalling switch	1	1546	1

Control auxiliaries

4062 76	Shunt release 12 /48 V AC/DC	1	2240	1
4062 78	Shunt release 110/415 V V AC	1	2240	1
4062 80	Undervoltage release 24/48 V AC/DC	1	1958	1
4062 82	Undervoltage release 230 V AC	1	1924	1

* MRP - Maximum Retail Price Inclusive of all taxes including GST.

DX³ auxiliaries

Cat.Nos	Description	Number of 17.5 mm modules	MRP* ₹ / Unit	Pack
---------	-------------	---------------------------	---------------	------

Control auxiliaries

4062 86	Pop over voltage release	1	2432	1
4062 90	Motor control 24/48 V AC/DC	1	12080	1
4062 91	Motor control 110/415 V AC	1	9292	1
4062 93	Motor control 24/48 V AC/DC	2	20904	1
4062 95	Motor control 110/415 V AC	2	20904	1
4062 88	Automatic resetter	2	9292	1
4062 89	Automatic resetter with autotest	2	13936	1

Rotary handle

4063 19	Black rotary handle	-	1858	10
4063 20	Yellow/red rotary handle	-	2090	10

Support for padlock

4063 03	Support for padlock till 63 A	-	434	10
---------	-------------------------------	---	-----	----

Sealable screw cover

4063 04	Devices upto 63 A	-	442	10
4063 06	For 80-125 A devices	-	4832	10

1/2 module spacing unit

4063 07	1/2 module spacing unit	0.5	164	10
---------	-------------------------	-----	-----	----

5 mm padlock

4063 13	5 mm Padlock	-	348	10
---------	--------------	---	-----	----

Manual changover switch

Compact design
Manual switching operation
Easy to assemble
Ergonomic design

For 1 mod/pole devices

4063 14	Manual change-over switch for DP	1	2090	5
4063 15	Manual change-over switch for TP	1	2556	5
4063 16	Manual change-over switch for FP	1	2786	5

Bold Cat.Nos are products normally available with Legrand (India) Stockists. Cat.Nos that are not bold - delivery within 4 - 8 weeks from the date of order. **Bold packing quantity** is our mandatory packing. Orders to be placed by Legrand (India) Stockist in multiples of the same.

DX³ RCD add on module with measurement & metering

Cat.Nos	Nominal Rating	Number of 17.5 mm modules	MRP* ₹ / Unit	Pack
---------	----------------	---------------------------	---------------	------

Conform to IEC 61009-1
Hpi type: detect faults with AC and DC components, increased
Immunity to false tripping
Inbuilt measurement/metering option
Measurement - V, A, F, PF, KWh, KVA, KVAr, THD
Metering - V, A, F, KWh
RS 485 port for remote reading
Di-electric test button inbuilt
Ergonomic test button
Scroll button for easy readings
RLCD display on front facia
For mounting on the right-hand side of 1.5 module per pole DX³ MCBs
Easy & fast association mechanism
70 sq mm terminals

Adjustable metering, four pole 415 V

4106 57	63 A	7	14164	1
4106 58	125 A	7	25962	1

Adjustable measurement

4106 59	125 A	7	28592	1
---------	-------	---	-------	---

DX³ time switches

Cat.Nos	Description	MRP* ₹ / Unit	Pack
---------	-------------	---------------	------

Time switches

AlphaRex³ digital time switches

Daily and weekly time switch
Quick and easy programming due to the option to select day blocks, day blocks can be individually set or selected from the blocks Mon-Sun, Mon-Fri or Sat-Sun
Programming with precision to the second
Switch times visible in weekly overview on display

4126 31	AlphaRex ³ D21, 1 channel	4510	1
4126 41	AlphaRex ³ D22, 2 channels	6766	1
4126 34	AlphaRex ³ D21s, 1 channel	5364	1

AlphaRex³ digital time switches - Astro

- For switching on/off lights and other electric devices according to the rising/setting of the sun
- With combination function for creating switching programs in which the devices are switched according to astronomical time and/or fixed preset times
- Daily astronomical calculation of the sunrise/sunset times based on the entered location or location coordinates

4126 54	AlphaRex ³ D21 astro, 1 channel	9024	1
4126 57	AlphaRex ³ D22 astro, 2 channels	10376	1

AlphaRex³ yearly time switch

- Yearly and weekly time switch with additional astronomical function for all channels
- 84 switching programs per channel, comprising:
 - 28 weekly programs
 - 28 yearly programs
 - 28 special programs (priority program)

4126 29	AlphaRex ³ DY21, 1 channel	24586	1
4126 30	AlphaRex ³ DY22, 2 channels	25292	1

* MRP - Maximum Retail Price Inclusive of all taxes including GST.



4106 57



4126 41



4126 54



4126 57



4126 29



4128 12



4128 14



4125 44

DX³ time switches

Cat.Nos	Description	MRP* ₹ / Unit	Pack
---------	-------------	---------------	------

Programming accessories

4128 72	Data key	1312	1
4128 73	PC adapter for USB port	4470	1

Twilight switches

- Including light sensor
- Wire for light sensor: 2 x 1.5 mm², maximum wire length: 50 m
- LED switching status indicator

4126 23	Luxo switch	6088	1
---------	-------------	------	---

MicroRex analog time switches

In accordance with IEC 60730-1 and 60730-2-7
Manual switching ON/automatic/OFF
Hourly/daily/weekly switching dial with captive segments
Clock precision: +/- 5 min for the daily time switch
-10 °C to +55 °C operating temperature

4128 23	MicroRex T31 Su/Wi – Daily time switch	5692	1
4128 28	MicroRex W31 Su/Wi – Weekly time switch	6090	1

MicroRex analog time switches

4128 12	MicroRex T31 – Daily time switch	4554	1
4128 13	MicroRex QT31 – Daily time switch	5106	1
4128 14	MicroRex W31 – Weekly time switch	5466	1
4127 90	MicroRex QT11 – Daily time switch	3188	1
4127 94	MicroRex QW11 – Weekly time switch	3680	1

Accessory

4128 59	Wall bracket	944	1
---------	--------------	-----	---

DX³ contactors

Power contactors CX³

Conform to IEC/EN 61095
Space for power supply busbar on top (up to 25 A)

4125 44	25 A 2 NO contactor	1816	1
4125 45	40 A 2 NO contactor	3102	1
4125 47	63 A 2 NO contactor	3608	1
4125 48	63 A 2 NC contactor	3608	1
4125 49	40 A 3 NO contactor	5186	1
4125 50	63 A 3 NO contactor	5866	1
4125 51	25 A 4 NO contactor	2144	1
4125 53	40 A 4 NO contactor	5472	1
4125 56	63 A 4 NO contactor	6480	1
4125 57	63 A 4 NC contactor	6542	1

Signalling auxiliaries for contactors

Auxiliary changeover switch

4124 29	For 1 module contactors 16 A to 25 A	2740	1
4124 30	For 2 module contactors 25 A	2750	1
4124 31	For 40 and 63 A contactors	3608	1

Bold Cat.Nos are products normally available with Legrand (India) Stockists. Cat.Nos that are not bold - delivery within 4 - 8 weeks from the date of order. Bold packing quantity is our mandatory packing. Orders to be placed by Legrand (India) Stockist in multiples of the same.

DX³ for photovoltaic applications

Cat.Nos	Description	MRP* ₹ / Unit	Pack
---------	-------------	------------------	------

DC MCBs

Breaking capacity 4.5 kA according to EN 60947-2

800 V_{DC} circuit breakers

4144 24	6 A	■	1
4144 25	8 A	■	1
4144 26	10 A	■	1
4144 27	13 A	■	1
4144 28	16 A	■	1
4144 29	20 A	■	1

1000 V_{DC} circuit breakers

4144 46	10 A	■	1
4144 47	13 A	■	1
4144 48	16 A	■	1
4144 49	20 A	■	1
4144 50	25 A	■	1
4144 51	32 A	■	1

Type 2 voltage surge protectors

DC side protection of photovoltaic installations connected to the low voltage network (without energy storage system)
Conforming to UTE guide C 61-740-51
Protection in common mode and residual current mode (Y mode) 1
Consisting of plug-in modules with LED indicator
Red: modules need to be replaced

Voltage surge protectors

4141 60	600 V= 25KA I _{max}	■	1
4141 51	1000 V 40KA I _{max}	■	1

Plug-in replacement module

4141 90	+/- cassette for voltage surge protector 4141 60	■	1
4141 91	T cassette for voltage surge protector 4141 60	■	1
4141 81	+/- and T cassette for voltage surge protector 4141 51	■	1

DC rotary handle isolating switches

Category of use DC 21B according to EN 60947-3
Double break contacts

600 V_{DC} isolating switches

4142 61	16 A	■	1
4142 62	25 A	■	1
4142 63	32 A	■	1

1000 V_{DC} isolating switches

4142 81	16 A	■	1
4142 82	25 A	■	1
4142 83	32 A	■	1

Accessories

4063 05	Pole separation divider	■	1
4063 07	Spacing unit 0.5 unit	■	10

■ Price available on request.

* MRP - Maximum Retail Price Inclusive of all taxes including GST.

SURGE PROTECTIVE DEVICES

Solutions for all installations and risk levels

Clear, easily identifiable marking for easier maintenance, design in line with other Legrand modular equipment, well thought features: the new SPDs integrate perfectly in the modular rows of Legrand distribution boards and protects sensitive equipment.



Easier to handle: the plug-in modules are easy to replace thanks to the extraction handles.

Status indicator and remote monitoring of information



1 Fault signal contact

2 Status indicator

Design and marking

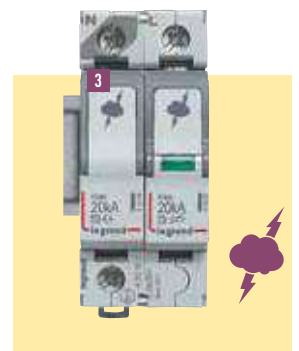

3 Dedicated marking for easier identification and maintenance of the SPDs.

Bold Cat.Nos are products normally available with Legrand (India) Stockists. Cat.Nos that are not bold - delivery within 4 - 8 weeks from the date of order. Bold packing quantity is our mandatory packing. Orders to be placed by Legrand (India) Stockist in multiples of the same.

Class I (T1) low voltage SPDs

Cat.Nos	Number of poles	Neutral position	Total (10/350)	Remote status monitoring (if contract)	Number of modules	MRP* ₹ / Unit	Pack
---------	-----------------	------------------	----------------	--	-------------------	---------------	------

SPDs for general protection of main distribution board

T1+T2 - limp 12,5 kA/pole T2 - 60 kA

4122 70	1P	-	12.5 kA	No	1	7378	1
4122 76 ¹	1P+N	Right	25 kA	Yes	2	14754	1
4122 71	2P	-	25 kA	No	2	14250	1
4122 72	3P	-	37.5 kA	Yes	3	20076	1
4122 77 ¹	3P+N	Right	50 kA	Yes	4	26900	1
4122 73	4P	-	50 kA	No	4	24624	1

T1+T2 - limp 8 kA/pole T2 - 60 kA

4122 50	1P	-	8 kA	No	1	7006	1
4122 56 ¹	1P+N	Right	16 kA	No	2	12742	1
4122 51	2P	-	16 kA	No	2	13536	1
4122 52	3P	-	25 kA	No	3	19070	1
4122 57 ¹	3P+N	Right	25 kA	No	4	23176	1
4122 53	4P	-	32 kA	No	4	24562	1

SPDs for high risk level installations

T1 - limp 50 kA/pole - 440 V~ (IT) - Monobloc

0030 00 ²	1P	-	50 kA	No	2	6912	1
----------------------	----	---	-------	----	---	------	---

T1 - limp 35 kA/pole - 440 V± (IT) - Plug-in

4122 80	1P	-	35 kA	Yes	2	6534	1
---------	----	---	-------	-----	---	------	---

T1 - limp 25 kA/pole

4122 81 ¹	1P+N	Right	50 kA	Yes	4	8488	1
4122 82	3P	-	75 kA	Yes	6	44118	1
4122 83 ¹	3P+N	Right	100 kA	Yes	8	48528	1

Replacement plug-in modules

Cat.Nos	Description	MRP* ₹ / Unit	Pack
---------	-------------	---------------	------

4123 02	For SPDs T1+T2 - 8 kA Cat.Nos 4122 50/ 51/52/53/56/57	5742	1
4123 03	For SPDs T1+T2 - 12.5 kA Cat.Nos 4122 70/ 71/72/73/76/77	5416	1
4122 84	For SPDs T1 - 25 kA Cat.Nos 4122 81/82/83 and 0030 20/22/23/27	15588	1
4122 85	N-PE module for SPDs T1 - 25 kA Cat.Nos 4122 81/83 and 0030 23	21156	1
4122 86	For SPDs T1 - 35 kA Cat.No 4122 80	5228	1

Cabling accessories

4123 10	Ready to use cabling kit consisting of 5 conductors (including the earth conductor) Cross section :16 mm ² Length : 40 cm For cabling SPDs in industrial enclosures (for EN/IEC 61439 compliance).	1120	1
---------	--	------	---

* MRP - Maximum Retail Price Inclusive of all taxes including GST.

¹ 1P+N and 3P+N: L-N and N-PE protection modes (common and differential modes), the N pole being protected by encapsulated spark gaps. Also called sometimes 1+1 and 3+1

² Replaced mid 2015 by Cat.No 4122 80

Class II (T2) low voltage SPDs

Cat.Nos	Number of poles	Neutral position	Remote status monitoring (if contract)	Number of modules	MRP* ₹ / Unit	Pack
---------	-----------------	------------------	--	-------------------	---------------	------

T2 SPDs

T2 - I_{max} 40 kA/pole

4122 40	1P	-	No	1	5062	1
4122 46 ¹	1P+N	Right	No	2	9640	1
4122 41	2P	-	No	2	9640	1
4122 42	3P	-	Yes	3	14118	1
4122 47 ¹	3P+N	Right	No	4	17182	1
4122 43	4P	-	No	4	17182	1

T2 - I_{max} 40 kA/pole - 440 V~ (IT)

4122 30	1P	-	No	1	6704	1
4122 32	3P	-	Yes	3	20076	1
4122 33	4P	-	Yes	4	24624	1

T2 - I_{max} 20 kA/pole

4122 20	1P	-	No	1	3458	1
4122 26 ¹	1P+N	Right	No	2	7542	1
4122 21	2P	-	No	2	7542	1
4122 27 ¹	3P+N	Right	No	4	14040	1
4122 23	4P	-	No	4	14040	1

Replacement plug-in modules

Cat.Nos	Description	MRP* ₹ / Unit	Pack
---------	-------------	---------------	------

4122 99	For SPDs T2 - 40 kA Cat.Nos 4122 40/ 41/42/43/44/45/ 46/47/66/67	3696	1
4123 00	N-PE module for SPDs T2 - 40 kA Cat.Nos 4122 46/47	7396	1
4123 01	For SPDs T2 - 440 V Cat.Nos 4122 30/32/33	5688	1
4122 97	For SPDs T2 - 20 kA Cat.Nos 4122 20/ 21/23/26/27/62/63	2794	1
4123 98	N-PE module for SPDs T2 - 20 kA Cat.Nos 4122 24/25/26/27	5952	1

Bold Cat.Nos are products normally available with Legrand (India) Stockists. Cat.Nos that are not bold - delivery within 4 - 8 weeks from the date of order. Bold packing quantity is our mandatory packing. Orders to be placed by Legrand (India) Stockist in multiples of the same.



4122 57



4122 43



4122 83



4123 03



4122 84



4122 99

Class II (T2) low voltage SPDs with integrated protection

Cat.Nos	Number of poles	Neutral position	Integrated protection	Number of modules	MRP* ₹ / Unit	Pack
---------	-----------------	------------------	-----------------------	-------------------	------------------	------

Protection for consumer units

T2 self protected SPDs - I_{max} 12 kA/pole

0039 51 ¹	1P+N	Left	I _{sc} ≤ 6 kA	2	9232	1
0039 53 ¹	3P+N	Left	I _{sc} ≤ 6 kA	6	20138	1



0039 51



0039 53

Protection for secondary distribution boards

T2 self protected SPDs - I_{max} 12 kA/pole

0039 71 ¹	1P+N	Left	I _{sc} ≤ 10 kA	2	7642	1
0039 73 ¹	3P+N	Left	I _{sc} ≤ 10 kA	6	14458	1

Replacement plug-in modules

Cat.Nos	Description	MRP* ₹ / Unit	Pack
---------	-------------	------------------	------

For self protected SPDs

0039 54	Cat.Nos 0039 51/53	5990	1
0039 74	Cat.Nos 0039 71/73	6196	1



0039 54

For old SPDs

0039 28	Cat.Nos 0039 20/21/22/23	6346	1
0039 34	Cat.Nos 0039 30/31/32/33	5630	1
0039 39	Cat.Nos 0039 35/36/38	4868	1
0039 44	Cat.Nos 0039 40/41/43	3898	1

SPDs for telephone lines

Cat.Nos	In/I _{max}	Max. voltage (Uc)	Level of protection (Up)	No. of modules	MRP* ₹ / Unit	Pack
---------	---------------------	-------------------	--------------------------	----------------	------------------	------

SPDs for telephone and data lines

"Analogue" SPD (STN, non-unbundled ADSL, etc.)

0038 28	5/10 kA	170 V	260 V	1	11372	1
---------	---------	-------	-------	---	-------	---



0038 28

"Digital" SPD (unbundled ADSL, SDSL, ISDN, etc.)

0038 29	5/10 kA	48 V	100 V	1	11354	1
---------	---------	------	-------	---	-------	---



0038 29

* MRP - Maximum Retail Price Inclusive of all taxes including GST.
¹ 1P+N and 3P+N: L-N and N-PE protection modes (common and differential modes), the N pole being protected by encapsulated spark gaps. Also called sometimes 1+1 and 3+1

ZUCCHINI™

Busbar Trunking System

For Industrial, commercial, residential and service sector buildings.

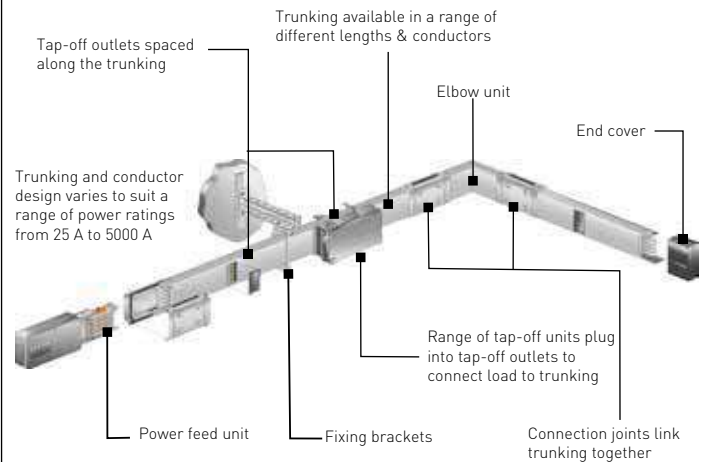

Exclusive features

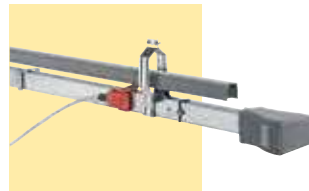

Low Power (25 A, 40 A, 63 A)

- Lighting busway
- 2, 4 & 6 pole
- IP 55 protection
- Tap off units at each 0.5 mt interval
- Copper busbars



Medium Power (63 A - 1000 A)

- Riser mains application
- IP 40, IP 52, IP 55 protection
- Tap off units at each 1 mt interval
- Aluminium & copper busbars

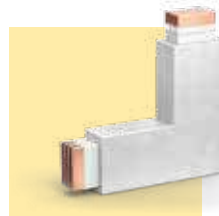

Cast Resin Busbar (630 A - 6300 A)

- Fully insulated with epoxy resin
- IP86 suited for outdoor
- Industrial plants, Petrochemical plants, Chemical plants in areas with risk of flooding.

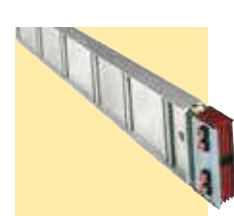

Super Compact (630 A - 6300 A)

- Sandwich type construction
- IP 65 protection
- Tap off boxes at each 1 mt interval
- Aluminium & copper busbars

discover more on : www.zucchini spa.it



for product enquires and prices please contact Legrand personnel

Bold Cat.Nos are products normally available with Legrand (India) Stockists. Cat.Nos that are not bold - delivery within 4 - 8 weeks from the date of order. **Bold packing quantity** is our mandatory packing. Orders to be placed by Legrand (India) Stockist in multiples of the same.

DX³ changeover switches

Cat.Nos	Description	MRP* ₹ / Unit	Pack
---------	-------------	------------------	------

Changeover Switches

Single pole - two way - 250 V AC

4129 00	32 A	3022	10/100
---------	------	------	--------

Double pole - two way - 400 V AC

4129 01	32 A	3022	5/50
---------	------	------	------

Double pole - two way with centre off - 400 V AC

4129 03	32 A	3164	5/50
---------	------	------	------

Four pole - two way with centre off - 400 V AC

6040 22	40 A	4690	2/20
---------	------	------	------

DX³ push button

Push button cum switch

Push button cum switch - 1 module - 20 A-250 V AC

Single function

4129 08	Contact 1 NO	2636	10/100
4129 09	Contact 1 NC	2636	10/60
4129 10	Contact 2 NO	2636	10/60

Dual function

4129 14	Contact - 1 NO + green indicator	2636	10/100
4129 15	Contact - 1 NC + red indicator	2636	10/60

DX³ indicators

Single indicators - 1 module - 250 V AC

Possible to replace E10 lamps and diffusers.
E10 - 1.2 Watt, 230 V AC

4129 26	Colour - Green	660	10/100
4129 27	Colour - Red	660	10/100
4129 28	Colour - Orange	660	10/100
4129 29	Colour - Blue	660	10/100
4129 32	White + White + White	1318	10/100
4129 33	Red + Red + Red	1318	10/100
4129 34	Red + Yellow + Green	1790	10/100
4129 35	Red + Yellow + Blue	1318	10/100

Lexic dimmer

Dimmer

1000 W remote dimmer

0036 71	1000 W universal remote control dimmer 6 module	38200	1/10
---------	---	-------	------

Lexic time switches

Multifunction time delay relay

- Supply voltage : 12 to 230 V AC 50/60 Hz and DC
- Output : 8 A - 250 V AC, $\cos\phi = 1$
- Contact NO

0047 44	Multifunction time delay relay	12564	1
---------	-----------------------------------	-------	---

* MRP - Maximum Retail Price Inclusive of all taxes including GST.

Rex modular time switches

Cat.Nos	Description	MRP* ₹ / Unit	Pack
---------	-------------	------------------	------

Time lag switch

0047 02	Time lag switch long time (1 module)	6510	10/100
---------	---	------	--------

Rex surface mounting time switches

MaxiRex

6499 15	MaxiRex 4QT (daily)	5214	1/30
6499 14A	MaxiRex 4QTB (daily with IP 53 box)	6018	1
6499 39	MaxiRex 5QW (weekly)	5734	1/30
6499 36A	MaxiRex 4QWB (weekly with IP 53 box)	7028	1

EconoRex

0499 86	EconoRex MQT (24 hrs.)	5488	1/30
---------	------------------------	------	------

Accessories

0498 32	Clip on support frame for facia mounting of MaxiRex QTT and QWT	358	1/5
0044 09	DIN rail adaptor for MaxiRex QTT and QWT	246	1
0044 07	DIN rail adaptor for EconoRex BQTAP	260	1
6499 49	Terminal cover for 4/5 nominal time switch	260	1/30
6499 48	IP53 box for MaxiRex 4 and 5	846	1/10

Lexic ammeters

Analogue ammeter

Measures the intensity of the current circulating in an electrical circuit in Amperes (A)

0046 02	Direct connection to alternating or direct current range : 0 - 30 A (4 modules)	5566	1/12
0046 00	Connected using a 5 A current transformer (CT) the meter is fitted with an appropriate dial for the intensity of the current being measured (4 modules)	5566	1/12

Measuring dials for ammeter Cat.No 0046 00

0046 10	0 - 50 A	326	2/84
0046 13	0 - 100 A	326	2/84
0046 15	0 - 200 A	326	2/84
0046 17	0 - 300 A	326	2/84
0046 18	0 - 400 A	326	2/84
0046 20	0 - 600 A	326	2/84
0046 21	0 - 800 A	326	2/84
0046 22	0 - 1000 A	326	2/84

Current transformers

- Used with ammeters, electricity meters
- Supply a current of 5 A to the secondary which is proportional to the primary current.
- Fix to plate or rail EN 60715

4121 01	50/5 Precision in % - 1 Power in VA - 1.5	2538	1/12
4121 03	100/5 Precision in % - 1 Power in VA - 1.5	3388	1/12

Bold Cat.Nos are products normally available with Legrand (India) Stockists. Cat.Nos that are not bold - delivery within 4 - 8 weeks from the date of order. Bold packing quantity is our mandatory packing. Orders to be placed by Legrand (India) Stockist in multiples of the same.

Lexic ammeters

Cat.Nos	Description	MRP* ₹ / Unit	Pack
Current transformers			
4121 06	200/5 Precision in % - 0.5 Power in VA - 4	3388	1/12
4121 24	300/5 Precision in % - 0.5 Power in VA - 5	3388	1/12
4121 25	400/5 Precision in % - 0.5 Power in VA - 8	3510	1/12
4121 36	600/5 Precision in % - 0.5 Power in VA - 12	3562	1/12
4121 38	800/5 Precision in % - 0.5 Power in VA - 8	5218	1/12
4121 39	1000/5 Precision in % - 0.5 Power in VA - 10	5512	1/12
4121 42	1250/5 Precision in % - 0.5 Power in VA - 12	6432	1/12

Lexic voltmeters

Analogue voltmeter

Used to measure the AC or DC voltage (V) in an electrical circuit

0046 60	Range 0-500 V - 4 M [▲]	5840	1/12
---------	----------------------------------	------	------

Digital ammeter / voltmeter

0046 63	0-1200 A, 0-500 V	14682	1
---------	-------------------	-------	---



0046 63

Lexic selector switches

Selector switches

For manual switching of circuits being measured

4-position ammeter selector switch

0046 50	For measuring currents in a 3-phase circuit using only 1 ammeter with a current transformer - 3 M [▲]	6106	1/20
---------	--	------	------

4-position voltmeter selector switch

0046 52	For measuring phase-to-phase voltages of a 3-phase circuit without neutral using only 1 voltmeter - 3 M [▲]	5606	1/20
---------	--	------	------



0046 52

7-position voltmeter selector switch

0046 53	For measuring phase-to-phase voltages and phase-neutral voltages of a 3-phase circuit with neutral - 3 M [▲]	5910	1/20
---------	---	------	------



0046 53

Ekinox³ reinvented energy distribution



Ekinox³

**Ekinox³ reinvented
electrical safety**

Refer p. 52-55

With Ekinox³, we've pushed best to a better level. While others have designed countless variations of distribution boards, no one has really understood the need and complexities of projects with variable power requirements.

* MRP - Maximum Retail Price Inclusive of all taxes including GST.
▲ M = Module

Bold Cat.Nos are products normally available with Legrand (India) Stockists. Cat.Nos that are not bold - delivery within 4 - 8 weeks from the date of order. Bold packing quantity is our mandatory packing. Orders to be placed by Legrand (India) Stockist in multiples of the same.

Uncompromising performance for motor protection and control

A complete range of devices for the protection and control of motors



CTX³ CONTACTORS AND RTX³ THERMAL RELAYS UP TO 800 A

- Compact size
- High mechanical and electrical endurance for maximum reliability
- 3 pole and 4 pole contactors
- Screw terminals
- Complete range of auxiliaries and accessories



MPX³ MOTOR PROTECTION CIRCUIT BREAKERS UP TO 100 A

- High breaking capacity and type 2 coordination for an optimum service level
- Trip class 10
- Sensitive to phase loss
- Compact size
- Can be fixed on 35 mm DIN rail or using screws
- Easy combination with CTX³ 3 pole contactors
- Complete range of control and signalling auxiliaries and accessories



Ekinox³ reinvented energy distribution

Ekinox³ is an experience unlike any other. Imagine a distribution board built with incredible features which keep you away from the worry of constantly maintaining it. Ekinox³ is designed to work as beautifully as it looks.



Ekinox³ SPN DB's

for DX³ MCB, Isolator, RCCB and RCBO

Cat.Nos	Number of ways	No. of modules	MRP* ₹ / Unit	Pack
---------	----------------	----------------	------------------	------

- As per IEC 61439-3
- Suitable for Flush Mounting and Surface Mounting
- With 100 A Copper Busbar
- With Neutral bar, Earthbar and Cable ties for Cable management
- Fully shrouded Neutral bars
- Prefitted masking sheet
- Reversible Door for IP 43 & IP 54 DB's

IP 30 - #IK 08

5076 00	4 way	4	1224	1
5076 01	8 way	8	1536	1
5076 02	12 way	12	1818	1
5076 03	16 way	16	2240	1
5076 04	18 way	18	2610	1
5076 05	20 way	20	2680	1



5076 05

IP 43 - #IK 09 with metal door

5076 10	4 way	4	1644	1
5076 11	8 way	8	2040	1
5076 12	12 way	12	2450	1
5076 13	16 way	16	3076	1
5076 14	18 way	18	3136	1
5076 15	20 way	20	3804	1



5076 12

IP 43 - #IK 09 with acrylic door

5076 20	4 way	4	2098	1
5076 21	8 way	8	2428	1
5076 22	12 way	12	2950	1
5076 23	16 way	16	3666	1
5076 24	18 way	18	4022	1
5076 25	20 way	20	4300	1



5076 42

IP 54 - #IK 09

5076 40	4 way	4	5508	1
5076 41	8 way	8	6476	1
5076 42	12 way	12	7438	1
5076 43	16 way	16	8276	1
5076 44	18 way	18	8696	1
5076 45	20 way	20	9182	1

Ekinox³ ETPN DB's

for DX³ MCB, Isolator, RCCB and RCBO

- As per IEC 61439-3
- Suitable for Flush Mounting and Surface Mounting
- With 100 A Copper Busbar for each phase
- With Neutral bar, Earthbar and Cable ties for Cable management
- Fully insulated busbar & shrouded Neutral bars
- Improved Pan assembly for ease of installation
- Prefitted masking sheet
- Reversible Door for IP 43 & IP 54 DB's
- With provision for FP MCB/Isolator/RCCB/RCBO as incomer and SP MCB's as outgoing
- Supplied with wireset
- Can be converted to PPI DB at site using conversion kit

IP 30 - #IK 08

5076 60	4 way	8+12	3380	1
5076 61	6 way	8+18	4170	1
5076 62	8 way	8+24	4902	1
5076 63	12 way	8+36	7264	1
5076 64	16 way	8+48	8954	1
5076 66	20 way	8+60	12494	1



5076 61

* MRP - Maximum Retail Price Inclusive of all taxes including GST.
#IK - Refer pg - 57 for ready reckoner table.

Ekinox³ ETPN DB's

for DX³ MCB, Isolator, RCCB and RCBO

Cat.Nos	Number of ways	No. of modules	MRP* ₹ / Unit	Pack
---------	----------------	----------------	------------------	------

IP 43 - #IK 09 with metal door

5076 70	4 way	8+12	4018	1
5076 71	6 way	8+18	4956	1
5076 72	8 way	8+24	5944	1
5076 73	12 way	8+36	8902	1
5076 74	16 way	8+48	11036	1
5076 76	20 way	8+60	15450	1



5076 82

IP 43 - #IK 09 with acrylic door

5076 80	4 way	8+12	5222	1
5076 81	6 way	8+18	6450	1
5076 82	8 way	8+24	7738	1
5076 83	12 way	8+36	11868	1
5076 84	16 way	8+48	14240	1
5076 86	20 way	8+60	19934	1

IP 54 - #IK 09

5076 90	4 way	8+12	13126	1
5076 91	6 way	8+18	15794	1
5076 92	8 way	8+24	17274	1
5076 93	12 way	8+36	24344	1
5076 94	16 way	8+48	29216	1
5076 96	20 way	8+60	36554	1

Ekinox³ Flexy DB

for DX³ DIN modular products

Cat.Nos	Number of row	No. of modules	MRP* ₹ / Unit	Pack
---------	---------------	----------------	------------------	------

- As per IEC 61439-3
- Suitable for Flush Mounting and Surface Mounting
- Completely flexible to organise the distribution as per site requirements
- Busbars to be selected as per distribution requirements
- With Neutral and Earth bars
- Fully shrouded Neutral bars
- Improved Pan assembly for ease of installation
- Prefitted masking sheet
- Reversible door for IP 43

IP 30 - #K 08

5077 01	2 row of 14 M	28	4282	1
5077 02	3 row of 14 M	42	5140	1
5077 03	4 row of 14 M	56	5888	1



5077 01

IP 43 - #IK 09 with metal door

5077 05	2 row of 14 M	28	5050	1
5077 06	3 row of 4 M	42	6066	1
5077 07	4 row of 14 M	56	6608	1
5077 14	4 row of 8 M	32	5308	1
5077 15	4 row of 10 M	40	5504	1
5077 12	3 row of 14 M MCCB for DPX ³ 160 MCCB	42	6670	1

IP 43 - #IK 09 with acrylic door

5077 09	2 row of 14 M	28	5340	1
5077 10	3 row of 14 M	42	6550	1
5077 11	4 row of 14 M	56	7420	1
5077 13	3 row of 14 M MCCB for DPX ³ 160 MCCB	42	7864	1



5077 11

Bold Cat.Nos are products normally available with Legrand (India) Stockists.
Cat.Nos that are not bold - delivery within 4 - 8 weeks from the date of order.
Bold packing quantity is our mandatory packing. Orders to be placed by Legrand (India) Stockist in multiples of the same.

Ekinox³ TPN DB-VTPN DB's

for DX³ MCB, Isolator, RCCB and RCBO

Cat.Nos	Number of ways	No. of modules	MRP* ₹ / Unit	Pack
---------	----------------	----------------	------------------	------

- As per IEC 61439-3
- Suitable for Flush Mounting and Surface Mounting
- With 100 A Copper Busbar for each phase
- With 2 Neutral bar, 2 Earthbar and Cable ties for Cable management
- Fully insulated busbar & shrouded Neutral bars
- Improved Pan assembly for ease of installation
- Prefitted masking sheet
- Reversible Door for IP 43 & IP 54 DB's
- With provision for FP MCB/Isolator/RCCB/RCBO as incomer and SP/TP MCB's as outgoing

IP 30 - #IK 08

5077 20	4 way	8+12	9426	1
5077 21	6 way	8+18	10368	1
5077 22	8 way	8+24	11508	1
5077 23	12 way	8+36	16618	1

IP 43 - #IK 09 with metal door

5077 25	4 way	8+12	9908	1
5077 26	6 way	8+18	10900	1
5077 27	8 way	8+24	12602	1
5077 28	12 way	8+36	16956	1

IP 43 - #IK 09 with acrylic door

5077 30	4 way	8+12	13420	1
5077 31	6 way	8+18	14762	1
5077 32	8 way	8+24	17060	1
5077 33	12 way	8+36	22762	1

IP 54 - #IK 09

5077 35	4 way	8+12	21258	1
5077 36	6 way	8+18	23386	1
5077 37	8 way	8+24	25570	1
5077 38	12 way	8+36	34074	1

Ekinox³ TPN DB-VTPN DPX³ 160 MCCB DB's

- As per IEC 61439-3
- Suitable for Flush Mounting and Surface Mounting
- With 250 A Copper Busbar for each phase
- With 2 Neutral bar, 2 Earthbar and Cable ties for Cable management
- Fully insulated busbar & shrouded Neutral bars
- Improved Pan assembly for ease of installation
- Prefitted masking sheet
- Reversible Door for IP 43 & IP 54 DB's
- With provision for DPX³ 160 MCCB as incomer and SP/TP MCB's as outgoing

IP 30 - #IK 08

5077 40	4 way	DPX ³ 160+12	10870	1
5077 41	6 way	DPX ³ 160+18	11740	1
5077 42	8 way	DPX ³ 160+24	12864	1
5077 43	12 way	DPX ³ 160+36	19448	1

IP 43 - #IK 09 with metal door

5077 45	4 way	DPX ³ 160+12	11940	1
5077 46	6 way	DPX ³ 160+18	13566	1
5077 47	8 way	DPX ³ 160+24	14930	1
5077 48	12 way	DPX ³ 160+36	19966	1

* MRP - Maximum Retail Price Inclusive of all taxes including GST.

#IK - Refer pg - 57 for ready reckoner table.

Ekinox³ TPN DB-VTPN

DPX³ 160 MCCB DB's

Cat.Nos	Number of ways	No. of modules	MRP* ₹ / Unit	Pack
---------	----------------	----------------	------------------	------

IP 54 - #IK 09

5077 50	4 way	DPX ³ 160+12	24462	1
5077 51	6 way	DPX ³ 160+18	28130	1
5077 52	8 way	DPX ³ 160+24	29406	1
5077 53	12 way	DPX ³ 160+36	39490	1

Ekinox³ TPN DB-VTPN

DPX³ 250 MCCB DB's

- As per IEC 61439-3
- Suitable for Flush Mounting and Surface Mounting
- With 250 A Copper Busbar for each phase
- With 2 Neutral bar, 2 Earthbar and Cable ties for Cable management
- Fully insulated busbar & shrouded Neutral bars
- Improved Pan assembly for ease of installation
- Prefitted masking sheet
- Reversible Door for IP 43 & IP 54 DB's
- With provision for DPX³ 250 MCCB as incomer and SP/TP MCB's as outgoing

IP 30 - #IK 08

5077 55	4 way	DPX ³ 250+12	19800	1
5077 56	8 way	DPX ³ 250+24	21256	1
5077 57	12 way	DPX ³ 250+36	23690	1

IP 43 - #IK 09 with metal door

5077 58	4 way	DPX ³ 250+12	22104	1
5077 59	8 way	DPX ³ 250+24	25810	1
5077 60	12 way	DPX ³ 250+36	27204	1

IP 54 - #IK 09

5077 61	4 way	DPX ³ 250+12	34490	1
5077 62	8 way	DPX ³ 250+24	38952	1
5077 63	12 way	DPX ³ 250+36	45610	1

Ekinox³ TPN DB-Phase selector DB's for DX³ MCB, Isolator, RCCB and RCBO

- As per IEC 61439-3
- With inbuilt 3 nos of 63 A Phase selector switches and 3 Nos Piano Switches
- Suitable for Flush Mounting and Surface Mounting
- With 100 A Copper Busbar for each phase
- With Neutral bar, Earthbar and Cable ties for Cable management
- Fully insulated busbar & shrouded Neutral bars
- With provision for FP MCB/Isolator/RCCB/RCBO as incomer and SP MCB's as outgoing
- Supplied with wire set

IP 30 - #IK 08

5077 70	4 way	8+12	13046	1
5077 71	6 way	8+18	13876	1
5077 72	8 way	8+24	15372	1
5077 73	12 way	8+36	17024	1

IP 43 - #IK 09 with metal door

5077 80	4 way	8+12	14110	1
5077 81	6 way	8+18	14336	1
5077 82	8 way	8+24	15360	1
5077 83	12 way	8+36	17292	1

Bold Cat.Nos are products normally available with Legrand (India) Stockists. Cat.Nos that are not bold - delivery within 4 - 8 weeks from the date of order. Bold packing quantity is our mandatory packing. Orders to be placed by Legrand (India) Stockist in multiples of the same.

Ekinox³ TPN DB - 7 segment DB's for DX³ MCB, Isolator, RCCB and RCBO

Cat.Nos	Number of ways	No. of modules	MRP* ₹ / Unit	Pack
---------	----------------	----------------	------------------	------

- As per IEC 61439-3
- Separate compartment for incomer, sub-incomer & outgoing devices
- Suitable for Flush Mounting and Surface Mounting
- With 100 A Copper Busbar for each phase
- With Neutral bar, Earthbar and Cable ties for Cable management
- Fully insulated busbar & shrouded Neutral bars
- With provision for FP MCB/Isolator/RCCB/RCBO as incomer, DP RCCB/RCBO as sub incomer and SP MCB's as outgoing
- Supplied with wire set
- DB with phase segmentation and separation between incomer and outgoing

IP 30 - #IK 08

5078 80	4 way	8+12+12	9560	1
5078 81	6 way	8+12+18	10278	1
5078 82	8 way	8+12+24	11168	1
5078 83	12 way	8+12+36	12854	1

IP 43 - #IK 09 with metal door

5078 85	4 way	8+12+12	10540	1
5078 86	6 way	8+12+18	11872	1
5078 87	8 way	8+12+24	13256	1
5078 88	12 way	8+12+36	16482	1

Ekinox³ TPN DB - 7 segment DB's for 160 A DPX³ MCCB

- As per IEC 61439-3
- DB with phase segmentation and separation between incomer and Outgoing
- Suitable for Flush Mounting and Surface Mounting
- With 100 A Copper Busbar for each phase
- With Neutral bar, Earthbar and Cable ties for Cable management
- Fully Color Shrouded Insulated bus bar and Neutral bars
- With provision for DPX³ 160 MCCB as incomer DP MCB/Isolator/RCCB/RCBO as sub incomers and SP MCB's as outgoing
- Supplied with wire set

IP 30 - #IK 08

5078 90	4 way	DPX ³ 160+12+12	13664	1
5078 91	6 way	DPX ³ 160+12+18	15720	1
5078 92	8 way	DPX ³ 160+12+24	18066	1
5078 93	12 way	DPX ³ 160+12+36	20974	1

* MRP - Maximum Retail Price Inclusive of all taxes including GST.
#IK - Refer pg - 57 for ready reckoner table.

Ekinox³ TPN DB - 7 segment DB's for 160 A DPX³ MCCB

Cat.Nos	Number of ways	No. of modules	MRP* ₹ / Unit	Pack
---------	----------------	----------------	------------------	------

IP 43 - #IK 09 with metal door

5078 95	4 way	DPX ³ 160+12+12	15046	1
5078 96	6 way	DPX ³ 160+12+18	17222	1
5078 97	8 way	DPX ³ 160+12+24	19718	1
5078 98	12 way	DPX ³ 160+12+36	22460	1

Ekinox³ Metra plug & socket DB's for DX³ MCB, RCCB and RCBO

Cat.Nos	Description	No. of modules	MRP* ₹ / Unit	Pack
---------	-------------	----------------	------------------	------

- As per IEC 61439-3
- Suitable for Flush Mounting and Surface Mounting
- Suitable for protection of appliances like AC/Geyser etc
- Supplied with Neutral Links
- With provision for mounting modular devices

#IK 08

5078 10	10 A SP, 2P+E	1	1626	1
5078 11	20 A SP, 2P+E	1	1750	1
5078 14	20 A DP, 2P+E	2	1902	1
5078 17	20 A TP, 3P+E	3	3226	1
5078 18	32 A TP, 3P+E	3	3826	1
5078 20	20 A DP RCBO, 2P+E	4	1842	1
5078 21	20 A FP RCBO, 2P+E	8	3220	1
5078 22	32 A FP RCBO, 3P+E	8	3796	1

Ekinox³ P-17 Tempra plug & socket DB's for DX³ MCB, RCCB and RCBO

- As per IEC 61439-3
- Suitable for Flush Mounting and Surface Mounting
- Supplied with Neutral Links
- With provision for mounting modular devices

#IK 08

5078 60	16 A 2P+E-DP	2	2684	1
5078 63	32 A 2P+E-DP	2	2896	1
5078 61	32 A 3P+E-FP	8	4058	1
5078 62	32 A 3P+N+E-FP	8	5276	1
5078 64	63 A 3P+N+E-FP	8	13418	1

Bold Cat.Nos are products normally available with Legrand (India) Stockists.
Cat.Nos that are not bold - delivery within 4 - 8 weeks from the date of order.
Bold packing quantity is our mandatory packing. Orders to be placed by Legrand (India) Stockist in multiples of the same.

Ekinox³ Metal enclosures

for DX³ MCB, RCCB, RCBO and DPX³ MCCB's

Cat.Nos	Description	No. of modules	MRP* ₹ / Unit	Pack
---------	-------------	----------------	---------------	------

- As per IEC 61439-3
- For independent mounting of DX³ MCB, RCCB, RCBO, DPX³ 160, DPX³ 250, DPX³ 630 & DRX MCCB's
- #IK 08

#IK 08

5077 90	SP enclosure	1	436	1
5077 91	DP enclosure	2	636	1
5077 92	TP enclosure	3	636	1
5077 93	FP enclosure	4	636	1
5077 94	FP RCBO enclosure	8	1076	1

Metal one way enclosures for MCCB

5078 01	DPX ³ 160 MCCB enclosure	3&4	3654	1
5078 02	DPX ³ 250 MCCB enclosure	3&4	6490	1
5078 04	DPX ³ 630 MCCB enclosure	3&4	9838	1
5078 05	DRX 100 MCCB enclosure-TP	3&4	1952	1

Ekinox³ cable end box

Cat.Nos	Description	MRP* ₹ / Unit	Pack
---------	-------------	---------------	------

- Useful for keeping extra cables
- Possible to mount on the top or bottom of the DB
- Provision for mounting terminal blocks
- Can be used as a terminal box adaptor also

For IP 30 DB's

5079 10	For SPN 4 W IP30	620	1
5079 12	For SPN 8 W IP30	720	1
5079 14	For SPN 12 W/ VTPN/Flexy	798	1
5079 16	For SPN 16 W/ ETPN 6 way DB	1124	1
5079 25	For ETPN 8 way DB	2010	1
5079 27	For ETPN 12 way DB	2678	1
5079 29	For ETPN 16 way DB	2678	1
5079 31	For ETPN 18 way DB	2944	1
5079 33	For ETPN 20 way DB	2944	1
5079 35	For ETPN 4 way VTPN/FLEXY MCB	798	1
5079 37	For all VTPN MCCB DBs	2960	1

For IP 43 DB's

5079 11	For SPN 4 way DB	720	1
5079 13	For SPN 8 way DB	830	1
5079 15	For SPN 12 way/ VTPN/Flexy DB	930	1

* MRP - Maximum Retail Price Inclusive of all taxes including GST.

#IK - Refer pg - 57 for ready reckoner table.

Ekinox³ cable end box

Cat.Nos	Description	MRP* ₹ / Unit	Pack
---------	-------------	---------------	------

For IP 43 DB's

5079 17	For SPN 16 way/ ETPN 6 way DB	1318	1
5079 18	For SPN 18 way DB	1348	1
5079 19	For SPN 20/ETPN 8 way DB	1380	1
5079 28	For ETPN 12 way DB	3076	1
5079 30	For ETPN 16 way DB	3076	1
5079 32	For ETPN 18 way DB	3380	1
5079 34	For ETPN 20 way DB	3380	1
5079 36	For all ETPN 4W/VTPN/Flexy MCB	930	1
5079 38	For all VTPN MCCB DBs	3332	1
5079 00	For 7 segment 4 way DB	3228	1
5079 01	For 7 segment 6 way DB	3540	1
5079 02	For 7 segment 8 way DB	3950	1
5079 03	For 7 segment 12 way DB	4462	1

Ekinox³ DBs

meter box

- Suitable for Mounting DX³ Metering products
- Possible to mount on the top or bottom of the DB
- Provision for mounting Ammeter/Voltmeter/ASS/VSS
- #IK09

Provision for mounting meters

5079 40	For VTPN MCB INCOM IP 30	4030	1
5079 41	For VTPN MCB INCOM IP 43	4838	1
5079 42	For VTPN MCCB INCOM IP 30	4480	1
5079 43	For VTPN MCCB INCOM IP 43	5374	1

Per phase Isolation kit

5079 44	PPI conversion kit for ETPN 4 way DB	2314	1
5079 45	PPI conversion kit for ETPN 6 way DB	2608	1
5079 46	PPI conversion kit for ETPN 8 way DB	3018	1
5079 47	PPI conversion kit for ETPN 12 way DB	3364	1
5079 48	PPI conversion kit for ETPN 16 way DB	3778	1

Panel locks

5079 52	Panel knob for IP 43	262	1
5079 51	Panel knob with key	552	1

Bold Cat.Nos are products normally available with Legrand (India) Stockists. Cat.Nos that are not bold - delivery within 4 - 8 weeks from the date of order. Bold packing quantity is our mandatory packing. Orders to be placed by Legrand (India) Stockist in multiples of the same.

Ekinox™ distribution boards

Cat.Nos	Number of ways	MRP* ₹ / Unit	Pack
---------	----------------	---------------	------

Plexo³ boxes for DX³

Self-extinguishing: resistance to incandescent wire 650 °C
 Conform to EN 60439-3
 Weatherproof cabinets - IP 65 - IK 09 - Class II
 Door and cabinet fully reversible
 Removable chassis and faceplates from 2-row versions up
 2-position rail for modular products and moulded cases
 Spacing between rails 150 mm
 Box colour light grey L750A, cover colour dark grey R746A



6019 94

6019 32	2 (+1) Module	1582	1
6019 94	4 Module	1686	1
6019 96	6 Module	1932	1
6019 98	8 Module	2416	1

Cabinets with 12 modules per row



6018 32

6018 31	1 row 12 modules	3806	1
6018 32	2 rows 24 modules	5278	1
6018 33	3 rows 36 modules	7356	1

Cabinets with 18 modules per row

6018 35	18 modules x 1 row	4694	1
6018 36	18 modules x 2 rows	8116	1
6018 37	18 modules x 3 rows	11416	1
6018 38	18 modules x 4 rows	17762	1

Multifunction sleeves for P17



6018 32 + 0019 17

0019 17	For 2 row cabinets	3046	1
0019 18	For 3 row cabinets	4568	1
0019 67	Joining kit	888	1

Ekinox³

Mivan Construction compatible Ekinox³ DB



SALIENT FEATURES

- Slimmest DB with 71 mm depth
- Increased sheet thickness to withstand Mivan Construction challenges
- IP 43 degree of protection
- Full proof solution
- Wire set, Din rail components, Neutral and Earth bar packed separately in inner assembly set
- Plain look with rounded corners
- Innovative door knob
- Stronger glanding plates
- Door separately packed
- Easily removable knock outs for cable glanding
- Nut inserts for longer installation life
- Integrated door earthing system

* MRP - Maximum Retail Price Inclusive of all taxes including GST.
 Refer instruction manual for MIVAN (Aluminum shuttering) compatible DB's

Distribution boards

Cat.Nos	No. of devices connected	No. of 17.5 mm modules	MRP* ₹ / Unit	Pack
---------	--------------------------	------------------------	---------------	------

Supply busbars - insulated

100 A copper

Pin type

SP I/C & SP O/G

4049 26	13	13	308	1
4049 37	57	57	1194	1

SPN I/C & SPN O/G

4049 38	6	12	542	1
4049 39	28	56	2234	1

TPN I/C & SPN O/G

4049 40	5	12	560	3/30
4049 41	27	56	5460	5/10

TP I/C & TP O/G

4049 42	4	12	560	1
4049 43	19	57	5514	1

FP I/C & FP O/G

4049 44	3	12	1346	3/30
4049 45	14	56	5460	5/10

Fork type

SP I/C & SP O/G

4049 11	13	12	308	1
4049 12	57	57	1172	1

SPN I/C & SPN O/G250

4049 14	28	56	2234	1
---------	----	----	------	---

TP I/C & TP O/G

4049 17	4	12	560	1
4049 18	19	57	5460	1

FP I/C & FP O/G

4049 20	14	56	5460	5/10
---------	----	----	------	------

Cat.Nos	Description	MRP* ₹ / Unit	Pack
---------	-------------	---------------	------

Accessories for fork and pin type busbars

4049 89	End caps for SP	8	6
4049 90	End caps for DP & TP	34	6
4049 91	End caps for FP	68	20/840

Cat.Nos	Number of ways	MRP* ₹ / Unit	Pack
---------	----------------	---------------	------

Blanking plates

6014 70	-	14	10
---------	---	----	----

Bold Cat.Nos are products normally available with Legrand (India) Stockists.
 Cat.Nos that are not bold - delivery within 4 - 8 weeks from the date of order.
 Bold packing quantity is our mandatory packing. Orders to be placed by Legrand (India) Stockist in multiples of the same.

Ekinox³

For converting ETPN DB to PPI DB

PPI DB IP 30 - IK 08

No. of ways	Combine		No. of modules
	ETPN DB	PPI Kit	
4 way	4 way 507660	4 way kit 507944	8+12
6 way	6 way 507661	6 way kit 507945	8+18
8 way	8 way 507662	8 way kit 507946	8+24
12 way	12 way 507663	12 way kit 507947	8+36
16 way	16 way 507664	16 way kit 507948	8+48

PPI DB IP 43 - IK 09 with metal door

No. of ways	Combine		No. of modules
	ETPN DB	PPI Kit	
4 way	4 way 507670	4 way kit 507944	8+12
6 way	6 way 507671	6 way kit 507945	8+18
8 way	8 way 507672	8 way kit 507946	8+24
12 way	12 way 507673	12 way kit 507947	8+36
16 way	16 way 507674	16 way kit 507948	8+48

PPI DB IP 43 - IK 09 with acrylic door

No. of ways	Combine		No. of modules
	ETPN DB	PPI Kit	
4 way	4 way 507680	4 way kit 507944	8+12
6 way	6 way 507681	6 way kit 507945	8+18
8 way	8 way 507682	8 way kit 507946	8+24
12 way	12 way 507683	12 way kit 507947	8+36
16 way	16 way 507684	16 way kit 507948	8+48

PPI DB IP 54 - IK 09

No. of ways	Combine		No. of modules
	ETPN DB	PPI Kit	
4 way	4 way 507690	4 way kit 507944	8+12
6 way	6 way 507691	6 way kit 507945	8+18
8 way	8 way 507692	8 way kit 507946	8+24
12 way	12 way 507693	12 way kit 507947	8+36
16 way	16 way 507694	16 way kit 507948	8+48

IK

Protection against mechanical impact: protection index - IK

According to standard:

IEC 62262, BS EN 62262 and NF EN 62262

• This table can be used to ascertain the resistance of a product to an impact given in Joules from the IK code (graduated from 00 to 10)

It can also be used to ascertain the correspondence with the old IP code 3rd digit and the corresponding external "Ag" conditions

IK	Tests	Impact energy (in Joules)	"AG" of NF C 15-100
IK 00		0	
IK 01		0.15	
IK 02		0.2	AG1
IK 03		0.35	
IK 04		0.5	
IK 05		0.7	
IK 06		1	
IK 07		2	AG2
IK 08		5	AG3
IK 09		10	
IK 10		20	AG4

IPXX

Index of protection

IP*** index of protection of enclosures of electrical equipment in accordance with standards IEC 529, BS 5490, DIN 400 50 and NF C 20-010

Up to 1000 V± and 1500 V= (standard UTE C 20 010)

1st figure:- protection against solid bodies

IP	tests	
0		No protection
1		Protected against solid bodies larger than 50 mm (eg:- accidental contact with the hand)
2		Protected against solid bodies larger than 12 mm (eg:- finger)
3		Protected against solid bodies larger than 2.5 mm (eg:- tools, wires)
4		Protected against solid bodies larger than 1 mm (eg:- fine tools and small wires)
5		Protected against dust (no harmful deposit)
6		Completely protected against dust

2nd figure:- protection against liquids

IP	tests	
0		No protection
1		Protected against vertically-falling drops of water (condensation)
2		Protected against drops of water falling at up to 15° from the vertical
3		Protected against drops of rain water at up to 60° from the vertical
4		Protected against projections of water from all directions
5		Protected against jets of water from all directions
6		Protected against jets of water of similar force to heavy seas
7		Protected against the effects of immersion
8		Protected against prolonged effects of immersion under pressure

The contents of all the above charts are for guidance only, if you have any doubt as to the interpretation of the information contained therein, please refer either to the standard itself or contact Legrand.

In accordance with our policy of continuous improvement, Legrand reserves the right to change specifications and designs without notice. All information given here is correct at the time of going to press.

Arteor™ is the innovative answer to the increasingly complex requirements in the building business all over the world. Arteor™ excels by its unique aesthetics and a rich choice of innovative designs and ergonomical options.



The range extends from wiring devices, through innovative radio automation solutions, up to fully networked home automation systems based on BUS technology, which can also be integrated into third party solutions.

Arteor™

versatility and a global vision for any installation level



Design options for control functions

Arteor™ offers a wide choice of ergonomics and finishes to satisfy the most demanding customers. All stand-alone control functions are available in two shapes of rockers – round or square – and in three colours – white, magnesium and champagne.



Round rocker White



Round rocker Magnesium



Square rocker White



Square rocker Magnesium



Arteor™ design for a global lifestyle

The timeless design of Arteor™ features clearly hi-tech characteristics understandable anywhere in the world. Minimalist and sober, its carefully crafted design is inspired by the most modern technological devices, such as flat screens and digital photo frames, creating the impression that the product is floating on the wall.

Round rocker Champagne



Square rocker Champagne



Switch & socket

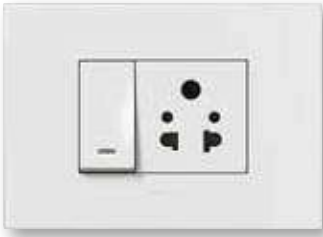

Bell push



Fan regulator



TV socket



1-way switch - 3 gang



Skirting light



Power unit



Villas



6AX switch



Leading \ trailing edge dimmer



Triple RCA socket



Homes



Arteor™

the ideal solution,
always and
everywhere

Its versatility makes Arteor™ the ideal choice for every kind of project, anywhere in the world at any installation level. Arteor™ suits any requirement in terms of design and function for every kind of building, from residential to commercial.

Skirting light



USB charger



Automatic switch



6 A 1 way switch



HDMI



USB



Electronic touch dimmer



RJ45



Female HD15 + Jack



Universal dimmer



Hotels



4-Scenario touch control



S-Video socket



Keycard switch



External unit



Internal unit



TV/R/SAT



Offices



Arteor™ office and hotel solutions

Desk and
entrance light



Bed light and
curtain switch



Data sockets





MY HOME
 legrand

The answer for all home automation requirements,
from a single function to global integrated solutions.
My Home Legrand supports 2 technologies :
Radio using ZigBee® protocol and BUS using SCS protocol.

* for more details contact us

Arteor™ home automation overview

This comprehensive and versatile home automation solution, which is integrated to the Arteor™ line will satisfy your most demanding customers' needs



NEUTRAL



MIRROR



GRAPHIC



BRUSHED METAL



WOOD



SIGNATURE





Arteor™

a rich choice of finishes

A wide range of finishes and materials for perfect harmony with modern environments, whether residential or commercial.

Features that set ARTEOR™ apart



- ① Finger-proof terminals for IP 20 protection against accidental contact.
- ② Captive "never to loose screws".



- ① Tunnel terminals preventing screwdrivers from slipping.
- ② Laser marking on mechanisms. Arrow showing the correct orientation of the mechanism.
- ③ The latest IS 3854 : 1997.

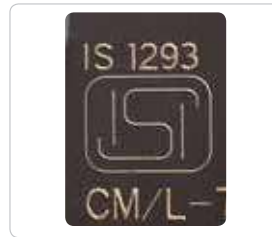

Sockets with ISI mark, conforming to IS 1293. Fan regulator with ISI mark, conforming to IS 11037.



Fully shrouded internal mechanism under the rocker preventing visibility of sparks.



- ① Stripping templates on sockets for stripping off exact length of insulation.



Sockets are shuttered for child's safety against electric shocks.



Possibility of weather proofing mechanisms using Plexo IP 55 and IP 66 boxes.



For switches with LED lamps, life of LED is 50000 burning hours. Consumes power (0.76 W) next to NIL.

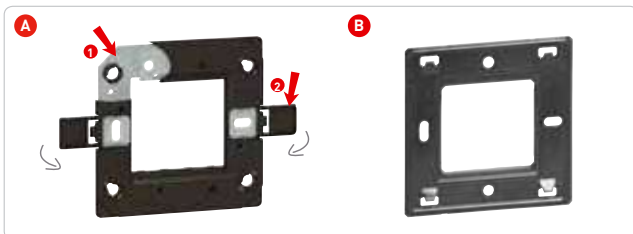

A. For all high end plates

- ① Metal frame providing solid support to base. Bi-material frame - electrical safety IP20.
- ② Screw caps can be closed once the support frame is installed, ensuring total insulation.

B. For white plates only.



2x2 way switch - 3 controls possible in 2 module plate. In round and square design possible.



Mechanisms compatible with DLP trunking systems, columns, floor boxes and VDI installations.

Protection at every step of the installation process



Support frames and plates are each supplied with special shrink wrap protection should be removed only once site work is fully completed.

Arteor™

versatility and modularity for unrivalled flexibility

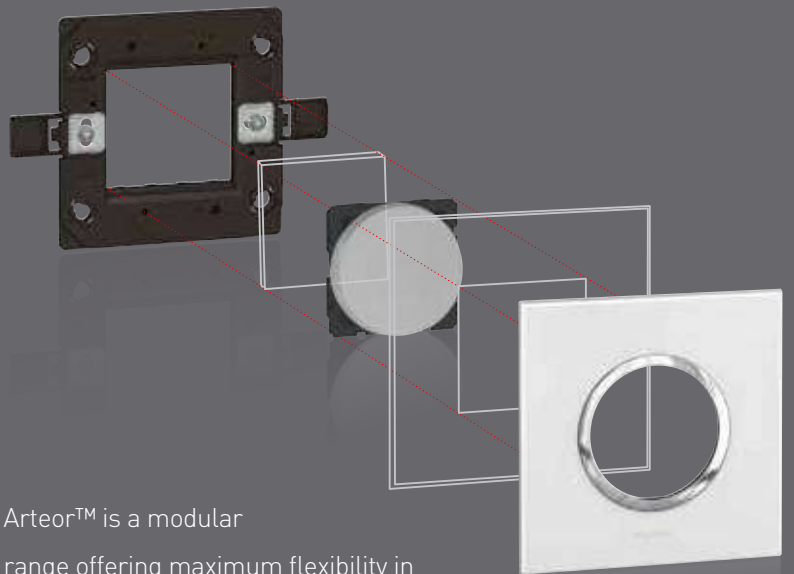

Arteor™ is a modular range offering maximum flexibility in terms of installation and configuration.

Arteor™ square - white mechanisms

Cat.Nos	Description	MRP* ₹ / Unit	Pack
---------	-------------	------------------	------

Switches – 6 A - 250 V AC

5734 00	Switch - 6 A - SP - 1 way 1 module	170	20/200
5734 01	Switch - 6 A - SP - 1 way with indicator - 1 module	262	20/200
5734 02	Switch - 6 A - SP - 2 way 1 module	232	20/200
5734 03	Switch - 6 A - SP - 2 way with indicator - 1 module	330	20/200

Switches – 10 A - 250 V AC

5734 50	Switch - 10 A - SP - 1 way 2 module	270	10/100
5734 51	Switch - 10 A - SP - 2 way 2 module	318	10/100
5720 37	Switch - 10 A - SP - 2 way with indicator & label holder - 2 module	1510	10/100
5720 38	Intermediate switch - 2 module	1804	10/100

Switches – 20 A - 250 V AC

5734 10	Switch - 20 A - SP - 1 way - 1 module	306	20/200
5734 52	Switch - 20 A - SP - 1 way - 2 module	366	10/100
5720 63	Switch - 20 A - SP - 1 way with indicator - 1 module	316	20/200
5734 11	Switch - 20 A - SP - 2 way with indicator - 1 module	442	20/200
5720 42	Switch - 20 A - SP - 2 way with indicator - 2 module	482	10/100
5720 43	Switch - 20 A - 3 gang - 1 way - 2 module	866	10/100
5720 44	Switch - 20 A - 3 gang - 2x2 way + 1x1 way - 2 module	948	10/100
5734 54	Switch - 20 A - DP - 1 way with indicator - 2 module	680	10/100
5720 49	Switch - 20 A - DP - 1 way with indicator and water heater marking - 2 module	716	10/100

Accessory for switch with indicator

5738 06	LED for switch with indicator (blue)	54	5/50
5738 05	LED for switch with indicator (red)	46	5/50

Switches – 25 A - 230 V AC

5734 17	25 A switch with indicator	412	20/200
---------	----------------------------	-----	--------

Switches – 32 A / 40 A - 250 V AC

5734 12	Switch - 32 A - DP - 1 way with indicator - 2 module	972	10/100
5735 30	Switch - 40 A - DP - 1 way with indicator - fits on 1/2 module box	1124	1/5/20

Push button – 6 A - 250 V AC

5734 13	Bell push - 6 A - SP - 1 way - 1 module	248	20/200
5734 59	Bell push - 6 A - SP - 1 way - 2 module	348	10/100
5734 04	Push button - 6 A - SP - 1 way - 1 module	262	20/200

* MRP - Maximum Retail Price Inclusive of all taxes including GST.
 ■ Price available on request

Arteor™ square - white mechanisms

Cat.Nos	Description	MRP* ₹ / Unit	Pack
---------	-------------	------------------	------

Push button – 6 A - 250 V AC

5734 05	Push button - 6 A-SP - 1 way with indicator - 1 module	332	20/200
5734 14	Bell push - 6 A-SP - 1 way with indicator - 1 module	330	20/200
5734 60	Bell push - 6 A-SP - 1 way with indicator - 2 module	468	10/100

Electric roller blinds control

5722 20	Double switch for electric shutter - 2 module	608	10/100
---------	---	-----	--------

Dimmers and fan regulators

5734 62	Light dimmer 60 to 400 watts - 2 module	1002	10/100
5734 16	Fan step regulator 100 watts - 1 module	804	1/5/50
5734 63	Fan step regulator 100 watts - 2 module	992	1/10/100
5734 69	Fan step regulator 120 watts - 2 module (for 48 & 56" fans)	1060	1/10/100
5734 68	Fan step regulator - 2 module for energy saving fans	1056	1/10/100

Electronic dimmers

5734 65	Universal touch dimmer 3 M	6290	1/10
5722 39	Universal dimmer without neutral 400 W - 2 module	■	1/10

Indian standard sockets

5734 70	Socket shuttered - 6 A - 2/3 pin - universal India 2 module	302	20/200
5734 71	Socket shuttered - 6/16 A - 3 pin - Indian - 2 module	402	10/100
5734 67	Socket shuttered - 6/16 A - 3 pin - Indian - 3 module	486	5/50
5734 72	Socket - 13 A - 3 pin - 2P+E BS - 2 module	630	10/100
5735 10	Socket with switch - 16 A - 3 pin - 2P+E - Indian - 3 module	1140	5/50
5721 04	Socket - 15/16 A - 2P - Euro/US - 1 module	328	10/100
5737 79	Socket - 6 A/13 A/15 A for 127 V, - double multistandard - 4 module	700	5/50
5734 73	Multistandard socket - 6/10/13 A - 2/3 pin for 250 V AC, 15 A for 127 V type - 2 pin - 2 module	382	10/100
5734 66	25 A socket - 2 module	492	10/100
5721 16	Euro/US - 15 A-127 V/16 A - 250 V, 2P + E with shutter 2 module	566	10/100

Energy plugs

5738 86	6 A plug	120	1/10/100
5738 88	16 A plug	160	1/10/100
5738 07	25 A plug	184	1/10/100

Bold Cat.Nos are products normally available with Legrand (India) Stockists.
 Cat.Nos that are not bold - delivery within 4 - 8 weeks from the date of order.
 Bold packing quantity is our mandatory packing. Orders to be placed by
 Legrand (India) Stockist in multiples of the same.

Arteor™ square - white mechanisms

Cat.Nos	Description	MRP* ₹ / Unit	Pack
---------	-------------	------------------	------

USB chargers (IS13252 (Part 1) / IEC 60950-1)

5734 21	USB Charger 1 M 1000 mA	1324	1/5/50
5734 22	Double USB Charger 2 M 2400 mA	2110	1/10/100

RJ 11 telephone sockets (Jack type)

5734 27	Telephone socket - double RJ11 - 1 module	358	20/200
5734 26	Telephone socket - RJ11 with shutter - 1 module	208	20/200

Information outlets - toolless

5734 29	Information socket - category 5e-UTP - 1 module	494	20/200
5734 75	Information socket - category 5e-UTP - 2 module	528	10/100
5734 28	Information socket - category 6-UTP - 1 module	758	20/200
5734 74	Information socket - category 6-UTP - 2 module	796	10/100

TV sockets

5734 25	TV Co-Axial socket - 1 module	216	20/200
---------	----------------------------------	-----	--------

Electronic chime

5734 43	Bell ding dong 230V - 2 module	330	1/10/100
---------	-----------------------------------	-----	----------

Buzzer

5734 42	Buzzer - 230 V - 1 module	1170	20/200
---------	------------------------------	------	--------

Bell call indicator & register - 6A - 250V AC

5734 15	Bell call indicator with register - 6 A - 1 way - SP - 1 module	1462	20/200
5736 06	Set of labels for bell call indicator (1-20)	384	5/50

Lighting

5734 64	Skirting light with LED - 230 V - 3 module	788	1/5/25
5722 26	Skirting light with detector (LED) - 230 V - 2 module	14210	1/20
5722 34	Miniature emergency skirting light unit - 2 module	7940	1/20
5724 53	Over door light unit (Red) 2 module	440	10/100
5722 23	Over door light unit (White) 2 module	360	10/100
5724 52	Indicator unit with transparent LED with coloured labels - 1 module	588	10/100

Power strip and power units

5737 80	Set of 3 multistandard socket + Switch pre-wired - 8 module	2042	1/10
5735 42 ⁽¹⁾	1 Power unit (AC & Geyser) 16 A - 4 module	1294	1/5
5721 54	Power unit (AC & Geyser) 32 A (with cable output)	1456	1/5

* MRP - Maximum Retail Price Inclusive of all taxes including GST.
(1) Supplied with white plate
■ Price available on request

Arteor™ square - white mechanisms

Cat.Nos	Description	MRP* ₹ / Unit	Pack
---------	-------------	------------------	------

MCB

5723 61	MCB - 16 A-SPN - 2 module	3344	1
---------	------------------------------	------	---

RCBO

5734 85	RCBO - 16 A-SPN - 2 module	11406	1
---------	----------------------------	-------	---

Protectors

5734 40	Surge protector - 1 module	3482	20/200
5734 48	Surge protector - 2 module	4070	10/100

Hotel "DND and MMR" functions

5734 61	DND and MMR indicator with bell push 1+1 module	1572	5/50
5734 58	Internal control unit for DND & MMR 1+1 module	1130	10/100

Hotel keycard switch

5722 44	16 A key card switch 230 V 2 module	4296	1/20
5722 59	Key fob for above	1170	10/50

Shaver socket

5721 53	Shaver socket 230 V / 120 - 230 V with earth connector	4468	1
---------	--	------	---

Infrared sensors

5740 47	PIR sensor with neutral 2 module	7376	1/20
5740 09	PIR sensor without neutral - 2 module	6182	1/20

Time switch

5720 55	Time delay switch 2 module	5644	1/20
---------	----------------------------	------	------

Audio-video sockets

5722 72	Double RCA socket (audio) 1 module	■	1/20
5722 73	Triple RCA socket (audio & video) 1 module	■	1/20
5722 74	Female 3.5 mm Jack - 1 module	■	1/20
5722 76	Female BNC 75 jack - 1 module	■	1/20
5722 83	Female XLR jack - 2 module	■	1/20
5723 70	Kit HD 15 + jack amplified transceiver	■	1
5720 97	Preterminated sockets Female HD15 - 1 module	■	1
5720 96	Preterminated sockets HDMI 1.4 - 1 module	■	1
5722 84	Line dying down 100 V (25-30W) 2 module	■	1
5722 77	Male XLR jack 2 module	■	1/20
5722 78	Female 3.5 mm Jack - solder - 1 module	■	1/20
5722 75	USB socket - 1 module	■	1/20
5744 01	S-VIDEO socket - 1 module	■	1/40

Bold Cat.Nos are products normally available with Legrand (India) Stockists.
Cat.Nos that are not bold - delivery within 4 - 8 weeks from the date of order.
Bold packing quantity is our mandatory packing. Orders to be placed by
Legrand (India) Stockist in multiples of the same.

Arteor™ square - white mechanisms

Cat.Nos	Description	MRP* ₹ / Unit	Pack
---------	-------------	------------------	------

Audio-video sockets

5722 88	Female HD15 + Jack 3.5 mm - 2 module	■	1/20
---------	---	---	------

Cable outlet

5734 80	45 A cable outlet 2 module	878	5/50
5734 33	Cord outlet with 8 mm diameter - 1 module	278	20/200
5734 79	Standard cord outlet - 2 module	400	10/100

Blanking plate

5734 49	1 module blank	44	20/200
5723 44	2 modules blank	64	10/100
5758 10	Blanking plate + frame - 2 module	366	10/100

Mounting accessories for panel

5760 15	Panel mounting support - 1 module	226	10/100
5760 16	Panel mounting support - 2 module	238	10/100
5760 50	DIN rail support 2 module	286	10/100

Square - magnesium mechanisms

Switches – 6 A - 250 V AC

5736 00	Switch - 6 A-SP - 1 way - 1 module	192	20/200
5736 01	Switch - 6 A-SP - 1 way with indicator - 1 module	300	20/200
5736 02	Switch - 6 A-SP - 2 way - 1 module	270	20/200
5736 03	Switch - 6 A-SP - 2 way with indicator - 1 module	384	20/200

Switches – 10 A - 250 V AC

5736 50	Switch - 10 A-SP - 1 way - 2 module	286	10/100
5736 51	Switch - 10 A-SP - 2 way - 2 module	340	10/100
5725 37	Switch - 10 A-SP - 2 way with indicator & label holder- 2 module	1698	10/100
5725 38	Intermediate switch - 2 module	2078	10/100

Switches – 20 A - 250 V AC

5736 10	Switch - 20 A-SP - 1 way 1 module	348	20/200
5736 52	Switch - 20 A-SP - 1 way 2 module	410	10/100
5725 63	Switch - 20 A-SP - 1 way with indicator -1 module	366	20/200
5736 11	Switch - 20 A-SP - 2 way with indicator -1 module	504	20/200
5725 42	Switch - 20 A-SP - 2 way with indicator - 2 module	538	10/100
5725 43	Switch - 20 A-3 gang - 1 way - 2 module	992	10/100
5725 44	Switch - 20 A-3 gang - 2x2 way + 1x1 way - 2 module	1038	10/100

* MRP - Maximum Retail Price Inclusive of all taxes including GST.
■ Price available on request

Arteor™ square - magnesium mechanisms

Cat.Nos	Description	MRP* ₹ / Unit	Pack
---------	-------------	------------------	------

Switches – 20 A - 250 V AC

5736 54	Switch 20 A-DP - 1 way with indicator - 2 module	804	10/100
5725 49	Switch - 20 A-DP - 1 way with indicator and water heater marking - 2 module	856	10/100

Switches – 25 A - 230 V AC

5736 17	25A switch with indicator	460	20/200
---------	---------------------------	-----	--------

Switches – 32 A / 40 A - 250 V AC

5736 12	Switch - 32 A-DP - 1 way with indicator - 2 module	1124	10/100
5737 30	Switch - 40 A-DP - 1 way with indicator - fits on 1/2 module box	1288	1/5/20

Push button – 6 A - 250 V AC

5736 13	Bell push - 6 A-SP- 1 way - 1 module	278	20/200
5736 59	Bell push - 6 A-SP - 1 way - 2 module	400	10/100
5736 04	Push button - 6 A-SP - 1 way -1 module	288	20/200
5736 05	Push button - 6 A-SP - 1 way with indicator - 1 module	386	20/200
5736 14	Bell push - 6 A-SP - 1 way with indicator - 1 module	384	20/200
5736 60	Bell push - 6 A-SP - 1 way with indicator - 2 module	534	10/100

Electric roller blinds control

5727 20	Double switch for electric shutter - 2 module	702	10/100
---------	--	-----	--------

Dimmers and fan regulators

5736 62	Light dimmer - 60 to 400 watts - 2 module	1158	10/100
5736 16	Fan step regulator - 100 watts - 1 module	926	1/5/50
5736 63	Fan step regulator - 100 watts - 2 module	1140	1/10/100
5736 69	Fan step regulator - 120 watts - 2 module (for 48 & 56" fans)	1220	1/10/100
5736 68	Fan step regulator - 2 module for energy saving fan	1210	1/10/100

Electronic dimmer

5727 39	Universal dimmer without neutral 400 W - 2 module	■	1/10
---------	--	---	------

Indian standard sockets

5736 70	Socket shuttered - 6 A - 2/3 pin - universal India - 2 module	352	20/200
5736 71	Socket shuttered - 6/16 A - 3 pin - Indian - 2 module	464	10/100

Bold Cat.Nos are products normally available with Legrand (India) Stockists.
Cat.Nos that are not bold - delivery within 4 - 8 weeks from the date of order.
Bold packing quantity is our mandatory packing. Orders to be placed by
Legrand (India) Stockist in multiples of the same.

Arteor™ square - magnesium mechanisms

Cat.Nos	Description	MRP* ₹ / Unit	Pack
---------	-------------	------------------	------

Indian standard sockets

5736 67	Socket shuttered - 6/16 A - 3 pin - Indian - 3 module	566	5/50
5736 72	Socket - 13 A - 3 pin - 2P+E BS - 2 module	730	10/100
5737 10	Socket with switch - 16 A - 3 pin - 2P+E - Indian 3 module	1310	5/50
5726 04	Socket - 15/16 A - 2P - Euro/US - 1 module	376	10/100
5739 79	Socket w - 6 A/13 A/15 A for 127 V, - double multistandard - 4 module	802	5/50
5736 73	Multistandard socket - 6/10/13 A - 2/3 pin for 250 V AC 15 A for 127 V type - 2 pin 2 module	430	10/100
5736 66	25 A socket - 2 module	564	10/100
5726 16	Euro/US 15 A-127 VA/16 A 230 V 2P+E with shutter 2 M	672	10/100

USB chargers (IS13252 (Part 1) / IEC 60950-1)

5736 21	USB Charger 1M 1000mA	1528	1/5/50
5736 22	Double USB Charger 2M 2400mA	2426	1/10/100

RJ 11 telephone sockets (Jack type)

5736 27	Telephone socket - double RJ11 - 1 module	412	20/200
5736 26	Telephone socket - RJ11 with shutter - 1 module	250	20/200

Information outlets - toolless

5736 29	Information socket - category 5e - UTP - 1 module	566	20/200
5736 75	Information socket - category 5e - UTP - 2 module	608	10/100
5736 28	Information socket - category 6 - UTP - 1 module	862	20/200
5736 74	Information socket - category 6 - UTP - 2 module	908	10/100

TV sockets

5736 25	TV Co-Axial socket - 1 module	256	20/200
---------	-------------------------------	-----	--------

Electronic chime

5736 43	Bell ding dong 230 V - 2 module	352	10/100
---------	---------------------------------	-----	--------

Buzzer

5736 42	Buzzer- 230 V - 1 module	1282	20/200
---------	--------------------------	------	--------

Bell call indicator & register - 6A - 250V AC

5736 15	Bell call indicator with register - 6 A - 1 way - SP - 1 module	1688	20/200
---------	---	------	--------

Arteor™ square - magnesium mechanisms

Cat.Nos	Description	MRP* ₹ / Unit	Pack
---------	-------------	------------------	------

Lighting

5735 64	Skirting light with LED - 230 V - 3 module	906	1/5/25
5727 26	Skirting light with detector (LED) - 230 V - 2 module	16340	1/20

Power strip and power units (without plate)

5739 80	Set of 3 multistandard socket + switch pre-wired - 8 module	2344	1/10
5737 42 ⁽³⁾	Power unit (AC & Geyser) 16 A - 4 module	1504	1/5
5726 54	Power unit (AC & Geyser) 32 A (with cable output) 4 module	1708	1/5

Hotel "DND and MMR " functions

5736 61	DND and MMR indicator with bell push 1+1 module	1804	5/50
5736 58	Internal control unit for DND & MMR 1+1 module	1304	10/100

Hotel keycard switch

5727 44	16 A Key card switch 230 V with time delay - 2 module	4730	1/20
5727 59	Key fob for above	1626	10/50

Shaver socket

5726 53	Shaver socket 230 V / 120-230 V with earth connector	4918	1
---------	--	------	---

Infrared sensors

5740 97	PIR sensor with neutral - 2 module	8488	1/20
5740 59	PIR sensor without neutral - 2 module	7562	1/20

Time switch

5740 84	Time delay switch - 2 module	6244	1/20
---------	------------------------------	------	------

Audio-video sockets

5727 72	Double RCA socket (audio) - 1 module	■	1/20
5727 73	Triple RCA socket (audio & video) - 1 module	■	1/20
5727 74	Female 3.5 mm Jack - 1 module	■	1/20
5727 76	Female BNC 75 jack - 1 module	■	1/20
5727 83	Female XLR jack - 2 module	■	1/20
5728 70	Kit HD 15 + Jack Amplified transceiver - 3*4 module	■	1
5725 97	Preterminated sockets Female HD15 - 1 module	■	1

* MRP - Maximum Retail Price Inclusive of all taxes including GST.

(3) Supplied without Cover plate

(2) Supplied with Mirror Black plate

■ Price available on request.

Bold Cat.Nos are products normally available with Legrand (India) Stockists. Cat.Nos that are not bold - delivery within 4 - 8 weeks from the date of order. Bold packing quantity is our mandatory packing. Orders to be placed by Legrand (India) Stockist in multiples of the same.

Arteor™ square - magnesium mechanisms

Cat.Nos	Description	MRP* ₹ / Unit	Pack
---------	-------------	------------------	------

Audio-video sockets

5725 96	Preterminated sockets HDMI 1.4 - 1 module	■	1
5727 84	Line dying down 100 V (25-30 W) 2 module	■	1
5727 77	Male XLR jack 2 module	■	1/20
5727 78	Female 3.5 mm Jack - solder - 1 module	■	1/20
5727 75	USB socket - 1 module	■	1/20
5744 51	S-VIDEO socket - 1 module	■	1/40
5727 88	Female HD15 + Jack 3.5 mm - 2 module	■	1/20

Blanking plate

5736 49	1 module blank	44	20/200
5728 44	2 modules blank	70	10/100

Dedicated switches

5738 00	Dedicated switch - 6 A - 1 way - SP - red - 1 module	222	20/200
5738 01	Dedicated switch - 10 A - 1 way - SP - red - 1 module	224	20/200
5738 02	Dedicated switch - 20 A - 1 way - DP - red - 1 module	776	5/40

Tamper proof and dedicated sockets

5738 08	Tamperproof red Indian socket 6 A (2/3 pin) - 2 module	614	20/200
5738 10	Dedicated socket with switch - 16 A - 3 pin - 2P+E - Indian - 3 module	1608	5/50
5738 09	Insert for tamper proof Indian socket - 6 A	82	1/20/200

NEW! Square - Champagne mechanisms

Switches - 6 A - 250 V AC

5748 00	Switch - 6 A-SP - 1 way - 1 module	192	20/200
5748 01	Switch - 6 A-SP - 1 way with indicator - 1 module	300	20/200
5748 02	Switch - 6 A-SP - 2 way - 1 module	270	20/200
5748 03	Switch - 6 A-SP - 2 way with indicator - 1 module	384	20/200

Switches - 10 A - 250 V AC

5748 04	Switch - 10 A-SP - 1 way - 2 module	286	10/100
5748 05	Switch - 10 A-SP - 2 way - 2 module	340	10/100
5748 06	Switch - 10 A-SP - 2 way with indicator & label holder- 2 module	1698	10/100
5748 07	Intermediate switch - 2 module	2078	10/100

NEW!

Arteor™ square - champagne mechanisms

Cat.Nos	Description	MRP* ₹ / Unit	Pack
---------	-------------	------------------	------

Switches - 20 A - 250 V AC

5748 08	Switch - 20 A-SP - 1 way 1 module	348	20/200
5748 09	Switch - 20 A-SP - 1 way 2 module	410	10/100
5748 10	Switch - 20 A-SP - 1 way with indicator - 1 module	366	20/200
5748 11	Switch - 20 A-SP - 2 way with indicator - 1 module	504	20/200
5748 12	Switch - 20 A-SP - 2 way with indicator - 2 module	538	10/100
5748 13	Switch - 20 A-3 gang - 1 way - 2 module	992	10/100
5748 14	Switch - 20 A-3 gang - 2x2 way + 1x1 way - 2 module	1038	10/100
5748 15	Switch 20 A-DP - 1 way with indicator - 2 module	804	10/100
5748 16	Switch - 20 A-DP - 1 way with indicator and water heater marking - 2 module	856	10/100

Switches - 25 A - 230 V AC

5748 17	25A switch with indicator	460	20/200
---------	---------------------------	-----	--------

Switches - 32 A / 40 A - 250 V AC

5748 18	Switch - 32 A-DP - 1 way with indicator - 2 module	1124	10/100
5748 19	Switch - 40 A-DP - 1 way with indicator - fits on 1/2 module box	1288	1/5/20

Push button - 6 A - 250 V AC

5748 23	Bell push - 6 A-SP - 1 way - 1 module	278	20/200
5748 24	Bell push - 6 A-SP - 1 way - 2 module	400	10/100
5748 21	Push button - 6 A-SP - 1 way -1 module	288	20/200
5748 22	Push button - 6 A-SP - 1 way with indicator - 1 module	386	20/200
5748 25	Bell push - 6 A-SP - 1 way with indicator - 1 module	384	20/200
5748 26	Bell push - 6 A-SP - 1 way with indicator - 2 module	534	10/100

Electric roller blinds control

5748 20	Double switch for electric shutter - 2 module	702	10/100
---------	---	-----	--------

Dimmers and fan regulators

5748 27	Light dimmer - 60 to 400 watts - 2 module	1158	10/100
5748 29	Fan step regulator - 100 watts - 1 module	926	1/5/50
5748 30	Fan step regulator - 100 watts - 2 module	1140	1/10/100
5748 31	Fan step regulator - 120 watts - 2 module (for 48 & 56" fans)	1220	1/10/100
5748 32	Fan step regulator - 2 module for energy saving fan	1210	1/10/100

* MRP - Maximum Retail Price Inclusive of all taxes including GST.
Red Cat.Nos - new products
■ Price available on request.

Bold Cat.Nos are products normally available with Legrand (India) Stockists. Cat.Nos that are not bold - delivery within 4 - 8 weeks from the date of order. Bold packing quantity is our mandatory packing. Orders to be placed by Legrand (India) Stockist in multiples of the same.

Arteor™ square - champagne mechanisms

NEW!

Indian standard sockets

Cat.Nos	Description	MRP* ₹ / Unit	Pack
5748 33	Socket shuttered - 6 A - 2/3 pin - universal India - 2 module	352	20/200
5748 34	Socket shuttered - 6/16 A - 3 pin - Indian - 2 module	464	10/100
5748 35	Socket shuttered - 6/16 A - 3 pin - Indian - 3 module	566	5/50
5748 39	Socket w - 6 A/13 A/15 A for 127 V, - double multistandard - 4 module	802	5/50
5748 40	Multistandard socket - 6/10/13 A - 2/3 pin for 250 V AC 15 A for 127 V type - 2 pin 2 module	430	10/100
5748 41	25 A socket - 2 module	564	10/100

USB chargers (IS13252 (Part 1) / IEC 60950-1)

5748 43	USB Charger 1M 1000mA	1528	1/5/50
5748 44	Double USB Charger 2M 2400mA	2426	1/10/100

RJ 11 telephone sockets (Jack type)

5748 45	Telephone socket - double RJ11 - 1 module	412	20/200
5748 46	Telephone socket - RJ11 with shutter - 1 module	250	20/200

Information outlets - toolless

5748 47	Information socket - category 5e - UTP - 1 module	566	20/200
5748 48	Information socket - category 5e - UTP - 2 module	608	10/100
5748 49	Information socket - category 6 - UTP - 1 module	862	20/200
5748 50	Information socket - category 6 - UTP - 2 module	908	10/100

TV sockets

5748 51	TV Co-Axial socket - 1 module	256	20/200
---------	-------------------------------	-----	--------

Electronic chime

5748 52	Bell ding dong 230 V - 2 module	352	10/100
---------	---------------------------------	-----	--------

Buzzer

5748 53	Buzzer- 230 V - 1 module	1282	20/200
---------	--------------------------	------	--------

Bell call indicator & register - 6A - 250V AC

5748 54	Bell call indicator with register - 6 A - 1 way - SP - 1 module	1688	20/200
---------	---	------	--------

Lighting

5748 55	Skirting light with LED - 230 V - 3 module	906	1/5/25
---------	--	-----	--------

* MRP - Maximum Retail Price Inclusive of all taxes including GST.
Red Cat.Nos - new products

Arteor™ square - champagne mechanisms

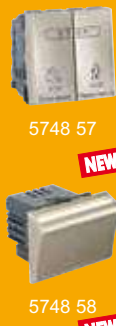
NEW!

Hotel "DND and MMR" functions

5748 56	DND and MMR indicator with bell push 1+1 module	1804	5/50
5748 57	Internal control unit for DND & MMR 1+1 module	1304	10/100

Hotel keycard switch

5748 58	16 A Key card switch 230 V with time delay - 2 module	4730	1/20
5727 59	Key fob for above	1626	10/50

Blanking plate

5748 63	1 module blank	44	20/200
5748 64	2 modules blank	70	10/100

No space to add image
572759

Round - white mechanisms

Switches - 6 A - 250 V AC

5733 00	Switch - 6 A-SP - 1 way left - 1 module	226	20/200
5733 01	Switch - 6 A-SP - 1 way right - 1 module	226	20/200
5733 12	Switch - 6 A-SP - 1 way - middle - 1 module	226	20/200
5733 05	Switch - 6 A-SP - 2 way - left - 1 module	276	20/200
5733 06	Switch - 6 A-SP - 2 way - right - 1 module	276	20/200
5733 02	Switch - 6 A-SP - 1 way with indicator - left - 1 module	316	20/200
5733 04	Switch - 6 A-SP - 1 way with indicator - right - 1 module	316	20/200
5733 03	Switch - 6 A-SP - 1 way with indicator - middle - 1 module	316	20/200
5733 07	Switch - 6 A-SP - 2 way with indicator - left - 1 module	398	20/200
5733 08	Switch - 6 A-SP - 2 way with indicator - right - 1 module	398	20/200

Switches - 20 A - 250 V AC

5733 20	Switch - 20 A-SP - 1 way - left - 1 module	370	20/200
5733 21	Switch - 20 A-SP - 1 way - right - 1 module	370	20/200
5730 21	Switch - 20 A-SP - 1 way - middle - 1 module	374	20/200
5733 40	Switch - 20 A-SP - 1 way - 2 module	430	10/100
5720 64	Switch - 20 A-SP - 1 way with indicator-left - 1 module	382	20/200
5720 65	Switch - 20 A-SP - 1 way with indicator-right - 1 module	382	20/200
5730 24	Switch - 20 A-SP - 2 way - middle - 1 module	382	20/200
5733 22	Switch - 20 A-SP - 2 way with indicator-left - 1 module	532	20/200



Bold Cat.Nos are products normally available with Legrand (India) Stockists. Cat.Nos that are not bold - delivery within 4 - 8 weeks from the date of order. Bold packing quantity is our mandatory packing. Orders to be placed by Legrand (India) Stockist in multiples of the same.

Arteor™ round - white mechanisms

Cat.Nos	Description	MRP* ₹ / Unit	Pack
---------	-------------	------------------	------

Switches – 20 A - 250 V AC

5733 23	Switch - 20 A-SP - 2 way with indicator-right-1 module	532	20/200
5730 71	Switch - 20 A-SP - 2 way with indicator - 2 module	470	10/100
5730 72	Switch - 20 A-3 gang - 1 way- 2 module	1036	10/100
5730 73	Switch - 20 A-3 gang - 2x2 way+1x1 way- 2 module	1138	10/100
5733 42	Switch 20 A-DP - 1 way with indicator- 2 module	804	10/100
5730 27	Switch - 20 A-SP- 2 way with indicator - middle - 1 module	532	20/200



5730 72



5733 26



5733 31



5733 30

Switches - 32 A

5733 26	Switch - 32 A-DP -1 way with indicator - 2 module	1168	10/100
---------	---	------	--------

Push button – 6 A- 250 V AC

5733 31	Bell push - 6 A-SP - 1 way - right - 1 module	288	20/200
5733 30	Bell push - 6 A-SP- 1 way - left - 1 module	288	20/200
5733 46	Bell push - 6 A-SP- 1 way - 2 module	412	10/100
5733 09	Push button - 6 A-SP - 1 way - left - 1 module	306	20/200
5733 11	Push button - 6 A-SP- 1 way - right - 1 module	306	20/200
5733 47	Bell push - 6 A-SP- 1 way with indicator - 2 module	560	10/100
5733 10	Push button - 6 A-SP - 1 way - middle - 1 module	306	20/200

Electric roller blinds control

5732 20	Double pole switch 10A - 2 module	732	10/100
---------	-----------------------------------	-----	--------

Dimmers and fan regulators

5730 66	Light dimmer - 60 to 400 Watts - 2 module	1210	1/10/100
5730 03	Fan step regulator - 100 Watts - 2 module	1192	1/10/100
5730 69	Fan step regulator - 120 Watts - 2 module	1290	1/10/100
5730 04	Fan step regulator - 2 module for energy saving fans	1262	1/10/100



5730 66

Electronic dimmer

5743 19	Universal dimmer without neutral 400 W - 2 module	■	1/10
---------	---	---	------



5743 19

Multistandard sockets

5734 89	Multistandard socket 6/10/13 A - 2/3 pin for 250 V AC 15 A for 127 V type - 2 pin 2 module	436	10/100
---------	--	-----	--------



5734 89

* MRP - Maximum Retail Price Inclusive of all taxes including GST.
■ Price available on request.

Arteor™ round - white mechanisms

Cat.Nos	Description	MRP* ₹ / Unit	Pack
---------	-------------	------------------	------

USB chargers (IS13252 (Part 1) / IEC 60950-1)

5734 23	Double USB Charger 2M 2400mA	2332	1/10/100
----------------	------------------------------	------	----------



5734 23



5723 24

Information outlets - toolless

5723 24	Information socket - category 6-UTP- 2 module	1014	10/100
---------	---	------	--------

Hotel internal control units

5720 74	Internal control unit for DND & MMR - 1+1 module	1580	5/50
5720 67	DND & MMR indicator with bell push - 2 module	1984	5/40



5720 74

Audio-video sockets

5732 72	Double RCA socket (audio) - 2 module	■	1/20
5732 73	Triple RCA socket (audio & video) - 2 module	■	1/20
5722 85	HDMI socket - 2 module	■	1/20
5732 74	USB socket - 2 module	■	1/20
5745 01	S-VIDEO socket - 2 module	■	1/20
5722 89	Female HD15 + Jack 3.5 mm - 2 module	■	1/20



5732 74



5745 01

Blanking plate

5730 87	2 modules blank	72	10/100
---------	-----------------	----	--------



5730 87

Round - magnesium mechanisms

Switches - 6 A - 250 V AC

5733 50	Switch - 6 A-SP - 1 way - left - 1 module	262	20/200
5733 51	Switch - 6 A-SP - 1 way - right - 1 module	262	20/200
5733 62	Switch - 6 A-SP - 1 way - middle -1 module	262	20/200
5733 55	Switch - 6 A-SP - 2 way - left -1 module	320	20/200
5733 56	Switch - 6 A-SP - 2 way - right -1 module	320	20/200
5733 52	Switch - 6 A-SP- 1 way with indicator - left - 1 module	356	20/200



5733 50



5733 51



5733 62

Switches - 6 A - 250 V AC

5733 54	Switch - 6 A-SP - 1 way with indicator - right - 1 module	356	20/200
5733 53	Switch - 6 A-SP - 1 way with indicator - middle - 1 module	356	20/200
5733 57	Switch - 6 A-SP - 2 way with indicator - left - 1 module	460	20/200
5733 58	Switch - 6 A-SP - 2 way with indicator - right -1 module	460	20/200



5733 57



5733 71

Switches - 20 A - 250 V AC

5733 70	Switch - 20 A-SP - 1 way - left - 1 module	414	20/200
5733 71	Switch - 20 A-SP - 1 way - right - 1 module	414	20/200

Bold Cat.Nos are products normally available with Legrand (India) Stockists. Cat.Nos that are not bold - delivery within 4 - 8 weeks from the date of order. Bold packing quantity is our mandatory packing. Orders to be placed by Legrand (India) Stockist in multiples of the same.

Arteor™ round - magnesium mechanisms

Cat.Nos	Description	MRP* ₹ / Unit	Pack
Switches - 20 A - 250 V AC			
5731 21	Switch - 20 A-SP- 1 way - middle - 1 module	414	20/200
5733 90	Switch - 20 A-SP - 1 way - 2 module	492	10/100
5725 64	Switch - 20 A-SP - 1 way with indicator - left - 1 module	430	20/200
5725 65	Switch - 20 A-SP - 1 way with indicator - right - 1 module	430	20/200
5731 24	Switch - 20 A-SP - 2 way - middle - 1 module	436	20/200
5733 72	Switch - 20 A-SP - 2 way with indicator - left - 1 module	602	20/200
5733 73	Switch - 20 A-SP - 2 way with indicator - right - 1 module	602	20/200
5731 71	Switch - 20 A-SP - 2 way with indicator - 2 module	574	10/100
5731 72	Switch - 20 A-3 gang - 1 way- 2 module	1188	10/100
5731 73	Switch - 20 A-3 gang - 2x2 way + 1x1 way- 2 module	1254	10/100
5733 92	Switch 20 A-DP - 1 way with indicator - 2 module	928	10/100
5731 27	Switch - 20 A-SP - 2 way with indicator - middle - 1 module	602	20/200



5733 72



5733 92



5733 76



5733 81



5733 59



5733 61



5733 60



5731 03

Switches - 32A

5733 76	Switch - 32 A-DP - 1 way with indicator - 2 module	1338	10/100
---------	--	------	--------

Push button - 6 A - 250 V AC

5733 81	Bell push - 6 A-SP - 1 way - right - 1 module	340	20/200
5733 80	Bell push - 6 A-SP - 1 way - left - 1 module	340	20/200
5733 96	Bell push - 6 A-SP - 1 way - 2 module	482	10/100
5733 59	Push button - 6 A-SP - 1 way - left - 1 module	356	20/200
5733 61	Push button - 6 A-SP - 1 way - right - 1 module	356	20/200
5733 97	Bell push - 6 A-SP - 1 way with indicator - 2 module	634	10/100
5733 60	Push button - 6 A-SP - 1 way - middle - 1 module	356	20/200

Electronic roller blinds control

5737 20	Double pole switch 10 A - 2 module	848	10/100
---------	------------------------------------	-----	--------

Dimmers and fan regulators

5733 66	Light dimmer - 60 to 400 watts - 2 module	1404	1/10/100
5731 03	Fan step regulator - 100 watts - 2 module	1366	1/10/100
5731 69	Fan step regulator - 120 watts - 2 module	1476	1/10/100
5731 04	Fan step regulator- 2 module for energy saving fans	1456	1/10/100

* MRP - Maximum Retail Price Inclusive of all taxes including GST.

Red Cat.Nos - new products

■ Price available on request.

Arteor™ round - magnesium mechanisms

Cat.Nos	Description	MRP* ₹ / Unit	Pack
Electronic dimmer			
5743 39	Universal dimmer without neutral 400 W - 2 module	■	1/10
Multistandard sockets			
5736 89	Multistandard socket 6/10/13 A - 2/3 pin for 250 V AC 15 A for 127 V type - 2 pin 2 module	500	10/100
USB chargers (IS13252 (Part 1) / IEC 60950-1)			
5736 23	Double USB Charger 2M 2400mA	2672	1/10/100
Information outlets - toolless			
5728 24	Information socket - category 6 - UTP - 2 module	1160	10/100
Hotel internal control units			
5725 74	Internal control unit for DND & MMR - 1+1 module	1812	5/50
5725 67	DND & MMR Indicator with bell push - 2 module	2164	5/40
Audio-video sockets			
5737 72	Double RCA socket (audio) - 2 module	■	1/20
5737 73	Triple RCA socket (audio & video) - 2 module	■	1/20
5727 85	HDMI socket - 2 module	■	1/20
5737 74	USB socket - 2 module	■	1/20
5745 51	S-VIDEO socket - 2 module	■	1/20
5727 89	Female HD15 + jack 3.5 mm - 2 module	■	1/20
Blanking plate			
5731 87	2 modules blank	84	10/100
Round - champagne mechanisms			
Switches - 6 A - 250 V AC			
5749 00	Switch - 6 A-SP - 1 way - left - 1 module	262	20/200
5749 01	Switch - 6 A-SP - 1 way - right - 1 module	262	20/200
5749 02	Switch - 6 A-SP - 1 way - middle - 1 module	262	20/200
5749 03	Switch - 6 A-SP - 2 way - left - 1 module	320	20/200
5749 04	Switch - 6 A-SP - 2 way - right - 1 module	320	20/200
5749 05	Switch - 6 A-SP - 1 way with indicator - left - 1 module	356	20/200
5749 06	Switch - 6 A-SP - 1 way with indicator - right - 1 module	356	20/200
5749 07	Switch - 6 A-SP - 1 way with indicator - middle - 1 module	356	20/200
5749 08	Switch - 6 A-SP - 2 way with indicator - left - 1 module	460	20/200
5749 09	Switch - 6 A-SP - 2 way with indicator - right - 1 module	460	20/200



5728 24



5725 74



5725 67



5737 73



5727 85



5731 87

NEW!



5749 00



5749 01



5749 02

Bold Cat.Nos are products normally available with Legrand (India) Stockists. Cat.Nos that are not bold - delivery within 4 - 8 weeks from the date of order. Bold packing quantity is our mandatory packing. Orders to be placed by Legrand (India) Stockist in multiples of the same.

Arteor™ round - champagne mechanisms

NEW!

Cat.Nos	Description	MRP* ₹ / Unit	Pack
---------	-------------	------------------	------

Switches - 20 A - 250 V AC

5749 10	Switch - 20 A-SP - 1 way - left - 1 module	414	20/200
5749 11	Switch - 20 A-SP - 1 way - right - 1 module	414	20/200
5749 12	Switch - 20 A-SP- 1 way - middle - 1 module	414	20/200
5749 13	Switch - 20 A-SP - 1 way - 2 module	492	10/100
5749 14	Switch - 20 A-SP - 1 way with indicator - left - 1 module	430	20/200
5749 15	Switch - 20 A-SP - 1 way with indicator - right - 1 module	430	20/200
5749 16	Switch - 20 A-SP - 2 way - middle - 1 module	436	20/200
5749 17	Switch - 20 A-SP - 2 way with indicator - left - 1 module	602	20/200
5749 18	Switch - 20 A-SP - 2 way with indicator - right - 1 module	602	20/200
5749 19	Switch - 20 A-SP - 2 way with indicator - 2 module	574	10/100
5749 20	Switch - 20 A-3 gang - 1 way- 2 module	1188	10/100
5749 21	Switch - 20 A-3 gang - 2x2 way + 1x1 way- 2 module	1254	10/100
5749 22	Switch 20 A-DP - 1 way with indicator - 2 module	928	10/100

Push button - 6 A - 250 V AC

5749 23	Bell push - 6 A-SP - 1 way - right - 1 module	340	20/200
5749 24	Bell push - 6 A-SP - 1 way - left - 1 module	340	20/200
5749 25	Bell push - 6 A-SP- 1 way - 2 module	482	10/100
5749 26	Bell push - 6 A-SP - 1 way with indicator - 2 module	634	10/100

Dimmers and fan regulators

5749 27	Light dimmer - 60 to 400 watts - 2 module	1404	1/10/100
5749 29	Fan step regulator - 100 watts - 2 module	1366	1/10/100
5749 30	Fan step regulator - 120 watts - 2 module	1476	1/10/100
5749 31	Fan step regulator- 2 module for energy saving fans	1456	1/10/100

Multistandard sockets

5749 40	Multistandard socket 6/10/13 A - 2/3 pin for 250 V AC 15 A for 127 V type - 2 pin 2 module	500	10/100
---------	--	-----	--------

USB chargers (IS13252 (Part 1) / IEC 60950-1)

5749 44	Double USB Charger 2M 2400mA	2672	1/10/100
---------	------------------------------	------	----------

Blanking plate

574964	2 modules blank	84	10/100
--------	-----------------	----	--------

* MRP - Maximum Retail Price Inclusive of all taxes including GST.
Red Cat.Nos - new products

Arteor™ square cover plates

Cat.Nos	Description	MRP* ₹ / Unit	Pack
---------	-------------	------------------	------

White cover plates with frame

5757 00	White plate - 1 module	156	10/100
5757 10	White plate - 2 module	166	10/100
5757 20	White plate - 3 module	182	10/100
5757 30	White plate - 4 module	196	5/50
5757 40	White plate - 6 module	354	5/30
5757 50	White plate - 8 module	396	5/30
5757 60	White plate - 2x4 module	496	2/20
5757 70	White plate - 2x6 module	606	2/16
5757 80	White plate - 2x8 module	728	2/16
5757 90	White plate - 3x6 module	804	2/12
5758 00	White plate - 3x8 module	962	2/12
5750 70	White plate for shaver socket 3 module	278	5/50

Pearl aluminium cover plates with frame

5757 01	Pearl aluminium plate - 1 module	258	10/100
5757 11	Pearl aluminium plate - 2 module	272	10/100
5757 21	Pearl aluminium plate - 3 module	290	10/100
5757 31	Pearl aluminium plate - 4 module	328	5/50
5757 41	Pearl aluminium plate - 6 module	562	5/30
5757 51	Pearl aluminium plate - 8 module	620	5/30
5757 61	Pearl aluminium plate - 2x4 module	788	2/20
5757 71	Pearl aluminium plate - 2x6 module	1024	2/16
5757 81	Pearl aluminium plate - 2x8 module	1158	2/16
5757 91	Pearl aluminium plate - 3x6 module	1354	2/12
5758 01	Pearl aluminium plate - 3x8 module	1542	2/12
5750 71	Pearl aluminium plate for shaver socket 3 module	442	5/50

Graphite cover plates with frame

5757 02	Graphite plate - 1 module	258	10/100
5757 12	Graphite plate - 2 module	272	10/100
5757 22	Graphite plate - 3 module	290	10/100
5757 32	Graphite plate - 4 module	328	5/50
5757 42	Graphite plate - 6 module	562	5/30
5757 52	Graphite plate - 8 module	620	5/30
5757 62	Graphite plate - 2x4 module	788	2/20
5757 72	Graphite plate - 2x6 module	1024	2/16
5757 82	Graphite plate - 2x8 module	1158	2/16
5757 92	Graphite plate - 3x6 module	1354	2/12
5758 02	Graphite plate - 3x8 module	1542	2/12
5750 72	Graphite plate for shaver socket 3 module	442	5/50

Magnesium cover plates with frame

5758 11	Magnesium plate - 1 module	258	10/100
5758 12	Magnesium plate - 2 module	272	10/100

Bold Cat.Nos are products normally available with Legrand (India) Stockists. Cat.Nos that are not bold - delivery within 4 - 8 weeks from the date of order. Bold packing quantity is our mandatory packing. Orders to be placed by Legrand (India) Stockist in multiples of the same.

Arteor™ square cover plates

NEW!

Cat.Nos	Description	MRP* ₹ / Unit	Pack
---------	-------------	------------------	------

Magnesium cover plates with frame

5758 13	Magnesium plate - 3 module	290	10/100
5758 14	Magnesium plate - 4 module	326	5/50
5758 15	Magnesium plate - 6 module	560	5/30
5758 16	Magnesium plate - 8 module	620	5/30
5758 17	Magnesium plate - 2x4 module	788	2/20
5758 18	Magnesium plate - 2x6 module	1024	2/16
5758 19	Magnesium plate - 2x8 module	1158	2/16
5758 20	Magnesium plate - 3x6 module	1354	2/12
5758 21	Magnesium plate for shaver socket 3 module	442	5/50

Champagne cover plates with frame

5758 22	Champagne plate - 1 module	258	10/100
5758 23	Champagne plate - 2 module	272	10/100
5758 24	Champagne plate - 3 module	290	10/100
5758 25	Champagne plate - 4 module	326	5/50
5758 26	Champagne plate - 6 module	560	5/30
5758 27	Champagne plate - 8 module	620	5/30
5758 28	Champagne plate - 2x4 module	788	2/20
5758 29	Champagne plate - 2x6 module	1024	2/16
5758 30	Champagne plate - 2x8 module	1158	2/16
5758 31	Champagne plate - 3x6 module	1354	2/12
5758 32	Champagne plate for shaver socket 3 module	442	5/50

Dark Bronze cover plates with frame

5758 33	Dark Bronze plate - 1 module	258	10/100
5758 34	Dark Bronze plate - 2 module	272	10/100
5758 35	Dark Bronze plate - 3 module	290	10/100
5758 36	Dark Bronze plate - 4 module	326	5/50
5758 37	Dark Bronze plate - 6 module	560	5/30
5758 38	Dark Bronze plate - 8 module	620	5/30
5758 39	Dark Bronze plate - 2x4 module	788	2/20
5758 40	Dark Bronze plate - 2x6 module	1024	2/16
5758 41	Dark Bronze plate - 2x8 module	1158	2/16
5758 42	Dark Bronze plate - 3x6 module	1354	2/12
5758 43	Dark Bronze plate for shaver socket 3 module	442	5/50

Arteor™ square cover plates

Cat.Nos	Description	MRP* ₹ / Unit	Pack
---------	-------------	------------------	------

Mirror finish cover plates with frame

5757 03	Mirror black plate - 1 module	1488	1/5/30
5757 13	Mirror black plate - 2 module	1592	1/5/30
5757 23	Mirror black plate - 3 module	1706	1/20
5757 33	Mirror black plate - 4 module	1812	1/20
5757 43	Mirror black plate - 6 module	3300	1/5
5757 53	Mirror black plate - 8 module	3630	1/5
5757 63	Mirror black plate - 2x4 module	4600	1/10
5757 73	Mirror black plate - 2x6 module	5660	1/8
5750 73	Mirror black plate for shaver socket 3 module	2336	1/5/50
5757 04	Mirror white plate - 1 module	1488	1/5/30
5757 14	Mirror white plate - 2 module	1592	1/5/30
5757 24	Mirror white plate - 3 module	1706	1/20
5757 34	Mirror white plate - 4 module	1812	1/20
5757 44	Mirror white plate - 6 module	3300	1/5
5757 54	Mirror white plate - 8 module	3630	1/5
5757 64	Mirror white plate - 2x4 module	4690	1/10
5757 74	Mirror white plate - 2x6 module	5660	1/8
5750 74	Mirror white plate for shaver socket 3 module	2336	1/5/50
5758 44	Green Apple plate - 1 module	1488	1/5/30
5758 45	Green Apple plate - 2 module	1592	1/5/30
5758 46	Green Apple plate - 3 module	1706	1/20
5758 47	Green Apple plate - 4 module	1812	1/20
5758 48	Green Apple plate - 6 module	3300	1/5
5758 49	Green Apple plate - 8 module	3630	1/5
5758 50	Green Apple plate - 2x4 module	4688	1/10
5758 51	Green Apple plate - 2x6 module	5660	1/8
5758 52	Green Apple plate for shaver socket 3 module	2482	1/5/50

Graphic cover plates with frame

5762 91	Graphic casual plate - 1 module	1806	1/5/30
5763 11	Graphic casual plate - 2 module	1946	1/5/30
5763 31	Graphic casual plate - 3 module	2090	1/5/20
5763 51	Graphic casual plate - 4 module	2230	1/20
5763 81	Graphic casual plate - 6 module	4034	1/5

* MRP - Maximum Retail Price Inclusive of all taxes including GST.
Red Cat.Nos - new products

Bold Cat.Nos are products normally available with Legrand (India) Stockists. Cat.Nos that are not bold - delivery within 4 - 8 weeks from the date of order. Bold packing quantity is our mandatory packing. Orders to be placed by Legrand (India) Stockist in multiples of the same.

Arteor™ square cover plates

Cat.Nos	Description	MRP* ₹ / Unit	Pack
Graphic cover plates with frame			
5764 01	Graphic casual plate - 8 module	4450	1/5
5758 89	Graphic casual plate - 2x4 module	5606	1/10
5758 90	Graphic casual plate - 2x6 module	6942	1/8
5761 61	Graphic casual for shaver socket 3 module	2854	1/5/50

NEW!

Silver Baroque plates with frame

5758 53	Silver Baroque plate - 1 module	1806	1/5/30
5758 54	Silver Baroque plate - 2 module	1946	1/5/30
5758 55	Silver Baroque plate - 3 module	2090	1/20
5758 56	Silver Baroque plate - 4 module	2230	1/20
5758 57	Silver Baroque plate - 6 module	4034	1/5
5758 58	Silver Baroque plate - 8 module	4450	1/5
5758 59	Silver Baroque plate - 2x4 module	5606	1/10
5758 60	Silver Baroque plate - 2x6 module	6942	1/8
5758 61	Silver Baroque plate for shaver socket 3 module	2854	1/5/50

NEW!

Dark Baroque plates with frame

5758 62	Dark Baroque plate - 1 module	1806	1/5/30
5758 63	Dark Baroque plate - 2 module	1946	1/5/30
5758 64	Dark Baroque plate - 3 module	2090	1/20
5758 65	Dark Baroque plate - 4 module	2230	1/20
5758 66	Dark Baroque plate - 6 module	4034	1/5
5758 67	Dark Baroque plate - 8 module	4450	1/5
5758 68	Dark Baroque plate - 2x4 module	5606	1/10
5758 69	Dark Baroque plate - 2x6 module	6942	1/8
5758 70	Dark Baroque plate for shaver socket 3 module	2854	1/5/50

Metal finish cover plates with frame

5762 90	Gold brass plate - 1 module	2426	1/5/30
5763 10	Gold brass plate - 2 module	2596	1/5/30
5763 30	Gold brass plate - 3 module	2792	1/20
5763 50	Gold brass plate - 4 module	2964	1/20
5763 80	Gold brass plate - 6 module	5392	1/5
5764 00	Gold brass plate - 8 module	5928	1/5
5761 60	Gold brass plate - for shaver socket 3 module	3180	1/5/50
5757 06	Stainless steel plate - 1 module	2426	1/5/30
5757 16	Stainless steel plate - 2 module	2596	1/5/30
5757 26	Stainless steel plate - 3 module	2792	1/20
5757 36	Stainless steel plate - 4 module	2964	1/20

* MRP - Maximum Retail Price Inclusive of all taxes including GST.
Red Cat.Nos - new products

Arteor™ square cover plates

Cat.Nos	Description	MRP* ₹ / Unit	Pack
Metal finish cover plates with frame			
5757 46	Stainless steel plate - 6 module	5392	1/5
5757 66	Stainless steel plate - 2x4 module	7496	1/10
5757 56	Stainless steel plate - 8 module	5928	1/5
5757 76	Stainless steel plate - 2x6 module	9238	1/8
5750 76	Stainless steel plate - for shaver socket 3 module	3180	1/5/50



5757 66

NEW!

Wood cover plates with frame

5758 80	Grey Oak plate - 1 module	1422	1/5/30
5758 81	Grey Oak plate - 2 module	1506	1/5/30
5758 82	Grey Oak plate - 3 module	1862	1/20
5758 83	Grey Oak plate - 4 module	2064	1/20
5758 84	Grey Oak plate - 6 module	3064	1/5
5758 85	Grey Oak plate - 8 module	3690	1/5
5758 86	Grey Oak plate - 2x4 module	4374	1/10
5758 87	Grey Oak plate - 2x6 module	5864	1/8
5758 88	Grey Oak plate for shaver socket 3 module	1818	1/5/50

NEW!

Signature cover plates with frame

5758 71	Cube plate - 1 module	4650	1/5/30
5758 72	Cube plate - 2 module	4734	1/5/30
5758 73	Cube plate - 3 module	5412	1/20
5758 74	Cube plate - 4 module	5592	1/20
5758 75	Cube plate - 6 module	7286	1/5
5758 76	Cube plate - 8 module	7650	1/5
5758 77	Cube plate - 2x4 module	11428	1/10
5758 78	Cube plate - 2x6 module	12660	1/8
5758 79	Cube plate for shaver socket 3 module	5192	1/5/50

Round cover plates

White cover plates with frame

5759 00	White plate - 2 module	242	10/100
5759 10	White plate - 3 module	252	10/100
5759 20	White plate - 4 module	266	5/50
5759 30	White plate - 6 module	486	5/30
5765 80	White plate - 8 module	536	5/30
5759 40	White plate - 2x4 module	566	2/20
5759 50	White plate - 2x6 module	828	2/16



5759 10



5759 30

Bold Cat.Nos are products normally available with Legrand (India) Stockists. Cat.Nos that are not bold - delivery within 4 - 8 weeks from the date of order. Bold packing quantity is our mandatory packing. Orders to be placed by Legrand (India) Stockist in multiples of the same.

Arteor™ round cover plates

Cat.Nos	Description	MRP* ₹ / Unit	Pack
---------	-------------	------------------	------

Pearl aluminium cover plates with frame

5759 01	Pearl aluminium plate - 2 module	358	10/100
5759 11	Pearl aluminium plate - 3 module	376	10/100
5759 21	Pearl aluminium plate - 4 module	402	5/50
5759 31	Pearl aluminium plate - 6 module	728	5/30
5765 81	Pearl aluminium plate - 8 module	800	5/30
5759 41	Pearl aluminium plate - 2x4 module	840	2/20
5759 51	Pearl aluminium plate - 2x6 module	1248	2/16

Graphite cover plates with frame

5759 02	Graphite plate - 2 module	358	10/100
5759 12	Graphite plate - 3 module	376	10/100
5759 22	Graphite plate - 4 module	402	5/50
5759 32	Graphite plate - 6 module	728	5/30
5765 82	Graphite plate - 8 module	800	5/30
5759 42	Graphite plate - 2x4 module	840	2/20
5759 52	Graphite plate - 2x6 module	1248	2/16

Magnesium cover plates with frame

5768 41	Magnesium plate - 2 module	358	10/100
5768 42	Magnesium plate - 3 module	378	10/100
5768 43	Magnesium plate - 4 module	404	5/50
5768 44	Magnesium plate - 6 module	728	5/30
5768 45	Magnesium plate - 8 module	800	5/30
5768 46	Magnesium plate - 2x4 module	840	2/20
5768 47	Magnesium plate - 2x6 module	1246	2/16

Champagne cover plates with frame

5768 48	Champagne plate - 2 module	358	10/100
5768 49	Champagne plate - 3 module	378	10/100
5768 50	Champagne plate - 4 module	404	5/50
5768 51	Champagne plate - 6 module	728	5/30
5768 52	Champagne plate - 8 module	800	5/30
5768 53	Champagne plate - 2x4 module	840	2/20
5768 54	Champagne plate - 2x6 module	1246	2/16

Dark Bronze cover plates with frame

5768 55	Dark Bronze plate - 2 module	358	10/100
5768 56	Dark Bronze plate - 3 module	378	10/100

Arteor™ square cover plates

Cat.Nos	Description	MRP* ₹ / Unit	Pack
---------	-------------	------------------	------

Dark Bronze cover plates with frame

5768 57	Dark Bronze plate - 4 module	404	5/50
5768 58	Dark Bronze plate - 6 module	728	5/30
5768 59	Dark Bronze plate - 8 module	800	5/30
5768 60	Dark Bronze plate - 2x4 module	840	2/20
5768 61	Dark Bronze plate - 2x6 module	1246	2/16

Mirror finish cover plates with frame

5759 03	Mirror black plate - 2 module	1758	1/5/30
5759 13	Mirror black plate - 3 module	1880	1/20
5759 23	Mirror black plate - 4 module	2000	1/20
5759 33	Mirror black plate - 6 module	3622	1/5
5765 83	Mirror black plate - 8 module	4000	1/5
5759 43	Mirror black plate - 2x4 module	4718	1/10
5759 53	Mirror black plate - 2x6 module	6234	1/8
5759 04	Mirror white plate - 2 module	1758	1/5/30
5759 14	Mirror white plate - 3 module	1880	1/20
5759 24	Mirror white plate - 4 module	2000	1/20
5759 34	Mirror white plate - 6 module	3622	1/5
5765 84	Mirror white plate - 8 module	4000	1/5
5759 44	Mirror white plate - 2x4 module	4812	1/10
5759 54	Mirror white plate - 2x6 module	6234	1/8
5768 62	Green Apple plate - 2 module	1758	1/5/30
5768 63	Green Apple plate - 3 module	1880	1/20
5768 64	Green Apple plate - 4 module	2000	1/20
5768 65	Green Apple plate - 6 module	3622	1/5
5768 67	Green Apple plate - 8 module	4812	1/5
5768 68	Green Apple plate - 2x4 module	6234	1/10
5768 66	Green Apple plate - 2x6 module	4000	1/8

Graphic cover plates with frame

5763 01	Graphic casual plate - 2 module	2144	1/5/30
5763 21	Graphic casual plate - 3 module	2296	1/20
5763 41	Graphic casual plate - 4 module	2448	1/20
5763 61	Graphic casual plate - 6 module	4444	1/5
5763 91	Graphic casual plate - 8 module	4890	1/5
5768 97	Graphic casual plate - 2x4 module	5872	1/10
5768 98	Graphic casual plate - 2x6 module	7630	1/8

* MRP - Maximum Retail Price Inclusive of all taxes including GST.
Red Cat.Nos - new products

Bold Cat.Nos are products normally available with Legrand (India) Stockists.
Cat.Nos that are not bold - delivery within 4 - 8 weeks from the date of order.
Bold packing quantity is our mandatory packing. Orders to be placed by Legrand (India) Stockist in multiples of the same.

Arteor™ round cover plates

Cat.Nos	Description	MRP* ₹ / Unit	Pack
---------	-------------	------------------	------

NEW!

Silver Baroque cover plates with frame

5768 69	Silver Baroque plate - 2 module	2144	1/5/30
5768 70	Silver Baroque plate - 3 module	2296	1/20
5768 71	Silver Baroque plate - 4 module	2448	1/20
5768 72	Silver Baroque plate - 6 module	4444	1/5
5768 73	Silver Baroque plate - 8 module	4890	1/5
5768 74	Silver Baroque plate - 2x4 module	5872	1/10
5768 75	Silver Baroque plate - 2x6 module	7630	1/8

NEW!

Dark Baroque cover plates with frame

5768 76	Dark Baroque plate - 2 module	2144	1/5/30
5768 77	Dark Baroque plate - 3 module	2296	1/20
5768 78	Dark Baroque plate - 4 module	2448	1/20
5768 79	Dark Baroque plate - 6 module	4444	1/5
5768 80	Dark Baroque plate - 8 module	4890	1/5
5768 81	Dark Baroque plate - 2x4 module	5872	1/10
5768 82	Dark Baroque plate - 2x6 module	7630	1/8

Metal finish cover plates with frame

5763 00	Gold brass plate - 2 module	2860	1/5/30
5763 20	Gold brass plate - 3 module	3056	1/20
5763 40	Gold brass plate - 4 module	3262	1/20
5763 60	Gold brass plate - 6 module	5924	1/5
5763 90	Gold brass plate - 8 module	6526	1/5
5759 06	Stainless steel plate - 2 module	2860	1/5/30
5759 16	Stainless steel plate - 3 module	3056	1/20
5759 26	Stainless steel plate - 4 module	3262	1/20
5759 36	Stainless steel plate - 6 module	5924	1/5
5765 86	Stainless steel plate - 8 module	6526	1/5
5759 46	Stainless steel plate - 2x4 module	8256	1/10
5759 56	Stainless steel plate - 2x6 module	10160	1/8

NEW!

Wood cover plates with frame

5768 90	Grey Oak plate - 2 module	1506	1/5/30
5768 91	Grey Oak plate - 3 module	2226	1/20
5768 92	Grey Oak plate - 4 module	2310	1/20
5768 93	Grey Oak plate - 6 module	3280	1/5

Arteor™ round cover plates

Cat.Nos	Description	MRP* ₹ / Unit	Pack
---------	-------------	------------------	------

NEW!

Wood cover plates with frame

5768 94	Grey Oak plate - 8 module	3996	1/5
5768 95	Grey Oak plate - 2x4 module	4272	1/10
5768 96	Grey Oak plate - 2x6 module	5470	1/8

NEW!

Signature cover plates with frame

5768 83	Cube plate - 2 module	4734	1/5/30
5768 84	Cube plate - 3 module	5754	1/20
5768 85	Cube plate - 4 module	5860	1/20
5768 86	Cube plate - 6 module	7502	1/5
5768 87	Cube plate - 8 module	7956	1/5
5768 88	Cube plate - 2x4 module	11068	1/10
5768 89	Cube plate - 2x6 module	12524	1/8

Accessories

Plastic surface boxes

5734 91	Surface box - 1/2 module	98	10/50
5735 20	Surface box - 3 module	118	5/35
5735 70	Surface box - 4 module	146	5/25
5735 71	Surface box - 6 module	176	1/10
5723 94	Surface box - 8 module	198	1/10
5735 74	Surface box - 2x4 module	244	2/10
5735 72	Surface box - 12/16 module	620	2/10
5735 73	Surface box - 18/24 module	658	2/8

Metal flush boxes

6890 07	Metal flush mounting Box - 1/2 module	98	40
6890 08	Metal flush mounting Box - 3 module	98	40
6890 09	Metal flush mounting Box - 4 module	132	40
6890 10	Metal flush mounting Box - 6 module	206	40
6890 42	Metal flush mounting Box - 8 module	242	40
6890 31	Metal flush mounting Box - 4x2 module	240	20
6890 11	Metal flush mounting Box - 12 / 16 module	364	10
6890 12	Metal flush mounting Box - 18 / 24 module	458	10

IP 55 Plexo box and accessories

0696 51	Grey Plexo box for 2 module	258	10/100
0696 72	Grey Plexo box for 2 x 2 module use two nos. of 0695 80	842	5/50

* MRP - Maximum Retail Price Inclusive of all taxes including GST.
Red Cat.Nos - new products

Bold Cat.Nos are products normally available with Legrand (India) Stockists. Cat.Nos that are not bold - delivery within 4 - 8 weeks from the date of order. Bold packing quantity is our mandatory packing. Orders to be placed by Legrand (India) Stockist in multiples of the same.

Arteor™ round cover plates

Cat.Nos	Description	MRP* ₹ / Unit	Pack
IP 55 Plexo box and accessories			
0695 80	Grey Plexo box for 2 x 2 x 2 module use three nos. of 0695 80	1128	5/25
0696 89	White Plexo box for 2 module	316	10/100
IP 55 Plexo box and accessories			
0695 80	Grey/White adaptor for IP 55 Plexo with smoked polycarbonate flap for 2 modules	968	10/100
6846 38	Grey Plexo box & adaptor with transparent flap for 3 modules, IP 66	3868	1
IP 55 Plexo box with PVC membrane			
6806 11	Grey Plexo box & adaptor with PVC membrane - 1 module	850	10
6806 12	Grey Plexo box & adaptor with PVC membrane - 2 module	872	10
6806 13	Grey Plexo box & adaptor with PVC membrane - 3 module	1160	10
6806 14	Grey Plexo box & adaptor with PVC membrane - 4 module	1738	5
6806 19	Grey Plexo box & adaptor with PVC membrane - 2 row x 4 module	2826	5
6806 33	Grey Plexo flush adaptor with membrane for 3 module Arteor™ box	930	20

ARTEOR™ | FLOW OF ENERGIES

Guarantee

- The Company at its discretion, will replace products if they have any manufacturing defect within 10 years for switches (without LED lamp) and power sockets. For all other **Arteor™** wiring accessories the guarantee will be 2 years.
- The above guarantee is applicable when the devices are used in Legrand metal flush boxes. Other wise the guarantee period will be reduced by 50%.
- The guarantee is only applicable when the products are installed as per the Company's instructions and not tampered in any manner.
- The guarantee states the Company's entire liability. It does not extend to cover consequential loss or damage or installation costs arising from defective products.

* MRP - Maximum Retail Price Inclusive of all taxes including GST.

Arteor™ a rich choice of finishes

A wide range of finishes and materials for perfect harmony with modern environments, whether residential or commercial.

GLOBAL SPECIALIST
IN ELECTRICAL AND DIGITAL BUILDING INFRASTRUCTURES

Bold Cat.Nos are products normally available with Legrand (India) Stockists. Cat.Nos that are not bold - delivery within 4 - 8 weeks from the date of order. Bold packing quantity is our mandatory packing. Orders to be placed by Legrand (India) Stockist in multiples of the same.



Remote control switch for light and fan

- Can control 4 lights & 1 fan
- 10 different speed options for fan
- Night lamp on product panel with manual operation option for all functions



Skirting light

- Fitted into the walls at skirting level
- Provides a dim lighting
- Creates a path light during night
- Uses LEDs that saves energy



VSP - Voltage Surge protectors

- Protects electrical devices like laptops, computers, printers and other office equipments from voltage surge
- Blends very well with the modular range of wiring devices



Motion sensor

- Infrared detectors that detect human movements
- Programmed to automatically switch the device on and switch off when not in use, thus, saves energy



Introducing a new range of plates with unique features & flawless designs, Myrius perfectly defines aestheticism. This range includes two shades; grainy matte black and a glossy white that suits any decor. Also, the designs are crafted with sheer perfection that create an ambience in itself.



Black Beauty

A mystic black shade with a grainy matte finish truly complements any decor.



Dimmer

- Creates the perfect ambience
- For the first time dims CFLs too
- Dims halogen lamps



Motor Starter

- Complete protection against overload
- Aesthetically appealing
- For ACs/Geysers etc.



Snowy White

Its gleaming white shade and a perfect glossy finish creates a soothing decor.

Myrius™ More is on.

Be it a couple of extra zeroes to a pay cheque or one more holiday to the list. Be it one more pair of shoes to the collection or just requesting for one more song at a party. It's natural for humans to always expect something more.

MORE AESTHETICS

Flat, sleek and smooth, Myrius with its curved edges gives it a distinct and appealing look to everyone. Moreover, its minimalistic design makes it look absolutely stunning and desirable. But what makes Myrius truly beautiful is a classic black and white shade that offers an aura of comfort and timelessness.



Fan regulator



TV/SAT/FM socket



Telephone Socket



Light Marking



AV Connector



RJ 45 Data Socket



Projector connector



Key Fob Switch



Do not disturb Switch

Myrius™
Anti-bacterial





Shaver socket



USB Charger



Modular MCB

Myrius™ More is on.

More acceptance, always and everywhere.

Myrius range of wiring accessories is a classic creation to increase the customer's comfort and improve the work environment. This wide range of innovative products offers solutions for residential, commercial and hospitality projects, thus making it a range that caters to everyone's needs.



Myrius™ mechanisms - white

Cat.Nos	Description	MRP* ₹ / Unit	Pack
---------	-------------	------------------	------

Switches - 6 A - 230 V~

6730 00	6 A switch 1 W - 1 module	122	20/200
6730 01	6 A switch 2 W - 1 module	192	20/200
6730 02	6 A switch 1 W - 1 module with indicator	176	20/200
6730 03	6 A switch 1 W - 1 module with "Light" marking	150	20/200
6730 04	6 A switch 1 W - 1 module with "Fan" marking	150	20/200

Switches - 10 A - 230 V~

6730 05	10 A switch 1 W - 2 module	222	10/100
6730 06	10 A switch 2 W - 2 module	262	10/100
6730 17	10 A intermediate - 2 module	1436	10/100
6730 07	10 A switch 1 W with indicator - 2 module	276	10/100

Switches - 16 A - 230 V~

6730 08	16 A switch 1 W - 1 module	250	20/200
6730 09	16 A switch 2 W - 1 module	288	20/200
6730 10	16 A switch 1 W with indicator - 1 module	304	20/200

Switches - 20 A - 230 V~

6730 11	20 A 1 W switch - 1 module	332	20/200
6730 12	20 A DP 1 W switch - 2 module	508	10/100
6730 13	20 A DP 1 W switch with indicator - 2 module	540	10/100
6730 14	20 A 2 W switch - 2 module	562	10/100

Switches - 25 A - 230 V~

6730 15	25 A SP 1 W switch with indicator - 1 module	374	20/200
---------	--	-----	--------

Switches - 32 A - 230 V~

6730 16	32 A DP switch with indicator - 2 module	832	10/100
---------	--	-----	--------

* MRP - Maximum Retail Price Inclusive of all taxes including GST.

Myrius™ mechanisms - white

Cat.Nos	Description	MRP* ₹ / Unit	Pack
---------	-------------	------------------	------

Push buttons

6730 18	6 A push button SP - 1 module	214	20/200
6730 19	6 A push button SP with indicator - 1 module	276	20/200
6730 20	6 A bell push - 1 module	210	20/200
6730 21	6 A bell push with indicator - 1 module	276	20/200
6730 22	6 A bell push - 2 module	318	10/100
6730 23	6 A bell push with indicator - 2 module	374	10/100

Accessories for switches with indicator

6732 44	Lamp for switches / push buttons	46	5/50
---------	----------------------------------	----	------

Socket - 230 V~

6730 41	6/16 A 2 Pin Euro US socket - 1 module	292	20/200
6730 42	16 A 3 Pin switched socket - 3 module	950	5/50
6730 43	Multistandard socket 6/10/13 A - 2/3 pin for 250 V AC 15 A for 127 V type - 2 pin 2 module	318	10/100
6730 44	6 A 5 Pin universal socket - 2 module	274	20/200
6730 83	6/16 A socket - 3 module	442	5/50
6730 45	6/16 A socket - 2 module	372	10/100
6730 46	6/16 A - Euro socket - 2 module	424	10/100
6730 47	25 A socket - 2 module	468	10/100

Power unit

6730 74	Power strip - 8 module 6 A (2 nos.) + 16 A socket (1 no.) + 16 A switch with indicator (1 no.)	2164	1/10
6730 75	Power strip - 8 module 5 Pin 6 A (3 nos.) + 16 A switch with indicator (1 no.)	1698	1/10
6730 76	Power strip - 8 module multistd socket (3 nos.) + 16 A switch (1 no.)	1674	1/10

Bold Cat.Nos are products normally available with Legrand (India) Stockists. Cat.Nos that are not bold - delivery within 4 - 8 weeks from the date of order. Bold packing quantity is our mandatory packing. Orders to be placed by Legrand (India) Stockist in multiples of the same.

Myrius™ mechanisms - white

Cat.Nos	Description	MRP* ₹ / Unit	Pack
---------	-------------	------------------	------

Dimmer & regulator

6730 24	Rotary dimmer 400 W - 1 module	918	1/5/50
6730 25	Rotary dimmer 650 W - 3 module	1926	1/10
6730 26	Compact fluorescent lamp dimmer - 2 module	2554	1/10
6730 27	Fan step regulator 100 W - 1 module	716	1/5/50
6730 29	Fan step regulator 100 W - 2 module	820	1/10/100
6730 28	Fan step regulator 120 W - 2 module	886	1/10/100
6730 77	Fan step regulator - 2 module for energy saving fans	858	1/10/100

Electronic touch dimmer

6731 38	Universal touch dimmer 3 M	5946	1/10
---------	----------------------------	------	------

Emergency light

0785 12	Emergency light unit - 2 module	5892	1/1
---------	---------------------------------	------	-----

Indicators

0785 73	Triangular bulkhead - Blue - 2 module	246	1/1
0785 71	Triangular bulkhead - colourless - 2 module	246	1/1
0785 72	Triangular bulkhead - green - 2 module	270	1/1
0785 70	Triangular bulkhead - red - 2 module	270	1/1

Skirting light

6730 36	Skirting light with white LED - 3 module	694	1/5/25
---------	--	-----	--------

Bell indicator

6730 33	Bell indicator - 240 V~ - 1 module	1002	20/200
---------	------------------------------------	------	--------

Buzzer

6730 34	Buzzer - 230 V~ - 1 module	990	20/200
---------	----------------------------	-----	--------

Remote unit

6730 73	Remote control switch - 4 module	7270	1/5/20
---------	----------------------------------	------	--------

Hospitality functions

Key FOB switch

6730 37	15 A key card switch monobloc with plate - 2 M	3312	1/10
6732 37	15 A key card switch monobloc with new plate - 2 M White	3646	1/10
6730 38	Only key fob for switch Cat.No 6730 37 & 6732 37	158	1/10/100

Myrius™ mechanisms - white

Cat.Nos	Description	MRP* ₹ / Unit	Pack
---------	-------------	------------------	------

"Do Not Disturb" and MMR control unit

6730 39	External unit - 1+1 module	1412	10/100
6730 40	Internal unit - 1+1 module	944	10/100

Shaver socket

6730 49	Shaver Socket 230 V / 120 - 230 V monobloc with plate - 4 M	4168	1/5/20
6730 79	Shaver Socket 230 V / 120 - 230 V monobloc with new plate - 4 M White	4370	1/5

Sockets and connectors

TV socket

6730 50	TV socket - 1 module	184	20/200
6730 51	TV / Sat / FM 6 shielded socket 2 module	1646	10/100

Data & voice

6730 52	RJ-11 telephone socket with transparent shutter 1 module	182	20/200
6730 53	RJ-11 double telephone socket with shutter 1 module	280	20/200
6730 54	UTP cat 5e information outlets toolless system 1 module	424	20/200
6730 55	UTP cat 6 - 1 module	630	20/200
6730 56	UTP cat 6 - 2 module	642	10/100

USB chargers (IS13252 (Part 1) / IEC 60950-1)

6730 80	USB Charger 1M 1000mA	1012	10/100
6731 78	Double USB Charger 2M 2400mA	1628	1/10/100

Audio & video connector

6730 57	3 x female RCA 1 module 1 module	2470	1/10
6730 58	3 pole XLR sockets 2 module	2384	10/100
6730 59	Female HD 15 - 2 module	2936	1/10

Sound (Volume controller)

6730 63	Suitable for 8 Ohms, 3 Watts (RNS) speaker - 2 module	1178	1/10/100
---------	---	------	----------

Protectors and accessories

Motor starter

6730 30	16 A motor starter 2 module	590	1/10/100
6730 31	25 A motor starter 2 module	604	1/10/100

Modular MCB (IS : 60898-1:2002)

6730 64	16A MCB SP 1M C curve	358	1/10/100
6730 65	20A MCB SP 1M C curve	358	1/10/100

RCBO

6730 78	Single pole + Neutral - 30 mA, 16 A - 230 VA 2 module	7862	1/1
---------	---	------	-----

* MRP - Maximum Retail Price Inclusive of all taxes including GST.

Bold Cat.Nos are products normally available with Legrand (India) Stockists. Cat.Nos that are not bold - delivery within 4 - 8 weeks from the date of order. Bold packing quantity is our mandatory packing. Orders to be placed by Legrand (India) Stockist in multiples of the same.

Myrius™ mechanisms - white

Cat.Nos	Description	MRP* ₹ / Unit	Pack
---------	-------------	---------------------	------

VSP

6730 70	Surge filter (VSP) - 230 V~ 1 module	2408	20/200
---------	---	------	--------

Accessories

6730 60	Cable outlet - 8 mm 1 module	226	20/200
6730 61	Blanking plate - 1 module	42	20/200
6730 62	Blanking plate - 2 module	46	10/100
0802 90	Panel mounting support 1 module	210	10/200
0802 91	Panel mounting support 2 module	216	10/200

Myrius antibacterial switches & accessories - white



6730 84	6 A switch 1 W - 1 module	170	20/200
6730 85	6 A switch 2 W - 1 module	226	20/200
6730 86	6 A bell push - 1 module	254	20/200
6730 89	16 A switch 1 way - 1 module	304	20/200
6730 90	16 A switch 2 way - 1 module	352	20/200
6730 92	Fan regulator 120 W - 2 module	1086	1/10/100
6730 93	Multistandard socket - 2 module	382	10/100
6730 94	6 A 5 pin universal socket 2 module	330	20/200
6730 95	6/16 A socket - 3 module	540	5/50
0787 00	Equipotential socket 1 module antibacterial	1566	1/10
6730 98	T.V. socket - 1 module	222	20/200
6730 99	RJ -11 telephone socket - 1 module	222	20/200
6730 81	RJ-45 Cat 6 UTP - 1 module	772	20/200
6730 82	Blanking plate - 1 module	42	20/200
6732 45	1 module plate + frame 1 module	154	20/200
6732 46	2 module plate + frame 2 module	172	20/200
6732 47	3 module plate + frame 3 module	182	10/100
6732 48	4 module plate + frame 4 module	198	10/100
6732 49	8 module plate + frame (horizontal) 8 module	378	5/50
6732 50	8 module plate + frame (4x2) 8 module	478	5/25
6732 52	16 module plate + frame 16 module	664	1/10

* MRP - Maximum Retail Price Inclusive of all taxes including GST.

Myrius™

Myrius Anti-bacterial



More for your wellness



Myrius anti-bacterial products offer anti-bacterial protection. The composition of the product contain Ag+ ions that eliminates the proliferation of bacteria on contact with the surface of the product. It has a smooth and straight design that facilitates in reducing the dust accumulation. It is self disinfecting throughout its lifespan.

- > Extremely useful in agri-food premises, healthcare environments & premises with high risk in terms of people's fragility.
- > Special protection for the health and hygiene market in the form of an equipotential socket for earthing devices, application to connection of hospital beds and trolleys to medical apparatus to avoid all risk of potential difference during the medical care.

Bold Cat.Nos are products normally available with Legrand (India) Stockists. Cat.Nos that are not bold - delivery within 4 - 8 weeks from the date of order. Bold packing quantity is our mandatory packing. Orders to be placed by Legrand (India) Stockist in multiples of the same.

Myrius™ mechanisms - black

Cat.Nos	Description	MRP* ₹ / Unit	Pack
---------	-------------	------------------	------

Switches – 6 A - 230 V~

6731 00	6 A switch 1 W 1 module	150	20/200
6731 01	6 A switch 2 W 1 module	214	20/200
6731 02	6 A switch 1 W with indicator - 1 module	234	20/200
6731 03	6 A switch 1 W with "Light" marking 1 module	180	20/200
6731 04	6 A switch 1 W with "Fan" marking 1 module	180	20/200



6731 01



6731 02

Switches – 10 A - 230 V~

6731 05	10 A switch 1 W 2 module	268	10/100
6731 06	10 A switch 2 W 2 module	288	10/100
6731 17	10 A intermediate switch 2 module	1656	10/100
6731 07	10 A switch 1 W with indicator - 2 module	306	10/100



6731 05

Switches – 16 A - 230 V~

6731 08	16 A switch 1 way 1 module	280	20/200
6731 09	16 A switch 2 way 1 module	338	20/200
6731 10	16 A switch 1 way with indicator - 1 module	352	20/200



6731 10

Switches – 20 A - 230 V~

6731 11	20 A 1 W switch 1 module	378	20/200
6731 12	20 A DP 1 W switch 2 module	588	10/100
6731 13	20 A DP 1 W switch with indicator - 2 module	624	10/100
6731 14	20 A 2 W switch 2 module	644	10/100



6731 12

Switches – 25 A - 230 V~

6731 15	25 A SP 1 W switch with indicator - 1 module	430	20/200
---------	--	-----	--------



6731 15

Switches – 32 A - 230 V~

6731 16	32 A DP switch with indicator - 2 module	962	10/100
---------	--	-----	--------

Myrius™ mechanisms - black

Cat.Nos	Description	MRP* ₹ / Unit	Pack
---------	-------------	------------------	------

Push buttons

6731 18	6 A push button SP 1 module	248	20/200
6731 19	6 A push button SP with indicator - 1 module	312	20/200
6731 20	6 A bell push - 1 module	234	20/200
6731 21	6 A bell push with indicator - 1 module	312	20/200
6731 22	6 A bell push 2 module	362	10/100
6731 23	6 A bell push with indicator - 2 module	430	10/100



6731 21



6731 22

Accessories for switches with indicator

6732 44	Lamp for switches / push buttons	46	5/50
---------	-------------------------------------	----	------

Socket - black

6731 41	6/16 A 2 pin Euro US socket - 1 module	336	20/200
6731 42	16 A 3 pin switched socket - 3 module	1084	5/50
6731 43	Multistandard socket 6/10/13 A - 2/3 pin for 250 V AC 15 A for 127 V type - 2 pin 2 module	372	10/100
6731 44	6 A 5 Pin with universal socket 2 module	302	20/200
6731 83	6/16 A socket 3 module	510	5/50
6731 45	6/16 A socket 2 module	432	10/100
6731 46	6/16 A - Euro socket 2 module	486	10/100
6731 47	25 A socket - 2 module	530	10/100



6731 41



6731 42



6731 44

Socket - red

6730 48	16 A switched socket 3 module	964	5/50
---------	----------------------------------	-----	------



6730 48

Dimmers & regulators

6731 24	Rotary dimmer 400 W 1 module	1050	1/5/50
6731 25	Rotary dimmer 650 W 3 module	2220	1/10
6731 26	Compact Fluo - 2 module lamp dimmer (Universal load)	2932	1/10
6731 27	Fan step regulator 100 W 1 module	822	1/5/50
6731 29	Fan step regulator 100 W 2 module	930	1/10/100
6731 28	Fan step regulator 120 W 2 module	1022	1/10/100
6731 77	Fan step regulator - 2 module for energy saving fans	990	1/10/100



6731 25



6731 27

* MRP - Maximum Retail Price Inclusive of all taxes including GST.

Bold Cat.Nos are products normally available with Legrand (India) Stockists. Cat.Nos that are not bold - delivery within 4 - 8 weeks from the date of order. Bold packing quantity is our mandatory packing. Orders to be placed by Legrand (India) Stockist in multiples of the same.

Myrius™ mechanisms - black

Cat.Nos	Description	MRP* ₹ / Unit	Pack
---------	-------------	------------------	------

Skirting light

6731 36	Skirting light with white LED - 3 module	798	1/5/25
---------	--	-----	--------

Bell indicator

6731 33	Bell Indicator- 240 V~ 1 module	1170	20/200
---------	------------------------------------	------	--------

Buzzer

6731 34	Buzzer - 230 V~ sound level 72dB at 1 meter distance 1 module	1136	20/200
---------	--	------	--------

Remote unit

6731 73	Remote control switch 4 module	8444	1/5/20
---------	-----------------------------------	------	--------

Hospitality functions

Key FOB switch

6731 37	15 A key card switch with timedelay 30 sec. monobloc with plate - 2 M	3806	1/10
6732 67	15 A key card switch monobloc with new plate - 2 M Black	4188	1/10
6730 38	Only key fob for switch Cat.No 6731 37 & 6732 67	158	1/10/100

"Do Not Disturb" and MMR control unit

6731 39	External unit - 1+1 module	1618	10/100
6731 40	Internal unit - 1+1 module	1082	10/100

Shaver socket

6731 49	Shaver socket 220/240 V - 50/60 Hz monobloc with plate - 4 M	4566	1/5/20
6731 79	Shaver socket 230 V / 120 - 230 V monobloc with new plate - 4 M Black	4808	1/5

TV socket

6731 50	TV socket - 1 module	222	20/200
6731 51	TV / Sat / FM shielded sockets 0 - 2400 MHz - 2 module	1846	10/100

Data & voice

6731 52	RJ-11 telephone socket with transparent shutter 1 module	214	20/200
6731 53	RJ-11 double telephone socket with shutter 1 module	326	20/200

Myrius™ mechanisms - black

Cat.Nos	Description	MRP* ₹ / Unit	Pack
---------	-------------	------------------	------

Data & voice

6731 54	UTP cat 5e RJ 45 information outlets 1 module	466	20/200
6731 55	UTP cat 6 - 1 module	712	20/200
6731 56	UTP cat 6 - 2 module	720	10/100

USB chargers (IS13252 (Part 1) / IEC 60950-1)

6731 80	USB Charger 1M 1000mA	1162	10/100
6732 78	Double USB Charger 2M 2400mA	1872	1/10/100

Connectors and controllers

Audio & video connector

6731 57	3 x female RCA -1 module	2844	1/10
6731 58	3 pole XLR sockets 2 module	2686	10/100
6731 59	Female HD 15 - 2 module	3374	1/10

Sound

6731 63	Suitable for 8 Ohms, 8 Ohms, 3 Watts (RNS) speaker - 2 module	1366	1/10/100
---------	---	------	----------

Protectors and accessories

Motor starter

6731 30	16 A motor starter- 2 module	678	1/10/100
6731 31	25 A motor starter- 2 module	694	1/10/100

Modular MCB (IS : 60898-1:2002)

6731 64	16A MCB SP 1M C curve	410	1/10/100
6731 65	20A MCB SP 1M C curve	410	1/10/100

VSP

6731 70	Surge filter (VSP) - 230 V~ - 1 module	2782	20/200
---------	---	------	--------

Accessories

6731 60	Cable outlet - 8mm 1 module	268	20/200
6731 61	Blanking plate-1 module	44	20/200

Plastic plates

White plates with frame

6732 01	1 Module plate + Frame	132	20/200
6732 02	2 Module plate + Frame	140	20/200
6732 03	3 Module plate + Frame	148	10/100
6732 04	4 Module plate + Frame	162	10/100
6732 06	6 Module plate + Frame	288	5/50
6732 08	8 Module plate + Frame (horizontal)	314	5/50
6732 09	8 Module plate + Frame (4x2)	396	5/25
6732 12	12 Module plate + Frame	476	1/10
6732 16	16 Module plate + Frame	556	1/10
6732 18	18 Module plate + Frame	638	1/10

Bold Cat.Nos are products normally available with Legrand (India) Stockists. Cat.Nos that are not bold - delivery within 4 - 8 weeks from the date of order. Bold packing quantity is our mandatory packing. Orders to be placed by Legrand (India) Stockist in multiples of the same.

Myrius™ plastic plates

Cat.Nos	Description	MRP* ₹ / Unit	Pack
---------	-------------	------------------	------

New white plates with frame*

6732 11	1 Module plate + Frame	148	20/200
6732 42	2 Module plate + Frame	156	20/200
6732 13	3 Module plate + Frame	174	10/100
6732 14	4 Module plate + Frame	182	10/100
6732 66	6 Module plate + Frame	340	5/50
6732 68	8 Module plate + Frame (Horizontal)	362	5/50
6732 69	8 Module plate + Frame (4x2)	452	5/25
6732 62	12 Module plate + Frame	548	1/10
6732 56	16 Module plate + Frame	642	1/10
6732 58	18 Module plate + Frame	734	1/10

Black plates with frame

6732 21	1 Module plate + Frame	222	20/200
6732 22	2 Module plate + Frame	242	20/200
6732 23	3 Module plate + Frame	254	10/100
6732 24	4 Module plate + Frame	284	10/100
6732 26	6 Module plate + Frame	492	5/50
6732 28	8 Module plate + Frame (Horizontal)	546	5/50
6732 29	8 Module plate + Frame (4 x 2)	674	5/25
6732 32	12 Module plate + Frame	808	1/10
6732 36	16 Module plate + Frame	950	1/10
6732 38	18 Module plate + Frame	1074	1/10

New black plates with frame*

6732 31	1 Module plate + Frame	252	20/200
6732 82	2 Module plate + Frame	278	20/200
6732 33	3 Module plate + Frame	296	10/100
6732 34	4 Module plate + Frame	326	10/100
6732 86	6 Module plate + Frame	570	5/50
6732 88	8 Module plate + Frame (Horizontal)	622	5/50
6732 89	8 Module plate + Frame (4 x 2)	780	5/25
6732 92	12 Module plate + Frame	934	1/10
6732 96	16 Module plate + Frame	1090	1/10
6732 98	18 Module plate + Frame	1232	1/10

Mounting boxes

Flush mounting boxes

6890 07	Flush box - 1/2 module	98	40
6890 08	Flush box - 3 module	98	40
6890 09	Flush box - 4 module	132	40
6890 10	Flush box - 6 module	206	40
6890 42	Flush box - 8 module	242	40
6890 31	Flush box - 8 module (2 row x 4)	240	20
6890 11	Flush box - 12/16 (2 row x 6) module (metal box)	364	10
6890 12	Flush box - 18 module (metal box)	458	10

* MRP - Maximum Retail Price Inclusive of all taxes including GST.
The new plate range will be introduced shortly.

Myrius™ mounting boxes

Cat.Nos	Description	MRP* ₹ / Unit	Pack
---------	-------------	------------------	------

Surface mounting boxes

6733 02	Surface box - 1/2 module	66	10/50
6733 03	Surface box - 3 module	80	5/35
6733 04	Surface box - 4 module	92	5/25
6733 06	Surface box - 6 module	118	1/10
6733 08	Surface box - 8 module	174	1/5
6733 05	Surface box - 8 (2 row x 4) module	168	1/5

Metal surface boxes

6890 21	Metal surface box - 12/16 (2 row x 6) module	418	1/6
6890 22	Metal surface box - 18 module	440	1/4

Myrius™

More is on.

Guarantee

- The Company, at its discretion, will replace products if they have any manufacturing defect within 10 years for switches (without LED lamp) and power sockets. For all other **Myrius™** wiring accessories the guarantee will be 2 years.
- The above guarantee is applicable when the devices are used in Legrand metal flush boxes. Otherwise the guarantee period will be reduced by 50%.
- The guarantee is only applicable when the products are installed as per the Company's instructions and not tampered in any manner.
- The guarantee states the Company's entire liability. It does not extend to cover consequential loss or damage or installation costs arising from defective products.

Bold Cat.Nos are products normally available with Legrand (India) Stockists. Cat.Nos that are not bold - delivery within 4 - 8 weeks from the date of order. Bold packing quantity is our mandatory packing. Orders to be placed by Legrand (India) Stockist in multiples of the same.

Mylinc™

A little touch of genius

Mylinc™ is a complete range of modular wiring accessories. Switches and sockets designed and made in India, keeping everyone's requirements in mind. Whether it's safety, reliability, convenience or beauty; Mylinc™ is the smart option in modular switch design.



USB Charger



360° Fan regulator



Remote control unit for Light and Fan



Modular MCB



Champagne



Silver Alu



Dark Bronze



Matt Grey



Pearl White



Motor Starter



Skirting Light 2 M



Switch 25 A with indicator

Mylic™ mechanisms

Cat.Nos	Description	MRP* ₹ / Unit	Pack
---------	-------------	------------------	------

Switches and accessories

Switches 6 A - 250 V AC

6755 01	6 A one-way SP switch - 1 module	86	20/200
6755 02	6 A two-way SP switch - 1 module	146	20/200
6755 03	6 A one-way SP switch with indicator - 1 module	168	20/200

Switches 16 A - 250 V AC

6755 11	16 A one-way SP switch - 1 module	162	20/200
6755 12	16 A two-way SP switch - 1 module	204	20/200
6755 13	16 A one-way SP switch with indicator - 1 module	212	20/200

Switch 25 A - 250 V AC

6759 68	Switch 25 A with indicator - 1 module	254	10/100
---------	--	-----	--------

Switches 32 A - 250 V AC

6755 26	32 A one-way double pole switch with indicator - 2 module	490	10/100
---------	--	-----	--------

Push buttons 6 A - 250 V AC

6755 04	6 A one-way SP bell push - 1 module	152	20/200
6755 06	6 A one-way SP bell push with indicator - 2 module	306	10/100

Bell call indicator & register - 6 A - 250 V AC

6755 07	Bell call Indicator with register - 6 A - one-way - SP - 1 module	814	20/200
---------	--	-----	--------

Lighting modules

6755 95	Indicator light red - 1 module	182	20/200
6755 96	Indicator light orange - 1 module	182	20/200
6755 97	Skirting light with white LED - 3 module	608	1/5/25
6759 76	Skirting light with white LED - 2 module	412	5/50

Dimmers and fan regulators

6755 35	Rotative dimmer 60 - 250 W for light - 2 module	512	1/10/100
6755 33	Mylic dimmer 400 W for light - 1 module	652	1/5/50
6759 64	Fan regulator 100 W with 360° rotation - 2 module	580	10/100
6755 30	Fan regulator 100 W, Humfree, 0-4 steps - 2 module	622	1/10/100
6755 31	Fan regulator 100 W, Humfree, 0-4 steps - 1 module	468	1/5/50
6759 77	Fan regulator 8 steps - 2 module	622	1/10/100

Mylic™ mechanisms

Cat.Nos	Description	MRP* ₹ / Unit	Pack
---------	-------------	------------------	------

Buzzer

6755 40	Mylic buzzer	548	20/200
---------	--------------	-----	--------

Remote unit

6759 75	Remote control unit with remote for 4 switch & fan load 4 m	3078	1/5/20
---------	---	------	--------

DND & MMR

Indicator lamp

6755 56	DND & MMR external unit with bellpush 3 m	288	10/50
6759 69	DND & MMR external unit with bellpush 1+1 - 2 m	288	10/100
6755 57	Mylic internal control unit for DND & MMR	238	10/100

Hotel key fob switch

6755 60	Hotel key fob switch - monobloc	2648	1/10
6730 38	Only key fob for 6755 60	158	1/10

Energy sockets / power unit

Energy sockets

6755 50	6 A - 2/3 pin combine - 2 module	172	10/100
6755 55	6/16 A - 3 pin combine - 2 module	280	10/100
6755 51	6 A - 3 pin - 2 module	188	10/100
6755 52	Universal socket 6 A - 2/3 pin combine - 2 module	214	10/100
6755 53	Euro US socket 6/16 A - 2 pin, 1 module	266	20/200
6755 54	6/10/13 A - multistandard socket - 2 Module	282	10/100

Power unit

6755 58	Power unit for 2 ton A.C and 3.5 KW geyser - 4 module	1002	5/25
---------	--	------	------

Motor starter

6759 65	Motor starter 16 A 2 m	468	1/10/100
---------	------------------------	-----	----------

Modular MCB (IS : 60898-1:2002)

6759 74	Modular SP MCB 16 A 1 m	302	1/10/100
---------	-------------------------	-----	----------

Low voltage sockets / TV socket and RJ11 telephone socket / accessories

Sockets

6755 46	TV socket 1 module	152	20/200
6755 41	RJ 11 telephone socket 1 module	142	20/200
6755 44	Double RJ 11 telephone socket 1 module	240	20/200
6759 66	RJ45 socket cat 5e with shutter - 1 module	386	20/200
6759 67	RJ45 socket cat 6 with shutter - 1 module	538	20/200

* MRP - Maximum Retail Price Inclusive of all taxes including GST.

Bold Cat.Nos are products normally available with Legrand (India) Stockists. Cat.Nos that are not bold - delivery within 4 - 8 weeks from the date of order. Bold packing quantity is our mandatory packing. Orders to be placed by Legrand (India) Stockist in multiples of the same.

Mylic™ mechanisms

Cat.Nos	Description	MRP* ₹ / Unit	Pack
---------	-------------	------------------	------

USB chargers (IS13252(Part 1) / IEC 60950-1)

6759 71	USB charger - 1 module	664	10/100
6759 72	Double USB charger - 2 module	1092	10/100

Accessories

6755 91	Cable outlet - 1 module	134	20/200
6755 90	Blanking plate 0.8 mm - 1 module	34	20/200
6755 92	Spare 12 screws with nuts	50	20/200

Mylic™ plates

Modular white plates with frame

6755 61	1 module plate - white	92	20/200
6755 62	2 modules plate - white	92	20/200
6755 63	3 modules plate - white	122	10/100
6755 64	4 modules plate - white	140	10/100
6755 66	6 modules plate - white	174	5/50
6755 67	8 modules horizontal - white	224	5/50
6755 68	4x2 modules plate - white	230	5/25
6755 69	9 modules plate- white	266	5/50
6755 72	12 modules plate - white	326	10
6755 73	16 modules plate - white	378	10
6755 78	18 modules plate - white	506	10

Mylic™ mechanism matt grey

Switches and accessories

Switches 6 A - 250 V AC

6763 01	6 A one-way SP switch - 1 module	102	20/200
6763 02	6 A two-way SP switch - 1 module	160	20/200
6763 03	6 A one-way SP switch with indicator - 1 module	188	20/200

Switches 16 A - 250 V AC

6763 11	16 A one-way SP switch 1 module	180	20/200
6763 12	16 A two-way SP switch 1 module	224	20/200
6763 13	16 A one-way SP switch with indicator 1 module	238	20/200

Switch 25 A - 250V AC

6763 41	Switch 25 A with indicator - 1 module	282	10/100
---------	--	-----	--------

Switches 32 A - 250V AC

6763 26	32 A one-way double pole switch with indicator - 2 module	538	20/200
---------	--	-----	--------

Push buttons 6 A - 250 V AC

6763 04	6 A one-way SP bell push 1 module	162	20/200
6763 06	6 A one-way SP bell push with indicator 2 module	334	10/100

* MRP - Maximum Retail Price Inclusive of all taxes including GST.

Mylic™ mechanism matt grey

Cat.Nos	Description	MRP* ₹ / Unit	Pack
---------	-------------	------------------	------

Bell call indicator & register - 6 A - 250 V AC

6763 07	Bell call indicator with register - 6 A - one way 1 module	898	20/200
---------	---	-----	--------

Lighting modules

6763 14	Indicator light red 1 module	198	20/200
6763 15	Indicator light orange 1 module	198	20/200
6763 16	Skirting light with white LED - 3 module	670	1/5/25
6763 10	Skirting light with white LED - 2 module	454	5/50

Dimmers and fan regulators

6763 17	Rotative dimmer 60 - 250 W for light 2 module	564	1/10/100
6763 18	Rotative dimmer 60 - 400 W 1 module	718	1/5/50
6763 37	Fan regulator 100 W, with 360° rotation 2 module	636	10/100
6763 19	Fan regulator 4 step 2 module	686	1/10/100
6763 20	Fan regulator 4 step 1 module	512	1/5/50
6763 08	Fan regulator 8 step 2 module	682	1/10/100

Buzzer

6763 21	Mylic buzzer	600	20/200
---------	--------------	-----	--------

Remote unit

6763 47	Remote control unit with remote for 4 switch & fan load 4 m	3388	1/5/20
---------	---	------	--------

DND & MMR

Indicator lamp

6763 42	DND & MMR external unit with bellpush 1+1	320	10/100
6763 23	Mylic internal control unit for DND & MMR	264	10/100

Hotel key fob switch

6730 38	Only key fob for 6755 60	158	1/10
6763 24	Hotel key fob switch monobloc	2910	1/10

Energy sockets / power unit

Energy sockets

6763 25	6 A - 2/3 pin combined	194	10/100
6763 05	6/16A - 3 pin Combined 2 module	304	10/100
6763 27	6 A - 3 pin - 2 module	204	10/100
6763 28	Universal socket 6A-2/3 pin combined 2 module	238	10/100

Bold Cat.Nos are products normally available with Legrand (India) Stockists. Cat.Nos that are not bold - delivery within 4 - 8 weeks from the date of order. Bold packing quantity is our mandatory packing. Orders to be placed by Legrand (India) Stockist in multiples of the same.

Mylic™ mechanism matt grey

Cat.Nos	Description	MRP* ₹ / Unit	Pack
---------	-------------	------------------	------

Energy sockets / power unit

Energy sockets

6763 29	Euro US socket 6/16A - 2 pin 1 module	296	20/200
6763 30	6/10/13 A - Multistandard socket 2 module	308	10/100

Power unit

6763 31	Power unit for 2 ton A.C and 3.5 KW geyser - 4 module	1100	5/25
---------	--	------	------

Motor starter

6763 38	Motor starter 16 A 2 m	516	1/10/100
---------	------------------------	-----	----------

Modular MCB (IS : 60898-1:2002)

6763 46	Modular SP MCB 16 A 1 m	336	1/10/100
---------	----------------------------	-----	----------

Low voltage sockets / TV socket and RJ11 telephone socket / accessories

Sockets

6763 32	TV socket - 1 module	162	20/200
6763 33	RJ 11 telephone 1 module	156	20/200
6763 34	Double RJ 11 telephone socket 1 module	260	20/200
6763 39	RJ 45 socket cat 5e with shutter 1 module	422	20/200
6763 40	RJ 45 socket cat 6 with shutter 1 module	590	20/200

USB chargers (IS13252(Part 1) / IEC 60950-1)

6763 43	USB charger 1 module	728	10/100
6763 44	Double USB charger 2 module	1202	1/10/100

Accessories

6763 48	Cable outlet 1 module	148	20/200
6763 49	Blanking plate 0.8 mm 1 module	36	20/200

Mylic™ plates

Modular Matt Grey plates with frame

6763 50	Matt grey plate 1 m	120	20/200
6763 51	Matt grey plate 2 m	120	20/200
6763 52	Matt grey plate 3 m	164	10/100
6763 53	Matt grey plate 4 m	176	10/100
6763 54	Matt grey plate 6 m	224	5/50
6763 55	Matt grey plate 8 m horizontal	296	5/50
6763 56	Matt grey plate 4x2 m	296	5/25
6763 57	Matt grey 9 m	344	5/50
6763 58	Matt grey plate 12 m	420	10
6763 59	Matt grey plate 18 m	664	10

* MRP - Maximum Retail Price Inclusive of all taxes including GST.

Modular colour plates with frame

Cat.Nos	Description	MRP* ₹ / Unit	Pack
---------	-------------	------------------	------

Pearl white cover plates

6763 60	Pearl white plate 1 m	112	10/100
6763 61	Pearl white plate 2 m	112	10/100
6763 62	Pearl white plate 3 m	152	10/100
6763 63	Pearl white plate 4 m	162	10/100
6763 64	Pearl white plate 6 m	210	5/50
6763 65	Pearl white 8 m plate horizontal	268	5/50
6763 66	Pearl white plate 4x2 m	272	5/25
6763 67	Pearl white plate 9 m	316	5/50
6763 68	Pearl white plate 12 m	390	5/25
6763 69	Pearl white plate 18 m	610	5/25

Champagne cover plates

6763 70	Champagne plate 1 m	112	10/100
6763 71	Champagne plate 2 m	112	10/100
6763 72	Champagne plate 3 m	152	10/100
6763 73	Champagne plate 4 m	162	10/100
6763 74	Champagne plate 6 m	210	5/50
6763 75	Champagne plate 8 m horizontal	268	5/50
6763 76	Champagne plate 4x2 m	272	5/25
6763 77	Champagne plate 9 m	316	5/50
6763 78	Champagne plate 12 m	390	5/25
6763 79	Champagne plate 18 m	610	5/25

Silver alu cover plates

6763 80	Silver alu plate 1 m	112	10/100
6763 81	Silver alu plate 2 m	112	10/100
6763 82	Silver alu plate 3 m	152	10/100
6763 83	Silver alu plate 4 m	162	10/100
6763 84	Silver alu plate 6 m	210	5/50
6763 85	Silver alu plate 8 m horizontal	268	5/50
6763 86	Silver alu plate 4x2 m	272	5/25
6763 87	Silver alu plate 9 m	316	5/50
6763 88	Silver alu plate 12 m	390	5/25
6763 89	Silver alu plate 18 m	610	5/25

Dark bronze cover plates

6763 90	Dark bronze plate 1 m	112	10/100
6763 91	Dark bronze plate 2 m	112	10/100
6763 92	Dark bronze plate 3 m	152	10/100
6763 93	Dark bronze plate 4 m	162	10/100
6763 94	Dark bronze plate 6 m	210	5/50
6763 95	Dark bronze plate 8 m horizontal	268	5/50
6763 96	Dark bronze plate 4x2 m	272	5/25
6763 97	Dark bronze plate 9 m	316	5/50
6763 98	Dark bronze plate 12 m	390	5/25
6763 99	Dark bronze plate 18 m	610	5/25

Bold Cat.Nos are products normally available with Legrand (India) Stockists. Cat.Nos that are not bold - delivery within 4 - 8 weeks from the date of order. **Bold packing quantity** is our mandatory packing. Orders to be placed by Legrand (India) Stockist in multiples of the same.

Mylinc™ boxes



Cat.Nos	Description	MRP* ₹ / Unit	Pack
---------	-------------	------------------	------

Modular white surrounds

6755 81	1 module	40	20/200
6755 82	2 modules	64	20/200
6755 83	3 modules	64	10/100
6755 84	4 modules	98	10/100
6755 86	6 modules (2 column x 3)	140	10/100
6755 89	9 modules (3 column x 3)	244	10/100

Metal flush boxes

6890 07	Flush box - 1/2 modules	98	40
6890 08	Flush box - 3 modules	98	40
6890 09	Flush box - 4 modules	132	40
6890 10	Flush box - 6 modules	206	40
6890 42	Flush box - 8 modules	242	40
6890 31	Flush box - 4 x 2 modules	240	20
6890 29	Flush box - 9 modules	282	20
6890 11	Flush box - 12 modules	364	10
6890 13	Flush box - 16 modules	416	10
6890 12	Flush box - 18 modules	458	10

Plastic surface boxes

6733 02	Surface box- 1/2 modules	66	10/50
6733 03	Surface box- 3 modules	80	5/35
6733 04	Surface box- 4 modules	92	5/25
6733 06	Surface box- 6 modules	118	1/10
6733 08	Surface box- 8 modules	174	1/5
6733 05	Surface box- 4 x 2 modules	168	1/5
6740 99	Surface box- 9 modules	198	1/5

Metal surface boxes

6890 21	Metal surface box- 12 modules (2 rows x 6)	418	1/6
6890 22	Metal surface box- 18 modules (3 rows x 6)	440	1/4



Screwless finish & rounded corners



Linc-Loc™



Shockproof sockets- Childsafe

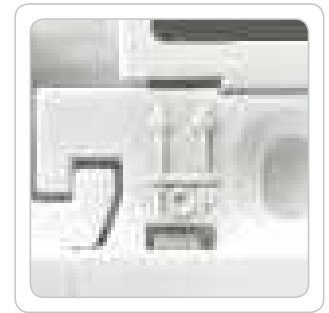

Top orientation arrow



Stripping Template

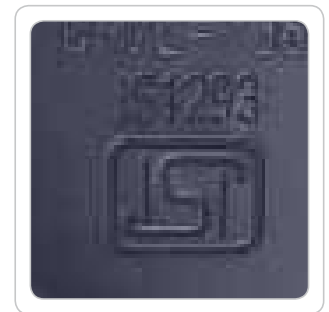

ISI marking

Mylinc™
A little touch of genius

Guarantee

- The Company, at its discretion, will replace products if they have any manufacturing defect within 10 years for switches (without LED lamp) and power sockets. For all other Mylinc™ wiring accessories the guarantee will be 2 years.
- The above guarantee is applicable when the devices are used in Legrand metal flush boxes. Otherwise the guarantee period will be reduced by 50%.
- The guarantee is only applicable when the products are installed as per the Company's instructions and not tampered in any manner.
- The guarantee states the Company's entire liability. It does not extend to cover consequential loss or damage or installation costs arising from defective products.

* MRP - Maximum Retail Price Inclusive of all taxes including GST.

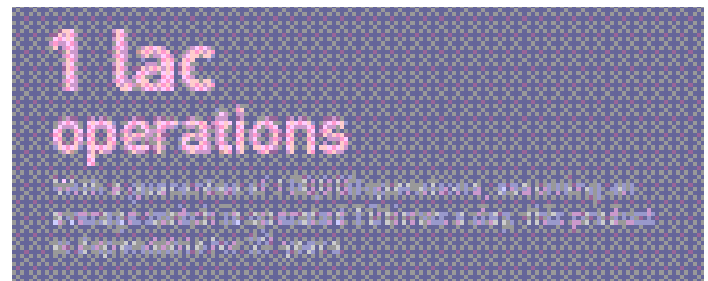

Bold Cat.Nos are products normally available with Legrand (India) Stockists. Cat.Nos that are not bold - delivery within 4 - 8 weeks from the date of order. Bold packing quantity is our mandatory packing. Orders to be placed by Legrand (India) Stockist in multiples of the same.



Laser marking



Front Removal



CE marking

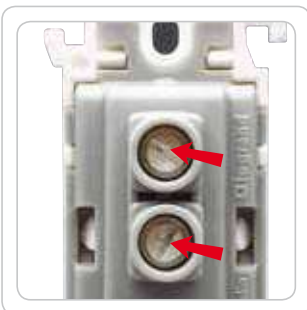

Finger-proof terminals
for IP 20 protection
against accidental contact

Mylinc™

A little touch of genius

LyncusTM
Change to Today



TIME TO CHANGE TO TODAY

Today's homes need a range that mirrors their look. A modern sleek look with clean lines. A look that is chic and futuristic. Our new Lyncus range brings the aesthetic to your home, but with a subtle touch that adds character to every room.

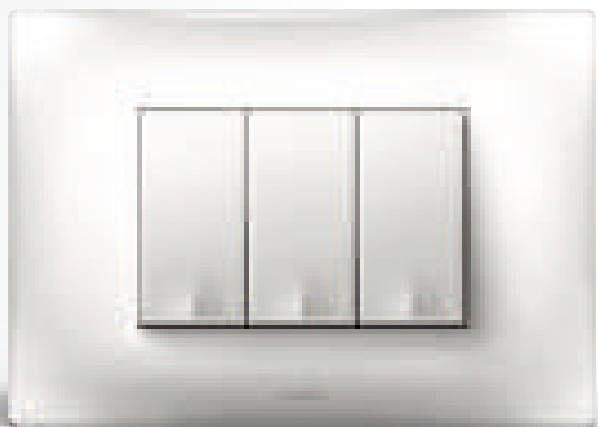

White



Chic Grey

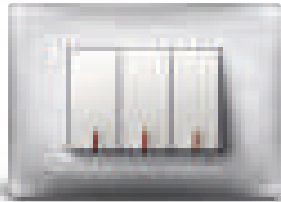

Brushed

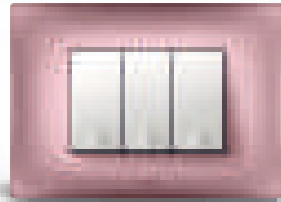

Alu Sunset

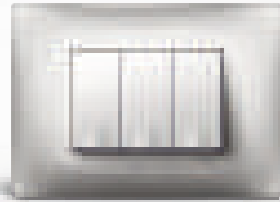

Champagne

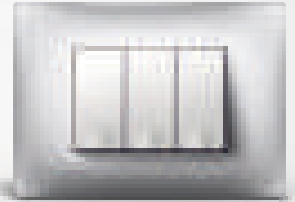

Matt Silver

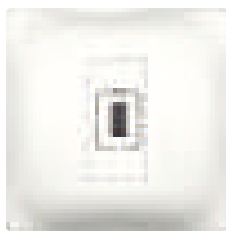

USB TYPE C



USB TYPE A + TYPE C

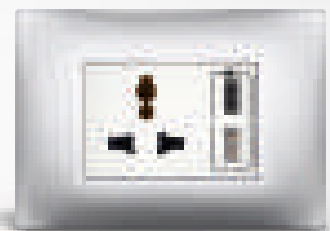

COMBI TWIN USB

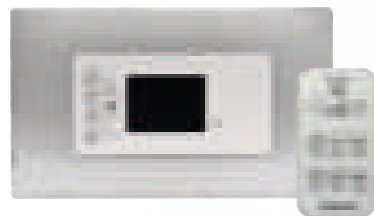

REMOTE CONTROL UNIT

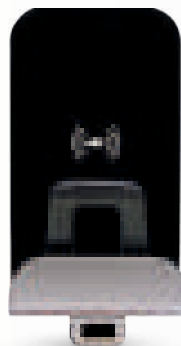

INDUCTION CHARGER

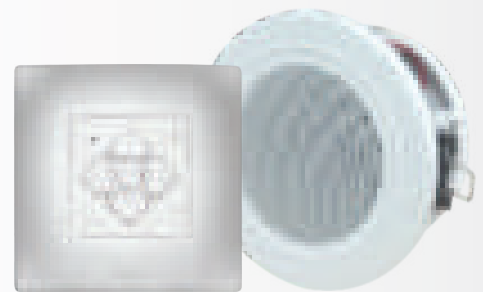

BLUETOOTH SOUND RECEIVER

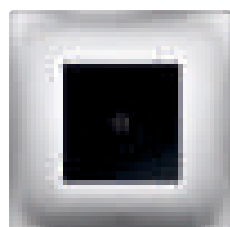

ONE WAY
TOUCH SWITCH

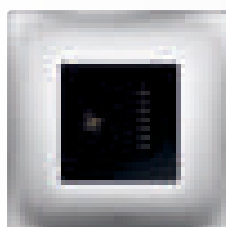

TOUCH FAN
REGULATOR

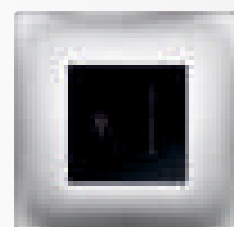

UNIVERSAL
TOUCH DIMMER

Lyncus™ mechanisms white

NEW!

Cat.Nos	Description	MRP* ₹ / Unit	Pack
---------	-------------	------------------	------

Switches 6A 230V AC

6772 00	6 A Switch 1 W 1 module	76	20/200
6772 01	6 A Switch 2 W 1 module	132	20/200
6772 02	6 A Switch 1 W 1 module with indicator	132	20/200
6772 03	6 A Switch 1 W 1 module with "Light" marking	124	20/200
6772 04	6 A Switch 1 W 1 module with "Fan" marking	124	20/200

Switches 10A 230V AC

6772 05	10 A Switch 1 W 2 module	160	10/100
6772 06	10 A Switch 2 W 2 module	188	10/100
6772 07	10 A Intermediate switch 2 module	1064	10/100
6772 08	10 A Switch 1 W with indicator 2 module	204	10/100

Switches 16A 230V AC

6772 09	16 A Switch 1 W 1 module	146	20/200
6772 10	16 A Switch 2 W 1 module	184	20/200
6772 11	16 A Switch 1 W with indicator 1 module	190	20/200

Switches 20A 230V AC

6772 12	20 A Switch 1 W 1 module	222	20/200
6772 13	20 A DP Switch 1 W 2 module	322	10/100
6772 14	20 A DP Switch 1 W with indicator 2 module	328	10/100
6772 15	20 A Switch 2 way 2 module	366	10/100

Switches 25A 230V AC

6772 16	25 A SP 1 W Switch with indicator 1 module	230	20/200
---------	--	-----	--------

Switches 32A 230V AC

6772 17	32 A DP Switch with indicator 2 module	442	10/100
---------	--	-----	--------

Push button 6A 230V AC

6772 18	6 A Push button SP 1 module	106	20/200
6772 19	6 A Push button SP with indicator 1 module	152	20/200
6772 20	6 A Bell push 1 module	138	20/200
6772 21	6 A Bell push with indicator 1 module	166	20/200
6772 22	6 A Bell push 2 module	184	10/100
6772 23	6 A Bell push with indicator 2 module	274	10/100

Accessories for switches

6772 24	LED Indicator for switches	28	5/50
---------	----------------------------	----	------

Socket 240 V AC

6772 25	6/16 A 2 Pin Euro US socket 1 module	236	20/200
6772 26	16 A 3 Pin Switched socket 3 module	462	5/50
6772 27	Multistandard socket 6/10/13 A 2/3 Pin for 250 VAC 15 A for 127 V type 2 Pin 2 module	246	10/100
6772 28	6 A 5 Pin Universal socket 2 module	188	20/200
6772 29	6/16 A Socket 3 module	288	5/50
6772 30	6/16 A Socket 2 module	244	10/100
6772 31	6/16 A Euro Socket 2 module	250	10/100
6772 32	25 A Socket 2 module	250	10/100

* MRP - Maximum Retail Price Inclusive of all taxes including GST.
Red Cat.Nos - new products

Lyncus™ mechanisms white

NEW!

Cat.Nos	Description	MRP* ₹ / Unit	Pack
---------	-------------	------------------	------

Dimmers and fan regulators

6772 36	Rotary light dimmer 400 W 1 module	446	5/50
6772 37	Rotary light dimmer 500 W 2 module	568	10/100
6772 39	Fan regulator 100 W 1 module	408	5/50
6772 40	Fan regulator 100 W 360 degree 2 module	504	10/100
6772 41	Fan regulator 120 W 360 degree 2 module	574	10/100
6772 42	Fan step regulator 70 W 2 module	552	10/100

Emergency light

6772 43	Removable LED lamp 2 module	2000	1/12
---------	-----------------------------	------	------

Skirting light

6772 48	LED skirting light 3 module	370	5/25
---------	-----------------------------	-----	------

Indicator

6772 87	Indicator unit 1 module with transparent led & colored labels	646	10/100
---------	---	-----	--------

Bell call indicator

6772 49	Bell call indicator 240 V 1 module	734	20/200
---------	------------------------------------	-----	--------

Buzzer

6772 50	Buzzer 230 V 1 module	492	20/200
---------	-----------------------	-----	--------

Infrared Sensors

6772 51	Infrared sensor 400 W 2 module	1296	1/50
---------	--------------------------------	------	------

Remote unit

6772 52	Remote control unit for light & fan 4 module	2770	5/20
6773 03	Remote control hand unit	518	5/30

Hospitality function

Hotel keycard switch

6772 53	16 A Key card switch 2 module	2382	1/10
6772 55	Credit card size key fob	86	10/100

Hotel "DND and MMR" functions

6772 56	DND & MMR indicator with bell push 1+1 module	260	10/100
6772 57	Internal control unit for DND & MMR 1+1 module	216	10/100

Shaver socket

6772 58	Shaver socket 120/240 V MonoBlock with plate 2 module	1814	1/16
---------	---	------	------

Sockets and connectors

TV sockets

6772 60	TV Coaxial socket 1 module	138	20/200
---------	----------------------------	-----	--------

Data & voice

6772 62	Telephone socket RJ11 1 module	128	20/200
---------	--------------------------------	-----	--------

Bold Cat.Nos are products normally available with Legrand (India) Stockists. Cat.Nos that are not bold - delivery within 4 - 8 weeks from the date of order. Bold packing quantity is our mandatory packing. Orders to be placed by Legrand (India) Stockist in multiples of the same.

Lyncus™ sockets and connectors

NEW!

Cat.Nos	Description	MRP* ₹ / Unit	Pack
---------	-------------	------------------	------

Data & voice

6772 63	Telephone socket double RJ11 1 module	216	20/200
6772 64	RJ 45 UTP cat 5 tooless with shutter 1 M white	366	20/200
6772 65	RJ 45 UTP cat 6 tooless with shutter 1 M white	512	20/200

Audio video connectors

6772 67	Preterminated audio video connector 1 module	1244	1/10
6772 68	Preterminated HDMI socket 1 module	1526	1/10
6772 69	Preterminated projector connector 1 module	1526	1/10

Sound (Volume controller)

6772 70	Volume controller 2 module	828	10/100
---------	----------------------------	-----	--------

Protectors and accessories

Motor starter

6772 71	16 A Motor starter 2 module	468	10/100
6772 72	25 A Motor starter 2 module	468	10/100

VSP

6772 74	Voltage surge protector 230 V 1 module	1482	20/200
---------	--	------	--------

Modular MCB (IS : 608981:2002)

6772 81	16 A MCB SP 1 M C curve	310	10/100
6772 82	20 A MCB SP 1 M C curve	310	10/100
6772 83	32 A MCB SP 1 M C curve	310	10/100

Electronic function

USB chargers (IS13252 (Part 1) / IEC 60950-1)

6772 88	USB Charger 1000 mA 1 module type A	596	5/50
6772 89	Double USB charger 3000 mA 2 module type A & type C	1820	10/100
6772 90	USB Charger 1500 mA 1 module type C	876	5/50

Combi (Socket + USB)

6772 92	Combi twin USB 2400 mA multistandard socket type A	2100	5/50
6772 94	Combi twin USB 2400 mA multistandard socket type A & type C	2310	5/50

Wireless charger**

6772 95	Wireless charger + type-A USB 1 A - 5 V / 5 W charger with one 2.4 A/12 W USB port to power a second device	5704	1/10
---------	---	------	------

Loud speakers

6772 98	Loudspeaker for false ceiling & plaster board 8 Ohms 10 W	1814	1/6
---------	---	------	-----

Sound diffusion

6772 99*	Bluetooth sound diffusion 2 module	4002	10/100
----------	------------------------------------	------	--------

Rotary dimmer universal

6773 04	Rotary led light dimmer 50 W 1 module	1814	1/10/120
---------	---------------------------------------	------	----------

* MRP - Maximum Retail Price Inclusive of all taxes including GST.

** To be Introduced Shortly

** Charging only with wireless compatible phone having induction receiver technology

Red Cat.Nos - new products

Lyncus™ electronic function

NEW!

Cat.Nos	Description	MRP* ₹ / Unit	Pack
---------	-------------	------------------	------

Touch switches

6773 09	6 A Touch switch 1 W 2 module	2758	1/50
6773 10	6 A Touch Switch 2 W 2 Module	3184	1/50
6773 13	16 A Touch switch 1 W 2 module	3184	1/50
6773 06	6 A Touch bell push 2 module	2758	1/50

Touch regulator & dimmer

6773 05	Touch fan regulator 100 W 2 module	3184	1/50
6773 15	300 W Universal led touch light scroll dimming 2 module	3184	1/50

Reading light

6773 16	Reading light led	1556	1/12
---------	-------------------	------	------

Accessories

6772 75	Cable outlet 8 mm 1 module	120	20/200
6772 76	Blanking plate 1 module	30	20/200
6772 77	Blanking plate 2 module	44	10/100

Lyncus™ mechanisms chic grey

Switches 6A 230V AC

6774 00	6 A Switch 1 W 1 module	86	20/200
6774 01	6 A Switch 2 W 1 module	152	20/200
6774 02	6 A Switch 1 W 1 module with Indicator	152	20/200
6774 03	6 A Switch 1 W 1 module with "Light" marking	142	20/200
6774 04	6 A Switch 1 W 1 module with "Fan" marking	142	20/200

Switches 10A 230V AC

6774 05	10 A Switch 1 W 2 module	184	10/100
6774 06	10 A Switch 2 W 2 module	216	10/100
6774 07	10 A Intermediate switch 2 module	1224	10/100
6774 08	10 A Switch 1 W with Indicator 2 module	236	10/100

Switches 16A 230V AC

6774 09	16 A Switch 1 W 1 module	168	20/200
6774 10	16 A Switch 2 W 1 module	212	20/200
6774 11	16 A Switch 1 W with indicator 1 module	222	20/200

Switches 20A 230V AC

6774 12	20 A Switch 1 W 1 module	254	20/200
6774 13	20 A DP Switch 1 W 2 module	370	10/100
6774 14	20 A DP Switch 1 W with indicator 2 module	376	10/100
6774 15	20 A Switch 2 W 2 module	422	10/100

Switches 25A 230V AC

6774 16	25A SP 1 W Switch with indicator 1 module	264	20/200
---------	---	-----	--------

Switches 32A 230V AC

6774 17	32A DP Switch with indicator 2 module	506	10/100
---------	---------------------------------------	-----	--------

Bold Cat.Nos are products normally available with Legrand (India) Stockists. Cat.Nos that are not bold - delivery within 4 - 8 weeks from the date of order. Bold packing quantity is our mandatory packing. Orders to be placed by Legrand (India) Stockist in multiples of the same.

Lyncus™ mechanisms chic grey

NEW!

Cat.Nos	Description	MRP* ₹ / Unit	Pack
---------	-------------	------------------	------

Push button 6A 230V AC

6774 18	6 A Push button SP 1 module	124	20/200
6774 19	6 A Push button SP with indicator 1 module	174	20/200
6774 20	6 A Bell push 1 module	156	20/200
6774 21	6 A Bell push with indicator module	188	20/200
6774 22	6 A Bell push 2 module	210	10/100
6774 23	6 A Bell Push with indicator 2 module	316	10/100

Sockets 240V AC

6774 25	6/16 A 2 Pin Euro US socket 1 module	268	20/200
6774 27	Multistandard socket 6/10/13 A 2/3 Pin for 250 VAC 15 A for 127 V type 2 Pin 2 module	282	10/100
6774 28	6 A 5 Pin Universal socket 2 module	216	20/200
6774 29	6/16 A Socket 3 module	330	5/50
6774 30	6/16 A Socket 2 module	280	10/100
6774 31	6/16 A Euro socket 2 module	286	10/100
6774 32	25 A Socket 2 module	286	10/100

Dimmers and fan regulators

6774 36	Rotary light dimmer 400 W 1 module	512	5/50
6774 37	Rotary light dimmer 500 W 2 module	656	10/100
6774 39	Fan regulator 100 W 1 module	470	5/50
6774 40	Fan regulator 100 W 360 degree 2 module	580	10/100
6774 41	Fan regulator 120 W 360 degree 2 module	660	10/100
6774 42	Fan step regulator 70 W 2 module	636	10/100

Skirting light

6774 48	LED skirting light 3 module	426	5/25
---------	-----------------------------	-----	------

Bell call indicator

6774 49	Bell call indicator 240 V 1 module	842	20/200
---------	------------------------------------	-----	--------

Buzzer

6774 50	Buzzer 230 V 1 module	568	20/200
---------	-----------------------	-----	--------

Remote unit

6774 52	Remote control unit for light & fan 4 module	3184	5/20
6773 03	Remote control hand unit	518	5/30

Hospitality function

Hotel keycard switch

6774 53	16A Key card switch 2 module credit card size key fob	2742	1/10
---------	---	------	------

Hotel "DND and MMR" functions

6774 56	DND & MMR indicator with bell push 1+1 module	300	10/100
6774 57	Internal control unit for DND & MMR 1+1 module	246	10/100

Lyncus™ hospitality function

NEW!

Cat.Nos	Description	MRP* ₹ / Unit	Pack
---------	-------------	------------------	------

Shaver socket

6774 58	Shaver socket 120/240 V MonoBlock with plate 2 module	2086	1/16
---------	---	------	------

Sockets and connectors

TV sockets

6774 60	TV Coaxial socket 1 module	156	20/200
---------	----------------------------	-----	--------

Data & voice

6774 62	Telephone socket RJ11 1 module	148	20/200
6774 63	Telephone socket double RJ11 1 module	250	20/200
6774 64	RJ 45 UTP cat 5 toolless with shutter 1 M grey	402	20/200
6774 65	RJ 45 UTP cat 6 toolless with shutter 1 M grey	564	20/200

Audio video sockets

6774 67	Preterminated audio video connector 1 module	1430	1/10
6774 68	Preterminated HDMI socket 1 module	1752	1/10
6774 69	Preterminated projector connector 1 module	1752	1/10

Sound (Volume controller)

6774 70	Volume controller 2 module	952	10/100
---------	----------------------------	-----	--------

Electronic function

USB chargers (IS13252 (Part 1) / IEC 609501)

6774 88	USB charger 1000 mA 1 module type A	686	5/50
6774 89	Double USB charger 3000 mA 2 module type A & type C	2092	10/100
6774 90	USB charger 1500 mA 1 module type C	1008	5/50

Combi (Socket+USB)

6774 92	Combi twin USB 2400 mA multistandard socket type A	2414	5/50
6774 94	Combi twin USB 2400 mA multistandard socket type A & type C	2658	5/50

Sound receiver

6774 99*	Bluetooth sound diffusion 2 module	4600	10/100
----------	------------------------------------	------	--------

Rotary dimmer universal

6774 24	Rotary led dimmer 50 W 1 module	2086	1/120
---------	---------------------------------	------	-------

Accessories

6774 75	Cable outlet 8 mm 1 module	140	20/200
6774 76	Blanking plate 1 module	34	20/200

Plate frame white

6775 01	Classic white plate + Frame 1 M	84	20/200
6775 02	Classic white plate + Frame 2 M	84	20/200
6775 03	Classic white plate + Frame 3 M	110	10/100

* MRP - Maximum Retail Price Inclusive of all taxes including GST.

To be Introduced Shortly

Red Cat.Nos - new products

Bold Cat.Nos are products normally available with Legrand (India) Stockists. Cat.Nos that are not bold - delivery within 4 - 8 weeks from the date of order. Bold packing quantity is our mandatory packing. Orders to be placed by Legrand (India) Stockist in multiples of the same.

Lyncus™

plate frame

NEW!

Cat.Nos	Description	MRP* ₹ / Unit	Pack
---------	-------------	------------------	------

Plate frame white

6775 04	Classic white plate + Frame 4 M	120	10/100
6775 06	Classic white plate + Frame 6 M	152	5/50
6775 08	Classic white plate + Frame 8 M (H)	196	5/50
6775 09	Classic white plate + Frame 2 x 4 M	202	5/25
6775 12	Classic white plate + Frame 12 M	282	10
6775 16	Classic white plate + Frame 16 M	330	10
6775 18	Classic white plate + Frame 18 M	442	10

Plate frame chic grey

6775 21	Chic grey plate+Frame 1 M	106	20/200
6775 22	Chic grey plate+Frame 2 M	106	20/200
6775 23	Chic grey plate+Frame 3 M	146	10/100
6775 24	Chic grey plate+Frame 4 M	154	10/100
6775 26	Chic grey plate+Frame 6 M	196	5/50
6775 28	Chic grey plate + Frame 8 M (H)	260	5/50
6775 29	Chic grey plate + Frame 2x4 M	260	5/25
6775 32	Chic grey plate + Frame 12 M	366	10
6775 36	Chic grey plate + Frame 16 M	422	10
6775 38	Chic grey plate + Frame 18 M	580	10

Plate frame brushed

6775 41	Brushed silver plate + Frame 1 M	112	20/200
6775 42	Brushed silver plate + Frame 2 M	112	20/200
6775 43	Brushed silver plate + Frame 3 M	154	10/100
6775 44	Brushed silver plate + Frame 4 M	162	10/100
6775 46	Brushed silver plate + Frame 6 M	208	5/50
6775 48	Brushed silver plate + Frame 8 M (H)	272	5/50
6775 49	Brushed silver plate + Frame 2x4 M	272	5/25
6775 52	Brushed silver plate + Frame 12 M	386	10
6775 56	Brushed silver plate + Frame 16 M	446	10
6775 58	Brushed silver plate + Frame 18 M	608	10

Plate frame alu sun set

6775 61	Alu sun set plate + Frame 1 M	110	20/200
6775 62	Alu sun set plate + Frame 2 M	110	20/200
6775 63	Alu sun set plate + Frame 3 M	146	10/100
6775 64	Alu sun set plate + Frame 4 M	160	10/100
6775 66	Alu sun set plate + Frame 6 M	202	5/50
6775 68	Alu sun set plate + Frame 8 M	260	5/50
6775 69	Alu sun set plate + Frame 2x4 M	264	5/25
6775 72	Alu sun set plate + Frame 12 M	378	10
6775 76	Alu sun set plate + Frame 16 M	434	10
6775 78	Alu sun set plate + Frame 18 M	594	10

Plate frame champagne

6775 81	Champagne plate + Frame 1 M	110	20/200
---------	-----------------------------	-----	--------

Lyncus™

Cat.Nos	Description	MRP* ₹ / Unit	Pack
---------	-------------	------------------	------

Plate frame champagne

6775 82	Champagne plate + Frame 2 M	110	20/200
6775 83	Champagne plate + Frame 3 M	146	10/100
6775 84	Champagne plate + Frame 4 M	160	10/100
6775 86	Champagne plate + Frame 6 M	202	5/50
6775 88	Champagne plate + Frame 8 M (H)	260	5/50
6775 89	Champagne plate + Frame 2x4 M	264	5/25
6775 92	Champagne plate + Frame 12 M	378	10
6775 96	Champagne plate + Frame 16 M	434	10
6775 98	Champagne plate + Frame 18 M	594	10

Plate frame matt silver

6776 01	Matt silver plate + Frame 1 M	110	20/200
6776 02	Matt silver plate + Frame 2 M	110	20/200
6776 03	Matt silver plate + Frame 3 M	146	10/100
6776 04	Matt silver plate + Frame 4 M	160	10/100
6776 06	Matt silver plate + Frame 6 M	202	5/50
6776 08	Matt silver plate + Frame 8 M (H)	260	5/50
6776 09	Matt silver plate + Frame 2x4 M	264	5/25
6776 12	Matt silver plate + Frame 12 M	378	10
6776 16	Matt silver plate + Frame 16 M	434	10
6776 18	Matt silver plate + Frame 18 M	594	10

Mounting boxes

Metal flush boxes

6890 07	Flush box - 1/2 module	98	40
6890 08	Flush box - 3 module	98	40
6890 09	Flush box - 4 module	132	40
6890 10	Flush box - 6 module	206	40
6890 42	Flush box - 8 module	242	40
6890 31	Flush box - 8 module (2 row x 4)	240	20
6890 11	Flush box - 12/16 (2 row x 6) module	364	10
6890 12	Flush box - 18 module	458	10

Plastic surface boxes

6733 02	Surface box 1/2 module	66	10/50
6733 03	Surface box 3 module	80	5/35
6733 04	Surface box 4 module	92	5/25
6733 06	Surface box 6 module	118	1/10
6733 08	Surface box 8 module	174	1/5
6733 05	Surface box 8 (2 row x 4) module	168	1/5

Metal surface boxes

6890 21	Surface box 12/16 (2 row x 6) module	418	1/6
6890 22	Surface box 18 module	440	1/4

* MRP - Maximum Retail Price Inclusive of all taxes including GST.

Red Cat.Nos - new products

To be Introduced Shortly

Bold Cat.Nos are products normally available with Legrand (India) Stockists. Cat.Nos that are not bold - delivery within 4 - 8 weeks from the date of order. Bold packing quantity is our mandatory packing. Orders to be placed by Legrand (India) Stockist in multiples of the same.

Britzy™ switches

Cat.Nos	Description	MRP* ₹ / Unit	Pack
---------	-------------	------------------	------

Switches

- All switches are ISI marked as per latest IS 3854:1997
- Finger-proof terminal for protection against accidental contact
- Laser marking for easy identification



6734 01



6734 12



6734 25



6734 04



6734 52



6734 53



6734 54

6734 01	6 A Switch SP 1 way 1 module	54	20/200
6734 02	6 A Switch SP 2 way 1 module	86	20/200
6734 03	6 A Switch SP 1 way with indicator 1 module	84	20/200
6734 11	16 A Switch SP 1 way 1 module	118	20/200
6734 12	16 A Switch SP 2 way 1 module	140	20/200
6734 13	16 A Switch SP 1 way with indicator 1 module	128	20/200
6734 24	25 A Switch SP 1 way with indicator 1 module	162	20/200
6734 25	20 A DP switch with indicator 2 modules	180	10/100
6734 26	32 A DP switch with indicator 2 modules	244	10/100

Push buttons

6734 04	6 A Bell push with indicator 1 module	98	20/200
6734 06	6 A Bell push with indicator 2 module	146	10/100

Sockets

- Confirming to IS 1293:2005
- Shuttered socket for child safety
- Shutter open only with phase and neutral insertion simultaneously

6734 52	6 A 3 pin universal socket 2 modules	100	10/100
6734 53	Euro US socket 1 module	84	20/200
6734 55	6/16 A socket 3 Pin 2 modules	160	10/100
6734 56	25 A socket 3 Pin 2 modules	180	10/100
6734 54	Multistandard socket 2 modules	142	10/100

* MRP - Maximum Retail Price Inclusive of all taxes including GST.

Britzy™ switches

Cat.Nos	Description	MRP* ₹ / Unit	Pack
---------	-------------	------------------	------

Data & voice

6734 41	RJ11 telephone socket 1 module	84	20/200
6734 44	Double RJ11 telephone socket 1 module	120	20/200
6734 45	RJ45 Cat 6 computer socket 1 module	236	20/200



6734 41



6734 44



6734 45

Television socket

6734 46	TV socket 1 module	78	20/200
----------------	------------------------------	----	--------

Buzzer

6734 40	Buzzer 230 V 1 module	252	20/200
---------	---------------------------------	-----	--------



6734 40

Dimmer & regulator

6734 31	Fan regulator 100 W 1 module	344	5/50
6734 30	Fan regulator 100 W 2 modules	436	10/100
6734 33	Light dimmer 400 W 1 module	352	5/50



6734 31

Bell indicator

6734 07	Bell call indicator 1 module	482	20/200
---------	--	-----	--------



6734 07

Motor starter

6734 66	25 A Motor starter 2 modules	400	10/100
---------	--	-----	--------



6734 66

Modular MCB (IS : 60898-1:2002)

6734 64	Modular SP MCB 16A	282	1/10/100
6734 61	Modular SP MCB 20A	282	1/10/100

Skirting light

6734 77	Skirting light 2 modules	334	5/50
---------	------------------------------------	-----	------



6734 77

Indicator

6734 75	Flat indicator red 1 module	90	20/200
----------------	---------------------------------------	----	--------



6734 75

Key card switch

6734 80	16 A Key card switch 2 modules	1818	1/10
6734 83	Keyfob credit card size for 6734 80	138	1/10



6734 80

Bold Cat.Nos are products normally available with Legrand (India) Stockists. Cat.Nos that are not bold - delivery within 4 - 8 weeks from the date of order. Bold packing quantity is our mandatory packing. Orders to be placed by Legrand (India) Stockist in multiples of the same.

Britzy™ switches

Cat.Nos	Description	MRP* ₹ / Unit	Pack
---------	-------------	------------------	------

Do Not Disturb indicator & internal control unit

6734 81	DND internal unit 2 modules	160	10/100
6734 82	DND external unit 2 modules	190	10/100

Accessories

6734 71	Cable outlet 1 module	68	20/200
6734 90	Blanking plate 1 module	26	20/200
6734 72	Blanking plate 2 modules	34	10/100

White plates with frame

Sleek and curvy plates with elegant looks comes with sturdy support frame for solid strength

6734 91	Plate & frame 86 x 86 1 module	58	20/200
6734 92	Plate & frame 86 x 86 2 modules	58	20/200
6734 93	Plate & frame 121 x 86 3 modules	78	10/100
6734 94	Plate & frame 146 x 86 4 modules	84	10/100
6734 96	Plate & frame 224 x 86 6 modules	110	5/50
6734 98	Plate & frame 245 x 86 8 modules	142	5/50
6734 95	Plate & frame 146 x 172 4 x 2 modules	142	5/25
6734 97	Plate & frame 224 x 172 12 modules	204	10
6734 99	Plate & frame 245 x 172 16 modules	224	10
6735 00	Plate & frame 224 x 240 18 modules	274	10

Flush mounting boxes - Metal

- Boxes are with top, bottom, side and back wall knockout for conduit entry from any direction
- Possible to break open knockout without any special tool

6890 60	Metal flush box 75.7 x 75.7 x 50.8 1 & 2 modules	54	40
6890 61	Metal flush box 98.9 x 75.7 x 50.8 3 modules	68	40
6890 62	Metal flush box 136 x 75.7 x 50.8 4 modules	84	40
6890 63	Metal flush box 213.4 x 75.7 x 50.8 6 modules	128	40
6890 64	Metal flush box 136.6 x 136.8 x 61 8 (2 rows x 4) modules	166	20
6890 65	Metal flush box 231.2 x 75.7 x 50.8 8 modules	166	40

* MRP - Maximum Retail Price Inclusive of all taxes including GST.

Britzy™ switches

Cat.Nos	Description	MRP* ₹ / Unit	Pack
---------	-------------	------------------	------

Flush mounting boxes - Metal

- Boxes are with top, bottom, side and back wall knockout for conduit entry from any direction
- Possible to break open knockout without any special tool

6890 66	Metal flush box 215 x 145.3 x 61.2 12 (2 rows x 6) modules	230	10
6890 67	Metal flush box 232.8 x 147.4 x 61.2 16 (2 rows x 8) modules	258	10
6890 68	Metal flush box 215 x 213.3 x 61.2 18 modules	296	10

Surface mounting boxes - Plastic

6890 70	Plastic surface box 86 x 86 x 45 1 & 2 modules	48	10/50
6890 71	Plastic surface box 121 x 86 x 45 3 modules	62	5/35
6890 72	Plastic surface box 146 x 86 x 45 4 modules	76	5/25
6890 73	Plastic surface box 224 x 86 x 45 6 modules	114	1/10
6890 74	Plastic surface box 146 x 172 x 45 8 (2 rows x 4) modules	160	2/10
6890 75	Plastic surface box 245.2 x 86 x 45 8 modules	160	1/10
6890 76	Plastic surface box 224 x 172 x 45 12 (2 rows x 6) modules	194	1/10
6890 77	Plastic surface box 245.2 x 172 x 45 16 (2 rows x 8) modules	226	1/10

Surface mounting boxes - Metal

6890 78	Metal surface box 18 modules	240	1/10
---------	--	-----	------

Britzy™ SWITCHES

Guarantee

- The Company, at its discretion, will replace products if they have any manufacturing defect within 10 years for switches (without LED lamp) and power sockets. For all other Britzy™ wiring accessories the guarantee will be 2 years.
- The above guarantee is applicable when the devices are used in Legrand metal flush boxes. Otherwise the guarantee period will be reduced by 50%.
- The guarantee is only applicable when the products are installed as per the Company's instructions and not tampered in any manner.
- The guarantee states the Company's entire liability. It does not extend to cover consequential loss or damage or installation costs arising from defective products.

Bold Cat.Nos are products normally available with Legrand (India) Stockists. Cat.Nos that are not bold - delivery within 4 - 8 weeks from the date of order. Bold packing quantity is our mandatory packing. Orders to be placed by Legrand (India) Stockist in multiples of the same.

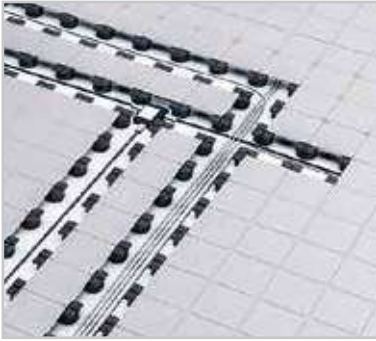

Soluflex cable floor system



Raceways : PVC & Metal (GI)



Floor boxes



Pop-up boxes - for furniture



Power & data desk grommets



DLP trunking system:
Snap-on, Mini & PVC,
Aluminium



Cablofil wire mesh cable trays



Cable worm



Flush mounting power & data
module

Power and data distribution & connection solutions



Raised access floor systems



Screed floor system

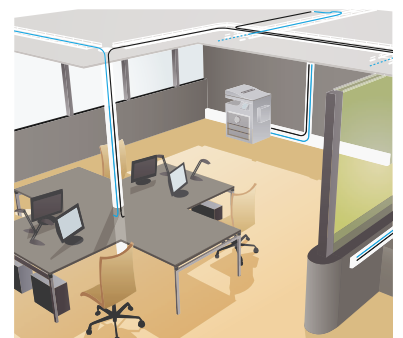

Wall and ceiling systems



Pop-up boxes - for floor



Snap-On columns

Legrand's solution for distributing power and data to workstations

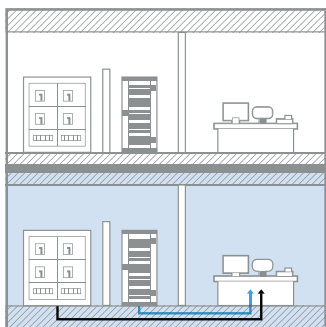

Work station solution supplied through the floor

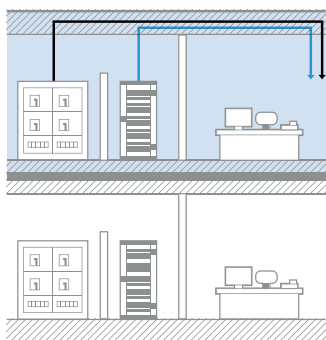

Work station solution supplied through the false ceiling & the wall

Workstation Solutions

Power and data distribution for the office environment

In order to guarantee convenience and performance for users in office buildings, workstations & different areas must be fitted with solutions that can be fully adjusted to different building infrastructures and still meet the user's connectivity and mobility needs.

These ranges of products are solutions for supplying and fitting out workstations in any kind of building infrastructure: Raised Floor, Flush Floor, Screed Floor & False Ceiling & Wall.

Raceways and junction boxes for screed floors

Cat.Nos	Description	MRP* ₹ / Unit	Pack
<p>Confirms to EN 50 085 - 2 - 2 Raceways are made from PVC and Galvanised sheet. Compatible with Cat.6 structured cabling system.</p>			
Raceways - PVC			
Raceways - PVC - height 38 mm; Standard length 2 meters⁽¹⁾; Price per meter			
0896 67	50 mm x 38 mm - 1 compartment	894	12
0896 68	100 mm x 38 mm - 2 compartments	1672	16
0896 69	150 mm x 38 mm - 3 compartments	2512	10
Raceways - Metal / GI			
Raceways - Metal/GI - height 25 mm; length 2.44 m. Price per unit (One unit is of 2.44 meters)			
6895 10	50 mm x 25 mm - 1 compartment	1558	3/54 ⁽¹⁾
6895 11	75 mm x 25 mm - 1 compartment	2006	3/21 ⁽¹⁾
6895 12	100 mm x 25 mm - 1 compartment	2436	3/54 ⁽¹⁾
6895 13	150 mm x 25 mm - 1 compartment	3376	3/18 ⁽¹⁾
6895 14	225 mm x 25 mm - 3 compartments	5290	3/12 ⁽¹⁾
6895 15	300 mm x 25 mm - 3 compartments	6552	3/18 ⁽¹⁾
Raceways - Metal/GI - height 38 mm; length 2.44 m Price per unit (One unit is of 2.44 meters)			
6895 00	50 mm x 38 mm - 1 compartment	1808	3/54 ⁽¹⁾
6895 01	75 mm x 38 mm - 1 compartment	2390	3/21 ⁽¹⁾
6895 02	100 mm x 38 mm - 1 compartment	2892	3/54 ⁽¹⁾
6895 03	150 mm x 38 mm - 1 compartment	3878	3/36 ⁽¹⁾
6895 04	225 mm x 38 mm - 3 compartments	5870	3/12 ⁽¹⁾
6895 05	300 mm x 38 mm - 3 compartments	7194	3/18 ⁽¹⁾
Raceways accessories			
Fixing bracket (GI) For fixing raceways (PVC & Metal) on the floor			
6897 09	50 mm x 25 mm (metal)	26	9
6897 10	75 mm x 25 mm (PVC and metal)	42	9
6897 12	100 mm x 25 mm (metal)	48	9
6897 15	150 mm x 25 mm (metal)	62	9
6897 20	225 mm x 25 mm (metal)	88	9
6897 30	300 mm x 25 mm (metal)	116	9
Fixing bracket			
6897 27	50 mm x 38 mm (PVC and metal)	28	9
6897 28	75 mm x 38 mm (metal)	46	9
6897 37	100 mm x 38 mm (PVC and metal)	56	9
6897 38	150 mm x 38 mm (PVC and metal)	70	9
6897 25	225 mm x 38 mm (metal)	108	9
6897 35	300 mm x 38 mm (metal)	136	9
Riser			
6897 23	Vertical - for 225 mm width raceways	1880	1
6897 33	Vertical - for 300 mm width raceways	2166	1

* MRP - Maximum Retail Price Inclusive of all taxes including GST.
(1) Unit of measure in Nos
*To be ordered in multiples of 2 meters

Raceways and junction boxes for screed floors

Cat.Nos	Description	MRP* ₹ / Unit	Pack
Coupler for joining raceways			
6897 77	Coupling 38	114	6
6897 79	Coupling 25	86	6
Junction box			
For direct access to cables at the intersection of raceways Supplied completely with base and cover plate (Lid)			
Height adjustable junction box 65 - 90 mm			
6896 10	150 x 150 x 65 - 90 mm	2054	1
6896 11	225 x 225 x 65 - 90 mm	2546	1
6896 12	300 x 300 x 65 - 90 mm	3356	1
6896 13	400 x 400 x 65 - 90 mm	5078	1
Height adjustable junction box 65 - 90 mm with fly over			
For direct access to cables at the intersection of floor raceways while maintaining perfect separation and 900 cross overs between data and power cables			
6896 14	225 x 225 x 65 - 90 mm with flyover	2814	1
6896 15	300 x 300 x 65 - 90 mm with flyover	3748	1
6896 16	400 x 400 x 65 - 90 mm with flyover	5618	1
Optional site cover for junction box			
6896 18	150 x 150 x 65 - 90 mm with metal cover	234	10
6896 19	225 x 225 x 65 - 90 mm with metal cover	334	10
6896 20	300 x 300 x 65 - 90 mm with metal cover	506	10
6896 21	400 x 400 x 65 - 90 mm with metal cover	768	10
Height adjustable junction box 50 - 70 mm			
6896 22	150 x 150 x 50-70 mm	1892	1
6896 23	225 x 225 x 50-70 mm	2326	1
6896 24	300 x 300 x 50-70 mm	3092	1
6896 25	400 x 400 x 50-70 mm	4636	1
Floor boxes for carpet for raised floor, screed floor			
Floor boxes for raised floor			
6896 38	Full backbox for raised floor - 3 compartments (264x264 mm) height 86 mm	3232	1
6896 31	Lid & trim Grey cover RAL 7031 for 3 compartment floor box with flexible cable exits Size 265 mm x 265 mm	2438	5
Support plates for floor boxes 77 mm width plate			
6896 62	Blank plates for floor box	272	12
6896 17	Flat support plate 8 module for integration of Myrius/Arteor mechanisms	272	1
6896 78	Waved support plates. For 4 modules (2 x 2 modules)	826	4

Bold Cat.Nos are products normally available with Legrand (India) Stockists. Cat.Nos that are not bold - delivery within 4 - 8 weeks from the date of order. Bold packing quantity is our mandatory packing. Orders to be placed by Legrand (India) Stockist in multiples of the same.

Floor boxes for carpet for raised floor, screed floor

Cat.Nos	Description	MRP* ₹ / Unit	Pack
---------	-------------	------------------	------

Floor boxes for screed floor (3 Compartment)

6896 34#	Full backbox for screed floor 3 compartments (for ducting upto 225 mm). Height adjustable to screed height 65 to 90 mm	5004	1
6896 31#	Lid & trim Grey cover RAL 7031 for 3 compartment floor box with flexible cable exits. Size 265 mm x 265 mm	2438	5



6896 34 +
6896 31

Support plates for floor boxes 77 mm width plate

6896 62	Blank plates for floor box	272	12
6896 17	Flat support plate 8 module for integration of Myrius/Arteor mechanisms	272	1
6896 78	Waved support plates for 4 modules (2x2 modules)	826	4

Floor boxes for screed floor (4 Compartment)

6896 45	Full backbox for screed floor - 4 compartments (for ducting upto 300 mm) Height adjustable to screed height 65 to 90 mm. To be used with 6896 45	5568	1
6896 41	Lid & trim Grey cover RAL 1019 for 4 compartment floor box with flexible cable exits. To be used with 6896 41	2676	5

Support plates for floor boxes

77 mm width plate

6896 62	Blank plates for floor box	272	12
6896 17	Flat support plate 8 module for integration of Myrius/Arteor	272	1
6896 78	Waved support plates For 4 Modules (2x2 Modules) mechanisms	826	4

Stainless steel insert for Lid

For a metal finish on lid
To be used instead of fitting carpet onto the Lid

6896 92	For 3 compartment floor boxes dimension : 245.5x210 mm	3012	1
---------	--	------	---

Floor boxes for tile / marble

for screed floor

0896 04	Backbox for screed floor; Screed thickness 65 to 90 mm	4318	1
6896 52	Lid & trim for tiles / marble 15 to 22 mm thickness Stainless steel material AISI 304. 2 cable outlet	20982	1
6896 55	Lid & Trim for tile 8-15 mm thickness Material for head band & single cable outlet - galvanised steel + paint RAL 7031	5752	1

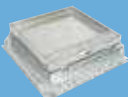

0896 04 +
6896 52

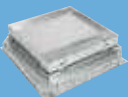

0896 04 +
6896 55

* MRP - Maximum Retail Price Inclusive of all taxes including GST.
6896 34 + 6896 31 with support plates and wiring devices

Floor boxes for tile / marble

Cat.Nos	Description	MRP* ₹ / Unit	Pack
---------	-------------	------------------	------

for screed floor

6896 56	Lid & Trim for tile 8-15 mm thickness Material for head band & single cable outlet - stainless steel 304	7012	1
---------	--	------	---

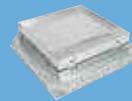

0896 04 +
6896 56

Support plates for floor boxes

77 mm width plate

6896 62	Blank plates for floor box	272	12
6896 17	Flat support plate 8 module for integration of Myrius/Arteor	272	1
6896 78	Waved support plates For 4 Modules (2x2 Modules) mechanisms	826	4

50mm reduced height floor boxes

0880 73	Back box for Concrete Floor (to be used with 0880 70)	6380	1
0880 70	Lid and Trim for Screed Floor between 50 and 70 mm. With Cover for carpet; grey RAL 7031 Can be equipped with SS finishing plate 0880 72 16 Module	6300	1
0880 72	Stainless steel finishing plate for 50 mm floor box	3926	1

Heavy duty in-screed floor box

for screed floors

Metal in-screed floor box

0896 34	Universal metal in-screed backbox	17528	1
---------	-----------------------------------	-------	---

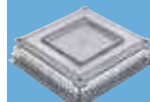

0896 34 +
0896 83 +
0896 85

Accessories for metal in-screed floor box

0896 83	Normal load support upto 8 KN load with deflection <6 mm	17528	1
0896 84	Heavy load support upto 20 KN load with deflection <3 mm	29634	1



0896 34 +
0896 83 +
0896 86 +
0896 87

Plates for metal in-screed floor boxes

77 mm width plate

0896 85	IP 66 plain cover (cover closed) access trap for junction. No cable exit	30476	1
---------	--	-------	---

Heavy duty in screed floor box with cable exit

0896 34	Metal in-screed floor box	17528	1
---------	---------------------------	-------	---

Accessories for metal in screed floor box

0896 83	Normal load support upto 8 KN load with deflection <6 mm	17528	1
0896 84	Heavy load support up to 20 KN load with deflection <3 mm	29634	1

Bold Cat.Nos are products normally available with Legrand (India) Stockists. Cat.Nos that are not bold - delivery within 4 - 8 weeks from the date of order. Bold packing quantity is our mandatory packing. Orders to be placed by Legrand (India) Stockist in multiples of the same.

Heavy duty in-screed floor box for screed floors

Cat.Nos	Description	MRP* ₹ / Unit	Pack
---------	-------------	------------------	------

Plates for metal in-screed floor boxes

0896 86	IP 66 plate (cover closed and plugs not connected) with central cable exit	61008	1
0896 87	IP 14 Cable exit accessory for IP66 cover plate Cat.No 0896 86 be used as a simple access to the floor void	32602	1

Over floor trunking

Conform to Std EN 50085-2-2; For creating a link between trunking, column, mini-column, floor units or protecting cables on passageways Supplied with cover

0300 92	Over floor trunking 50 x 12 mm; length 2 m, supplied with cover; 3 Compartments;	420	54 ⁽¹⁾
0300 11	Flat angle/floor 50 x 12	166	10
0300 12	Cover joint/floor 50 x 12	210	10
0300 93	Over floor trunking 75 x 18 mm; length 2 m, supplied with cover; 3 compartments;	576	36 ⁽¹⁾
0300 18	Flat angle/floor 75 x 18	318	10
0300 19	Cover joint/floor 50 x 12	220	10
0328 00	Over floor trunking 92 x 20 mm; Length 2 m, supplied with cover; 4 Compartments, equipped with 2 adhesive strips for better floor fixing	1056	20 ⁽¹⁾
0328 07	End cap for floor duct 92 x 20	184	10
0328 03	Cover joint for floor duct 92 x 20	250	10
0328 02	Flat angle for floor duct 92 x 20	458	5

Floor boxes 3 module for screed floor and raised floor

Floor service outlet boxes - 3 modules

0896 44	Floor service outlet box - 3 modules Grey RAL 7031 To be equipped with Arteor Mechanism	1334	1
0896 49	Flush mounting box for concrete for Cat.No 0896 44	890	1

IP 66 Floor box - 4 module

Conform to EN 60670-1 and EN 60670-23 standards (when lid is closed) / IP55 (with cable exit accessory Cat.No 0880 62)

0880 61	IP66/IK09 screwed stainl. steel floor box (with removable lid); can be equipped with cable exit accessory Cat.No 0880 62	14550	1
0880 64	IP66/IK09 hinged cover stainl. steel floor box	17506	1

Floor boxes 3 module for screed floor and raised floor

Cat.Nos	Description	MRP* ₹ / Unit	Pack
---------	-------------	------------------	------

IP 66 Floor box - 4 module

Conform to EN 60670-1 and EN 60670-23 standards (when lid is closed) / IP55 (with cable exit accessory Cat.No 0880 62)

0880 69	Auto adjustable back box for installing IP66 floor boxes in concrete floors; supplied with cover; accepts conduit dia 20 mm; min screed height 65 mm	2794	1
0880 62	IP55 cable exit accessory	16060	1

Floor access unit for raised floors

IP 20 - IK 08

0893 07	Access master box floor box that can be used as a simple access to the floor void	6228	1
---------	--	------	---

Pop-up type flush-mounting boxes for floor

Pop-up boxes to be equipped

Equipped with "push and slide" locking system to avoid accidental opening by feet
To be equipped with Arteor/Myrius socket outlets
For installation use the flush-mounting boxes for concrete floors or the kits for raised access floors

3 modules

0540 10	Matt aluminium finish	2130	1
0540 15	Brushed brass	3040	1
0540 20	Brushed Stainless steel finish	3074	1

4 modules

0540 11	Matt aluminium finish	2828	1
0540 16	Brushed brass	3600	1
0540 21	Brushed Stainless Steel finish	3896	1
0540 26	Matt black	3520	1
0540 31	Glossy white	3604	1

6 (2 x 3) modules

0540 12	Matt aluminium finish	4732	1
0540 17	Brushed brass	6528	1
0540 22	Brushed stainless steel finish	6768	1

8 (2 x 4) modules

0540 13	Matt aluminium finish	5856	1
0540 18	Brushed brass	7832	1
0540 23	Brushed stainless steel finish	8332	1
0540 28	Matt black	7546	1
0540 33	Glossy white	7590	1

Retractable accessory for Pop Up

0540 34	RJ45 Cat 6 UTP retractable Kit - 1 module	2918	1
0540 35	RJ45 Cat 6 FTP retractable Kit - 1 module	4082	1
0540 36	USB/ Micro-USB Retractable Kit - 1 module	2764	1

* MRP - Maximum Retail Price Inclusive of all taxes including GST.
(1) Price in Meters; No of meters in Pack, Standard length 2 meters to be ordered in multiple of 2 meters.

Bold Cat.Nos are products normally available with Legrand (India) Stockists. Cat.Nos that are not bold - delivery within 4 - 8 weeks from the date of order. Bold packing quantity is our mandatory packing. Orders to be placed by Legrand (India) Stockist in multiples of the same.

Pop-up type flush-mounting boxes for floor

Cat.Nos	Description	MRP* ₹ / Unit	Pack
---------	-------------	------------------	------

Installation kits for raised access floors

Include an empty receptacle and fixing brackets for raised access floor tiles Compatible with:

- Cat. 6 data cabling
- Audio/video cabling

0540 05	3 modules	962	1
0540 06	4 modules	1156	1
0540 07	6 (2 x 3) modules	1604	1
0540 08	8 (2 x 4) module	1978	1

For installation of pop-up floor boxes in concrete floors

Equipped with knockouts for ø 20 and ø 25 mm conduits

Metal flush-mounting boxes

0540 00	3 modules	262	1
0540 01	4 modules	346	1
0540 02	6 (2 x 3) modules	554	1
0540 03	8 (2 x 4) modules	692	1

Pop-up type flush-mounting boxes for furniture

Pop-up boxes to be equipped

Slim design for perfect integration into the furniture
To be equipped with Arteor socket outlets
Supplied alongwith installation kits for table top

4 modules

6540 14	Matt Aluminium	2800	1
6540 00	Matt steel finish	3742	1
6540 01	Glossy White	3462	1
6540 02	Matt Black	3314	1

8 (2 x 4) modules

6540 15	Matt Aluminium	5800	1
6540 03	Matt steel finish	8096	1
6540 04	Glossy White	7366	1
6540 05	Matt Black	7322	1

Power & data desk grommets for workstation & meeting room table application

Empty power & data desk grommets

To be equipped with Myrius or Arteor socket outlets, Easily retro fitted into a 60 to 80 mm diameter hole in current office desks and workspace table tops (by replacing the desk grommet)
Cover opens to 180° angle to prevent breaking

For one 2P+E socket

0540 70▲	White RAL 9003, to be equipped with 1 socket	1994	1
0540 71▲	Black RAL 9017, to be equipped with 1 socket	1850	1

For one 2P+E socket and USB phone charger

Supplied with one USB phone charger output

5 V = 750 mA, to be wired

0540 72▲	White RAL 9003 with USB, to be equipped with 1 socket	4758	1
0540 73▲	Black RAL 9017 with USB, to be equipped with 1 socket	5186	1

* MRP - Maximum Retail Price Inclusive of all taxes including GST.

▲ Finishing Plates to be ordered separately

Red Cat.Nos - new products

Power & data desk grommets for workstation & meeting room table application

Cat.Nos	Description	MRP* ₹ / Unit	Pack
---------	-------------	------------------	------

Pre-wired modules with retractable cords

For fitting on an empty power & data desktop modules (under the table top)

Automatic cable rewind when not connected, for an optimized use of the desk surface

Cat. 6 FTP

0540 65	Equipped with - 1.35 m RJ 45 Cat. 6 FTP retractable cord on the user side and - 1 x RJ 45 socket on the installation side Patch cord for connection to data network to be ordered separately	2910	1
---------	--	------	---

USB / micro USB

0540 67	Equipped with - 1.35 m retractable cord with micro USB connector, on the user side and - 0.5 m cable with USB connector on the installation side	2638	1
---------	--	------	---

Finishing plates for empty power & data desk grommets

For fitting on an empty power & data desk grommets

0540 60	White RAL 9003	288	10
0540 62	Black RAL 9017	318	10
0540 63	Stainless steel	1154	10

Cable worm

0535 98	2 compartments, Length: 0.75 m White colour very suitable solution for a safe and design protection of the cabling between desk and floor	4554	1
---------	---	------	---

Flush mounting power and data module

A ready to embed solution for all dry support with thickness between 2 and 40 mm. Conform to standard NFC 61-314 which ensures safety of the user Aesthetic product (no visible screw), thickness of 6mm only. Product available in 8 and 12 module, with the option of configuring power sockets, data, AV, protection etc. 3 Finishes; white/ black and aluminium

Flush mounting power and data module to be equipped

Aluminium extensions with cable guide (reversible)
To be equipped with Arteor sockets

8 module; length - 180 mm

0535 60	Flush 8 mod white finish	5204	1
0535 61	Flush 8 mod aluminium finish	6134	1
0535 62	Flush 8 mod black finish	5064	1

12 module; length - 270 mm

0535 63	Flush 12 mod white finish	5470	1
0535 64	Flush 12 mod aluminium finish	6592	1
0535 65	Flush 12 mod black finish	5520	1

Bold Cat.Nos are products normally available with Legrand (India) Stockists. Cat.Nos that are not bold - delivery within 4 - 8 weeks from the date of order. Bold packing quantity is our mandatory packing. Orders to be placed by Legrand (India) Stockist in multiples of the same.



Click to discover us

- 1** Legrand (India) - provides all information regarding the groups philosophy, products, organisation etc.
- 2** Products and solutions - complete information about our range of products for residential, commercial and industrial markets.
- 3** Downloads - download catalogues and brochures.

snap-on trunking routing sections and accessories

TRUNKING			TRUNKING		
Number of compartments	Cover width	Cross-section (mm)	Monobloc: body + cover ⁽¹⁾	Divider	Fishplate body joint
SNAP-ON TRUNKING - 45 mm cover					
	45	50 x 80	○ 0756 01	0756 09	0756 61
	45	50 x 105	0756 02	0756 09	0756 62
	45 45	50 x 130	○ 0756 03	-	0756 61
	45 45	50 x 145	0756 04	-	0756 63
	45 45 45	50 x 180	0756 06	-	0756 61

1: Partition(s) integral to the body
2: Internal and external corner angles supplied with multi-compartment partition joint

mechanisms for snap-on trunking

Mounting functions

The Arteor sockets to be fitted with Soluclip accessory which has following features:

- Anti-slip
- Anti-pullout
- IP 4X
- Perfect finish



0756 90

AND ACCESSORIES			ANGLES			JUNCTIONS				ACCESSORIES
Stick-on body joint	Cover joint	End cap	Internal angles ⁽²⁾	External angles	Flat angles	Flat junctions with width 80 mm	Flat junctions with width 105 mm	Angled junctions 85/105/130 mm	Junction with floor duct 50 x 12/ 92 x 20	Extra cover
0756 66	0756 69	0756 11	0756 21	0756 31	0756 41	0756 71	-	0756 81 + 0756 21	0756 88	0756 08
0756 67	0756 69	0756 12	0756 22	0756 32	0756 42	0756 72	0756 76	0756 81 + 0756 22	0756 88	0756 08
0756 66	2 x 0756 69	0756 13	0756 23	0756 33	0756 43	0756 71	0756 75	0756 81 + 0756 23	0756 88	0756 08
① 0756 66 + ② 0756 67	2 x 0756 69	0756 14	0756 24	0756 34	0756 44	① 0756 71 + ② 0756 72	① 0756 75 + ② 0756 76	0756 81 + 0756 24	0756 88	0756 08
0756 66	3 x 0756 69	0756 16	0756 26	0756 36	0756 46	0756 71	0756 75	0756 81 + 0756 26	0756 88	0756 08

Installation principle for sockets for snap-on trunking

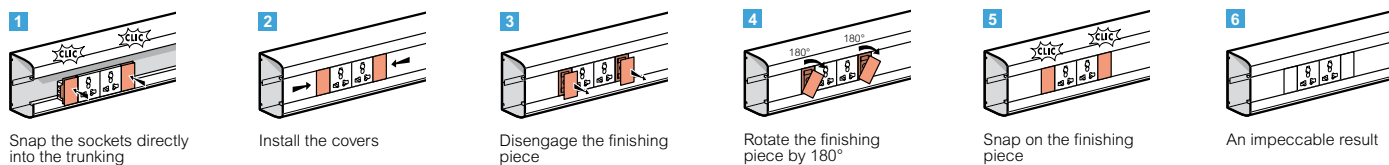

Installation principle for Arteor functions

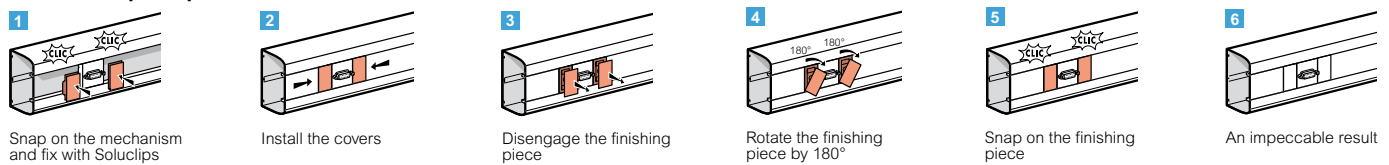

DLP PVC adaptable trunking systems for installations base, covers, partitions, finishing accessories and mounting wiring accessories

Selection chart for Installation of trunking, Accessories and Arteor™

Trunking			Covers		Clip on partition		Arteor™ frames				
Number of compartments	Cover(s) width	Section (mm)									
			Flexible	Partitions separation	Plastic	Aluminium	1 module	2 module	3 module	4 module	6 module
0104 12	1 1 x 65	80 x 50	0105 21	0105 82	-	-	-	0109 21	0109 31	0109 41	0109 61
0104 22	1 1 x 85	105 x 50	0105 22	0105 82	-	-	-	0109 22	0109 32	0109 42	0109 62
	2 2 x 40		0105 20	0105 82	0104 72	0111 06	0109 10	-	-	-	-
0104 32	1 1 x 130	150 x 50	0105 24	0105 82	-	-	-	-	-	-	-
	2 2 x 65		0105 21	0105 82	0104 72	0111 06	-	0109 21	0109 31	0109 41	0109 61
	2 1 x 40 + 1 x 85		0105 20 + 0105 22	0105 82	0104 72	0111 06	0109 10	0109 22	0109 32	0109 42	0109 62
	3 3 x 40		0105 20	0105 82	0104 72 x 2	0111 06 x 2	0109 10	-	-	-	-
0104 52	1 1 x 180	195 x 50	0105 26	0105 82	-	-	-	-	-	-	-
	2 2 x 85		0105 22	0105 82	0104 72	0111 06	-	0109 22	0109 32	0109 42	0109 62
	2 1 x 40 + 1 x 130		0105 20 + 0105 24	0105 82	0104 72	0111 06	0109 10	-	-	-	-
	3 1 x 85 + 2 x 40		0105 22 + 0105 20	0105 82	0104 72 x 2	0111 06 x 2	0109 10	0109 22	0109 32	0109 42	0109 62
	3 1 x 40 + 2 x 65		0105 20 + 0105 21	0105 82	0104 72 x 2	0111 06 x 2	0109 10	0109 21	0109 31	0109 41	0109 61
	4 4 x 40		0105 20	0105 82	0104 72 x 3	0111 06 x 3	0109 10	-	-	-	-

Selection chart for Installation trunking, Accessories and Arteor™

Section (mm)	Wall crossing	Capacity change	Partition junction	Cable tie base	Insulating unit for Arteor™ modules	Earth Link
80 x 50 / 105 x 50	0106 98	0106 87 + 0106 88 + 0106 89 (to be used for partition)	0106 89	0308 81	2 Module Combined to get 4/6 Module	0111 88
150 x 50 / 195 x 50	0106 99					

Selection chart for Installation of trunking, Additional accessories

Cover	Bases		Internal angles 80° - 100°			External angles 60° - 120°			Flat angles		Flat junction			
Joint for covers	Base joint	End caps	Angles	Partition junction	VDI access.	Angles	Partition junction	VDI access.	Angles	VDI access.	Angles	Partition junction	VDI access.	Clips
0108 01	0106 91	0107 22	0106 02	-	0107 80	0106 22	-	0107 81	0107 67	0107 82	0107 32	-	0107 83	0106 82
0108 02	0106 91	0107 02	0106 02	-	0107 80	0106 22	-	0107 81	0107 85	0107 82	0107 32	-	0107 83	0106 82
0108 00	0106 91	0107 02	0106 02	0106 11	-	0106 22	0106 32	-	-	-	0107 32	0107 42	-	0106 82
0108 04	0106 91	0107 06	0106 02	-	-	0106 22	-	-	0107 89	-	0107 32	-	-	0106 86
0108 01	0106 91	0107 06	0106 02	0106 11	0107 80	0106 22	0106 32	0107 81	0107 89	0107 82	0107 32	0107 42	0107 83	0106 82
0108 02	0106 91	0107 06	0106 02	0106 11	0107 80	0106 22	0106 32	0107 81	0107 89	0107 82	0107 32	0107 42	0107 83	0106 82
0108 00	0106 91	0107 06	0106 02	0106 11 x 2	-	0106 22	0106 32 x 2	-	0107 89	-	0107 32	0107 42	-	0106 82
0108 06	0106 91	0107 07	0106 02	-	-	0106 22	-	-	0107 92	-	0107 32	-	-	0106 86
0108 02	0106 91	0107 07	0106 02	0106 11	0107 80	0106 22	0106 32	0107 81	0107 92	0107 82	0107 32	0107 42	0107 83	0106 82
	0106 91	0107 07	0106 02	0106 11	0107 80	0106 22	0106 32	0107 81	0107 92	0107 82	0107 32	0107 42	0107 83	
	0106 91	0107 07	0106 02	0106 11 x 2	0107 80	0106 22	0106 32 x 2	0107 81	0107 92	0107 82	0107 32	0107 42	0107 83	0106 82
	0106 91	0107 07	0106 02	0106 11 x 2	0107 80	0106 22	0106 32 x 2	0107 81	0107 92	0107 82	0107 32	0107 42	0107 83	0106 82
0108 00	0106 91	0107 07	0106 02	0106 11 x 3	-	0106 22	0106 32 x 3	-	0107 92	-	0107 32	0107 42	-	0106 82

DLP mini trunking systems for cable distribution







■ Selection chart for DLP mini trunking

	Length	Finishing Accessories				Junction Elements
WHITE	2 m	End cap	Internal angle	External angle	Flat angle	Flat junction
32 x 12.5	0300 15	0312 03	0302 51	0302 51	0302 53	0302 54
32 x 16	0308 04	0312 07	0333 25	0333 25	0333 27	0333 30
32 x 20	0300 17	0312 09	0302 71	0302 71	0302 73	0302 74



DLP aluminium trunking system

selection chart of sections, covers and accessories
selection chart of support for wiring accessories

TRUNKING AND ACCESSORIES

Width (mm)	Nos. of compartments	Covers width	Cat. nos.	Rigid covers 				 Cover Joint	 Trunking Base Joint
				65 mm width	85 mm width	130 mm width	180 mm width		
105 x 50	1 	1 x 85	111 00	-	0111 11	-	-	0111 63	0111 66
150 x 50	2 	2 x 65	0111 02	2 x 0111 10	-	-	-	0111 62	0111 66
195 x 50	2 	2 x 85	0111 04	-	2 x 0111 11	-	-	0111 63	0111 66

SUPPORT FOR WIRING ACCESSORIES

60 mm fixing centers : Arteur™	Cover depths	
No of module	65 mm	85 mm
2 modules 	0112 02	0112 12
3 modules 	0112 03	0112 13
4 modules 	0112 04	0112 14
6 modules 	0112 06	0112 16

Insulation resistance : the entire DLP range, including accessories, have insulation resistance above 5 Megaohms

DLP TRUNKING SYSTEM ALUMINIUM

with aluminium adaptable
DLP trunking,
get better styling too !



SELECTION CHART OF ACCESSORIES (continued)

Dividers		End cap	Internal angles	External angles	Flat angles	Junction Flat junction*	Clips	Earth link
Clip-on partition	Separation partition							
-	0111 08	0111 58	0112 21	0112 32	0112 43	0112 51	0106 82	0111 88
0111 06	0111 08	0111 60	0112 27	0112 38	0112 45	0112 51	0106 82	0111 88
0111 06	0111 08	0111 61	0112 29	0112 40	0112 47	0112 51	0106 82	0111 88

(1) To be used with angle covers. (2) To be used with rigid covers

TABLE OF CAPACITIES

	Crosssection (mm ²) Max. Ø (mm ²)	105 x 50	150 x 50		195 x 50	
		cover 85	cover 65	cover 65	cover 85	cover 85
Trunking only	Cross-section	4330	3020	3020	5350	5350
	Max. Ø	28	43	43	55	55
With Arteor™ / support	Cross-section	2300	1470	1470	3320	3320
	Max. Ø	2 x 24	18	18	33	33

*To tap off 105 mm wide trunking with 85 mm cover



SAVE TIME

- Flexibility : multi-covers
- Removable separation
- Angles delivered pre-cut, ready to use
- Fast fixing device support
- Uniform colours for the entire installation
- Arteor™ wiring accessories go with aluminium adaptable DLP trunking

Snap-on trunking routing sections and accessories

Snap-on trunking routing sections and accessories

Cat.Nos	Description	MRP* ₹ / Unit	Pack
Snap-on trunking			
Monobloc: Body + Cover, can take any Arteor wiring accessory			
0756 01	Snap-on trunking 50 x 80 1 - compartment	902	20 ⁽¹⁾
0756 02	Snap-on trunking 50 x 105 1 - compartment	1146	12 ⁽¹⁾
0756 03	Snap-on trunking 50 x 130 2 - compartments	1578	12 ⁽¹⁾
0756 04	Snap-on trunking 50 x 145 2 - compartments	2034	8 ⁽¹⁾
0756 06	Snap-on trunking 50 x 180 3 - compartments	2242	8 ⁽¹⁾
Divider			
0756 09	Divider	194	26 ⁽¹⁾
Extra cover			
0756 08	Width 45 mm	348	20 ⁽¹⁾
Joints			
Fishplate Body joint			
0756 61	Set of 2 Body joints	314	10
0756 62	Set of 2 Body joints	416	10
0756 63	Set of 2 Body joints	364	10
Stick-on body joint			
0756 66	For top part of body	204	20
0756 67	For bottom part of body	246	20
Cover joint			
0756 69	Cover joint, width 45 mm	110	10
End caps			
0756 11	Left or right end cap	182	10
0756 12	Left or right end cap	182	10
0756 13	Left or right end cap	300	5
0756 14	Left or right end cap	310	5
0756 16	Left or right end cap	340	5
Height spacer			
0105 80	Colour charcoal grey for fitting 15 mm from the ground	456	24 ⁽¹⁾
Soluclip accessory			
Fishplate body joint			
0756 90	For installation with any Arteor function	156	10
Angles			
Internal angles			
0756 21	varies from 80° to 100°	416	10
0756 22	varies from 80° to 100°	580	10
0756 23	varies from 80° to 100°	976	5
0756 24	varies from 80° to 100°	1568	5
0756 26	varies from 80° to 100°	1386	5
External angles			
0756 31	varies from 85° to 120°	868	10
0756 32	varies from 85° to 120°	1332	10
0756 33	varies from 85° to 120°	1806	5
0756 34	varies from 85° to 120°	2126	5
0756 36	varies from 85° to 120°	2522	5
Flat angles			
0756 41	Flat angle at 90°	508	10
0756 42	Flat angle at 90°	668	10
0756 43	Flat angle at 90°	1332	5
0756 44	Flat angle at 90°	1246	5
0756 46	Flat angle at 90°	2494	5

Cat.Nos	Description	MRP* ₹ / Unit	Pack
Junctions			
Flat junctions with 80 mm width			
0756 71	Creates a junction	698	5
0756 72	Creates a junction	698	5
For 105 mm wide upward trunking			
0756 75	Creates a junction	684	5
0756 76	Creates a junction	746	5
Angled junction			
Must be used in conjunction with an internal angle			
0756 81	Creates a junction in an internal angle	1536	5
Junction with floor duct			
0756 88	Creates a junction with a floor duct size 50 x 12 mm or 92 x 20 mm	804	5
DLP PVC trunking system			
Mini-trunking system			
Mini-trunking - 32 x 12.5 mm			
0300 15	Without central partition	100	80 ⁽¹⁾
Finishing accessories			
0312 03	End cap right or left	52	20/400
0302 51	Changeable internal - external angle from 60° to 120°	74	10/100
0302 53	Changeable flat angle from 85° to 95°	82	10/100
0302 54	Flat junction	104	10/200
0336 03	White 32 x 10/12.5 Cover Gasket	102	20
Mini-trunking - 32 x 16 mm			
0308 04	Without central partition	130	60 ⁽¹⁾
Finishing accessories			
0312 07	End cap right or left	80	10
0333 25	Changeable internal - external angle from 60° to 120°	88	10
0333 27	Changeable flat angle from 85° to 95°	86	10
0333 30	Flat junction	122	10
0336 04	White 32 x 16/20 Cover Gasket	102	20
Mini-trunking - 32 x 20 mm			
0300 17	Without partition	138	50 ⁽¹⁾
Finishing accessories			
0312 09	End cap right or left	110	10
0302 71	Changeable internal - external angle from 60° to 120°	104	10
0302 73	Changeable flat angle from 85° to 95°	88	10
0302 74	Flat junction	102	10
0336 04	White 32 x 16/20 Cover Gasket	102	20

* MRP - Maximum Retail Price Inclusive of all taxes including GST.
(1) Price in Meters; No of meters in Pack, Standard length 2 meters to be ordered in multiples of 2 meters

Bold Cat.Nos are products normally available with Legrand (India) Stockists. Cat.Nos that are not bold - delivery within 4 - 8 weeks from the date of order. Bold packing quantity is our mandatory packing. Orders to be placed by Legrand (India) Stockist in multiples of the same.

DLP PVC trunking system and accessories - trunking and fittings

Cat.Nos	Description	MRP* ₹ / Unit	Pack
---------	-------------	------------------	------

Trunking

Bodies

Supplied without cover

0104 12	80 x 50 mm	570	20 ⁽¹⁾
0104 22	105 x 50 mm	708	20 ⁽¹⁾
0104 32	150 x 50 mm	1198	10 ⁽¹⁾
0104 52	195 x 50 mm	1586	8 ⁽¹⁾

Flexible cover

Fits onto the whole branch including in internal or external angles

0105 20	Full covers width 40 mm	280	20 ⁽¹⁾
0105 21	Full cover width 65 mm	274	24 ⁽¹⁾
0105 22	Full cover width 85 mm	316	20 ⁽¹⁾
0105 24	Full cover width 130 mm	668	8
0105 26	Full cover width 180 mm	850	8 ⁽¹⁾

Partitions

0105 82	Separation partition	186	24 ⁽¹⁾
0104 72	Clip-on partition - Plastic	274	48 ⁽¹⁾
0111 06	Clip-on partition - Aluminium	1076	12 ⁽¹⁾

Joints

0106 91	Body / Base joint - For aligning bases during installation	64	20/200
0108 00	Cover joint for 40 mm width	130	10/100
0108 01	Cover joint for 65 mm width	110	10/100
0108 02	Cover joint for 85 mm width	168	10/100
0108 04	Cover joint for 130 mm width	282	10/100
0108 06	Cover joint for 180 mm width	260	10/100

Angles and end caps

Internal and external angles

Include the 2 components for the top and bottom of the trunking on which the flexible cover is fitted

0106 02	Internal angle, adjustable from 80° to 100°	402	10/40
0106 22	External angle, adjustable from 60° to 120°	392	10/50

Flat angle

0107 67	90° flat angle	554	10
0107 85	90° flat angle	580	10
0107 89	90° flat angle	1924	5
0107 92	90° flat angle	2470	2

End cap

0107 02	Left or right end cap	144	20/100
0107 06	Left or right end cap	280	10/50
0107 07	Left or right end cap	330	5/50
0107 22	Left or right end cap	156	10

Junctions

0107 32	Flat junctions to tap-off to a branch smaller than 50 x 105	720	10
0107 35	For specific size tap-off to 80 mm wide branch	418	5
0107 36	For tap-off to an 105 mm wide branch equipped with an 85 mm cover	414	5/25
0107 37	Flat junction for specific size - tap off to an 105 mm wide branch with 65 mm cover	414	5/25

DLP PVC trunking system and accessories - trunking and fittings

Cat.Nos	Description	MRP* ₹ / Unit	Pack
---------	-------------	------------------	------

Junctions

Partition junction

0106 11	For internal angles	242	5/50
0106 32	For external angles	364	5/50
0107 42	For flat angles	860	5/25

Accessories

Holding cables in place

0106 82	Clip for 65 mm width cover	56	50
0106 86	Clip for 130 mm width cover	96	50

VDI accessories

0107 80	For internal angles	622	5/50
0107 81	For external angles	670	5/50
0107 82	For flat angles	712	5/50
0107 83	For flat junctions	856	5/50

Additional accessories

0106 98	Wall crossing for trunking 80 to 150 mm width	690	5/25
0106 99	Wall crossing for trunking 195 mm width	718	5/25
0308 81	Cable tie base	24	100/1000
0111 88	Earthing link	260	20/500

Capacity Change

Allows to increase 15 mm height of trunking to preserve the space of wiring with a flat junction or a support equipment

0106 87	Raise, length 57 cm	248	40
0106 88	Set of 4 accessories to change capacity of the body	312	10/100
0106 89	Set of 2 accessories to change height of partition (to be used)	314	5/50

Supports for mounting wiring accessories

Arteor™ supports

Clip-on supports which can be fitted side by side
Supplied with finishing plate

0109 10	1 modules-for 40 mm cover	142	5/50
0109 21	2 modules-for 65 mm cover	136	20
0109 22	2 modules-for 85 mm cover	140	20
0109 31	3 modules-for 65 mm cover	190	5/50
0109 32	3 modules-for 85 mm cover	202	5/50
0109 41	4 modules-for 65 mm cover	206	10/50
0109 42	4 modules-for 85 mm cover	206	20
0109 61	6 modules-for 65 mm cover	242	5/25
0109 62	6 modules-for 85 mm cover	272	10
0109 27	Insulation unit for 2 modules (Arteor™) can be fitted together to create 4/6/8 module supports	244	10/100

Legrand Lexic supports

0109 25	For 2 modules for 65 mm cover (2 comp.)	846	5
0109 35	For 3 modules for 85 mm cover (2 comp.)	1002	5
0109 65	For 6 modules for 130 mm cover (1 comp.)	1124	5
0109 00	Hydra socket support - for 130 mm cover	1626	5

* MRP - Maximum Retail Price Inclusive of all taxes including GST.
(1) Price in Meters; No of meters in Pack, Standard length 2 meters to be ordered in multiples of 2 meters

Bold Cat.Nos are products normally available with Legrand (India) Stockists. Cat.Nos that are not bold - delivery within 4 - 8 weeks from the date of order. Bold packing quantity is our mandatory packing. Orders to be placed by Legrand (India) Stockist in multiples of the same.

DLP-S PVC trunking system and accessories - trunking and fittings

Cat.Nos	Description	MRP* ₹ / Unit	Pack
---------	-------------	------------------	------

Trunking

Body with cover

6380 38	100 x 50	830	12 ⁽¹⁾
---------	----------	-----	-------------------

Partition

6380 08	Separation Partition	152	32 ⁽¹⁾
---------	----------------------	-----	-------------------

Joints

6380 36	Body / Base Joint	52	10
6380 01	Cover joint	138	50

Angles and end caps

Variable angles

6380 31	Variable Internal Angle	320	10
6380 32	Variable External Angle	320	10

Fixed angles

6380 11	Fixed Internal Angle	206	20
6380 12	Fixed External Angle	208	20

Flat angle

6380 13	Flat Angle	454	16
---------	------------	-----	----

End cap

6380 35	End Cap	118	20
---------	---------	-----	----

Bracket

6380 05	Universal Bracket (set of 2 pcs.)	102	10/100
---------	--------------------------------------	-----	--------

Junction

6380 34	Tee / Flat Junction	1000	5
---------	---------------------	------	---

Supports for mounting wiring accessories

Arteor™ & Myrius supports

Clip-on supports which can be fitted side by side
Supplied with finishing plate

6380 71	2 modules frame	146	10
6380 72	4 modules frame	202	5
6380 73	6 modules frame	292	5

DLP aluminium adaptable trunking system

Body

0111 00	Supplied without cover	3488	8 ⁽¹⁾
0111 02	Supplied without cover Allow fitting of partial covers - 2 compartments	4392	4 ⁽¹⁾
0111 04	Supplied without cover allow fitting of partial covers - 2 compartments	5150	4 ⁽¹⁾

Cover and partition

0111 10	Rigid cover 65 mm width	868	16 ⁽¹⁾
0111 11	Rigid cover 85 mm width	1138	16 ⁽¹⁾
0111 08	Separation partition	600	24 ⁽¹⁾
0111 06	Clip on Partition	1076	12 ⁽¹⁾

Finishing accessories

0111 66	Base / Body joint	204	20/100
0111 62	Cover joint - 65 mm	282	10
0111 63	Cover joint - 85 mm	300	10/100
0111 58	End cap	614	20/100
0111 60	End cap	1316	10
0111 61	End cap	1560	10
0112 43	Flat angle for 85 mm cover	5292	10
0112 45	Flat angle for cover 65/130 mm	8910	5

* MRP - Maximum Retail Price Inclusive of all taxes including GST.
(1) Price in Meters; No of meters in Pack, Standard length 2 meters to be ordered in multiples of 2 meters

DLP aluminium adaptable trunking system - trunking and fittings

Cat.Nos	Description	MRP* ₹ / Unit	Pack
---------	-------------	------------------	------

Finishing accessories

0112 47	Flat angle for cover 85/180 mm	9188	2
0112 32	External angle for 85 mm cover	6598	1
0112 38	External angle 2 cover 65 mm	13660	1
0112 40	External angle 2 covers 85mm	14264	1
0112 21	Internal angle for 85 mm cover	5936	1
0112 27	Internal angle 2 Covers 65 mm	13560	1
0112 29	Internal angle 2 Cover 85 mm	14162	1
0112 51	Flat junction To tap off to 105 mm wide trunking equipped with 85 mm cover	7182	5

Supports for Arteor™ for cover 85 mm width

0112 12	2 modules	430	20
0112 13	3 modules	504	20
0112 14	4 modules	506	20
0112 16	6 modules	674	10

Supports for Arteor™ for cover 65 mm width

0112 02	2 modules	390	20
0112 03	3 modules	478	20
0112 04	4 modules	496	20
0112 06	6 modules	582	10

Cabling accessories

0106 82	Clip for 65 mm and 85 mm covers	56	50
0111 88	Earth link	260	20
0308 81	Base for cable ties	24	100

Aluminium snap-on columns

Columns

74 x 80 mm - 1 compartment

6038 00	Height 2.70 m Can be adapted to a ceiling height up to 3.70 m	23800	1
6038 02	Height 3.70 m Can be adapted to a ceiling height up to 4.70 m	27788	1

81 x 130 mm - 2 compartments

6038 01	Height 2.70 m Can be adapted to a ceiling height up to 3.70 m	32974	1
6038 03	Height 3.70 m Can be adapted to a ceiling height up to 4.70 m	38846	1

Separation partition for 74 x 80 and 81 x 130 Snap-on columns

6038 07	Height 60 mm	436	36 ⁽¹⁾
---------	--------------	-----	-------------------

Mini-column

6038 05	81x130mm - 2 compartments Height 0.68 m Can be associated with floor trunking range	13668	1
---------	--	-------	---

Other accessories

0111 88	Accessory - Earth Link	260	20
6038 57	Fixing CLIP- Signal White (Set of 2pcs)	194	10
6038 58	Fixing CLIP - Grey / Anthracite (Set of 2pcs)	548	10

Bold Cat.Nos are products normally available with Legrand (India) Stockists.
Cat.Nos that are not bold - delivery within 4 - 8 weeks from the date of order.
Bold packing quantity is our mandatory packing. Orders to be placed by
Legrand (India) Stockist in multiples of the same.

AUDIO/VIDEO
PRETERMINATED SOCKETS

The right system to meet your needs

A wide range of technologies (HD15, HDMI, DISPLAY PORT, RCA, JACK)
to suit the location and the user requirements

INSTALLATION EXAMPLE WITH HD15 PRETERMINATED SOCKET AND VIDEO PROJECTOR SWITCH

1 Quick
installation

2 Easy
connection

3 Optimum
performance



1 Infrared ON/STANDBY control
for video projector associated
with a pushbutton
Cat.No 0 787 99/5 720 89

2 3 Preterminated HD15 sockets
Cat.No 0 787 77/5 720 97

4 10 m male/male HD15 cords
Cat.No 0 517 23

5 6 Male/male HD 15 cords

NEW TOOLLESS CONNECTOR CONNECTION PHASES



Take the wire housing

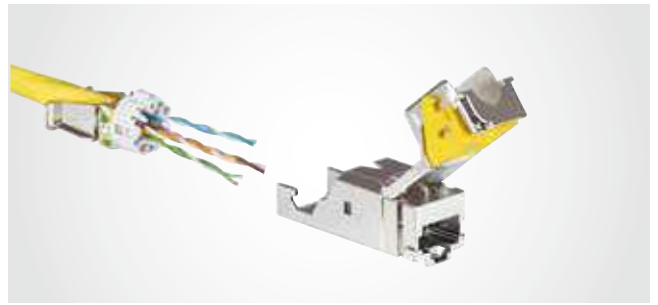

Pass the cable through the back of the wire housing

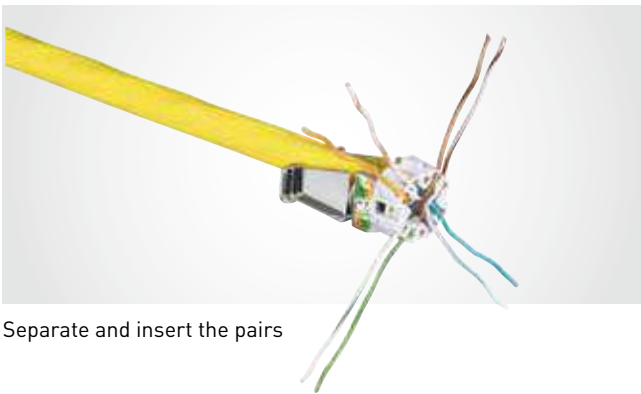

Separate and insert the pairs



Cut the pairs



Install the wire housing without pushing



Push down the lever and lock the connector

FIBRE OPTIC SYSTEM

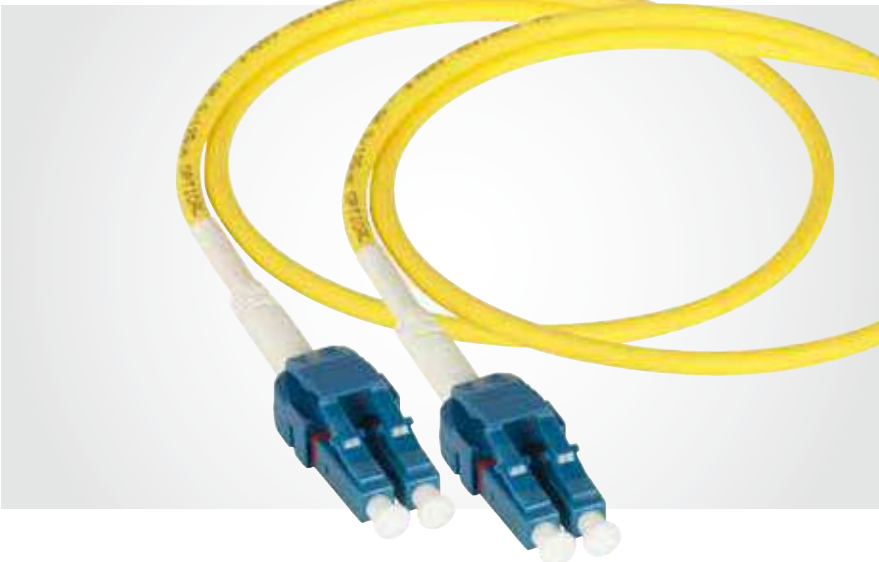

FIBRE OPTIC PANELS



Modular panels



HD modular panels

CORD LOCKING SYSTEM



AN INNOVATIVE TECHNICAL SOLUTION









LCS³

From technical room to workstation

Complete systems with a 20-year guarantee. The new LCS³ cat. 6A (up to 500 mHz), cat. 6 (up to 250 mHz) and cat. 5e (up to 100 mHz) systems have been designed as coherent entities to optimise their performance. The systems are suitable for optical fibre cables as well as copper cables.



The new LCS³ systems integrate perfectly in the various other Legrand solutions: DLP trunking system, cabling accessories, cable management, etc.

Legrand cabling system LCS³ category 8

Cat.Nos	Description	MRP* ₹ / Unit	Pack
Cat. 8 patch panel equipped with 24 RJ 45 connectors			
Flat panel			
 0337 82	STP panel - Metal shielding	■	1
Flat 24-connector patch panels - 1 U to be equipped			
Flat panel with empty cassettes to be equipped with connectors			
Equipped with 4 automatic extraction cassette for cat. 5e to cat. 8 RJ 45 connectors			
 0337 90	19" patch panel - 1 U	■	1
Empty flat panel to be equipped with cassette			
It can accept a maximum of 4 automatic extraction cassettes: - copper - fibre optic			
0337 91	19" patch panel - 1 U	■	1
Angled 24-connector patch panel - 1 U			
Angled panel to be equipped with connectors			
It can accept up to 24 cat. 5e to cat. 8 RJ 45 connectors			
 0337 92	19" panel - 1 U	■	
Cat. 8 RJ 45 connectors for flat and angled STP panel			
 0337 85	Set of 6 RJ 45 connectors For installation in the cassettes of flat or angled panels	■	1
Common accessories for flat and angled panels			
Port blanking modules			
 0337 56	Divisible 6 port blanking plate for sealing from 1 to 6 ports	■	10
Cord management			
 0337 59	2 cord management for use with new generation Quick-Fix They provide side cord management	■	1
Specific accessories for flat panels			
Cassette for flat panels to be equipped			
 0337 55	Empty removable cassette to be equipped with connectors. It can accept 6 cat. 5e to cat. 8 connectors. Extraction by simple pressure of the cassette making installation and maintenance easier	■	1
 0337 57	Used to blank the panel	■	1

* MRP - Maximum Retail Price Inclusive of all taxes including GST.
■ Price available on request.
(1) in meters

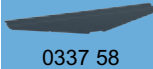
Legrand cabling system LCS³ category 8

Cat.Nos	Description	MRP* ₹ / Unit	Pack
Specific accessories for angled panels			
Angled panel cover			
 0337 58	For optimised management of the air flow inside the cabinet	■	1
Cat. 8 local network cables			
F/UTP - 4 pairs			
Performance 2000 MHz			
0337 86	Length 500 m supplied on drum. Weight 42 kg	■	500 ¹
S/FTP - 4 pairs			
Performance 2000 MHz			
0337 88	Length 500 m supplied on drum. Weight 45 kg	■	500 ¹
Cat. 8 RJ 45 patch cords			
S/FTP shielded, impedance 100 Ω			
LSZH - RAL 6027			
0337 01	Length 0.5 m	■	
0337 02	Length 1 m	■	
0337 03	Length 2 m	■	
0337 04	Length 3 m	■	
0337 05	Length 5 m	■	
0337 06	Length 8 m	■	
0337 07	Length 10 m	■	
LSZH - RAL 3020			
0337 21	Length 0.5 m	■	1
0337 22	Length 1 m	■	
0337 23	Length 2 m	■	
0337 24	Length 3 m	■	
0337 25	Length 5 m	■	
0337 26	Length 8 m	■	
0337 27	Length 10 m	■	1
LSZH - RAL 6026			
0337 08	Length 0.5 m	■	1
0337 09	Length 1 m	■	
0337 10	Length 2 m	■	
0337 11	Length 3 m	■	
0337 12	Length 5 m	■	
0337 13	Length 8 m	■	
0337 17	Length 10 m	■	1
Marking kit			
 0518 90	Kit of 200 coloured rings for marking RJ 45 cords Rings to be clipped to the patch cords	■	1
Legrand cabling system LCS³ category 6_A			
Cat. 6_A patch panels equipped with 24 RJ 45 connectors			
Flat panels			
24 RJ 45 connectors - 1 U			
0337 70	UTP	■	1
0337 72	STP	■	1

Bold Cat.Nos are products normally available with Legrand (India) Stockists. Cat.Nos that are not bold - delivery within 4 - 8 weeks from the date of order. Bold packing quantity is our mandatory packing. Orders to be placed by Legrand (India) Stockist in multiples of the same.

Legrand cabling system LCS³

category 6_A

Cat.Nos	Description	MRP* ₹ / Unit	Pack
---------	-------------	------------------	------

Flat 24-connector patch panels - 1 U to be equipped

Flat panel with empty cassettes to be equipped with connectors

Equipped with 4 automatic extraction cassettes for cat. 5e to cat. 8 RJ 45 connectors



0337 90

0337 90	19" panel - 1 U	■	1
---------	-----------------	---	---

Empty flat panel to be equipped with cassettes

It can accept a maximum of 4 automatic extraction cassettes:

- copper
- fibre optic

0337 91	19" panel - 1 U	■	1
---------	-----------------	---	---

Flat high density 48-connector patch panel - 1 U to be equipped



0337 93

0337 93	19" panel - 1 U	■	1
---------	-----------------	---	---

Angled 24-connector patch panel - 1 U

Angled panel to be equipped with connectors

It can accept up to 24 cat. 5e to cat. 8 RJ 45 connectors



0337 92

0337 92	19" panel - 1 U	■	1
---------	-----------------	---	---

Angled high density 48-connector patch panel - 1 U to be equipped

Angled panel to be equipped with connectors

It can accept up to 48 cat. 5e to cat. 6A RJ 45 connectors



0337 94

0337 94	19" panel - 1 U	■	1
---------	-----------------	---	---

High density cat. 6A RJ 45 connectors



0337 75

0337 73	UTP	■	1
0337 75	STP	■	1

Common accessories for flat and angled panels

Port blanking modules



0337 56

0337 56	Divisible 6 port blanking plate for sealing from 1 to 6 ports	■	10
---------	---	---	----

Cord management



0337 59

0337 59	For use with new generation Quick-Fix; they provide side cord management	■	1
---------	--	---	---

Specific accessories for flat panels

Cassette for flat panels to be equipped



0337 55

0337 55	Empty removable cassette to be equipped with connectors. It can accept 6 cat. 5e to cat. 8 connectors Extraction by simple pressure of the cassette making installation and maintenance easier Possibility of removing each connector individually	■	1
---------	--	---	---

* MRP - Maximum Retail Price Inclusive of all taxes including GST.

■ Price available on request.

(1) in meters

Legrand cabling system LCS³

category 6_A

Cat.Nos	Description	MRP* ₹ / Unit	Pack
---------	-------------	------------------	------

High density cassette for flat panels to be equipped

0337 95	Empty removable cassette to be equipped with connectors; it can accept 12 cat. 5e to cat. 6 _A connectors Extraction by simple pressure of the cassette, making installation and maintenance easier	■	1
---------	--	---	---

Blanking cassette



0337 57

0337 57	Used to blank the panel	■	1
---------	-------------------------	---	---

Specific accessories for angled panels

Angled panel cover



0337 58

0337 58	For optimised management of the air flow inside the cabinet	■	1
---------	---	---	---

Cables for local networks cat. 6A

LSZH - U/UTP - 4 pairs

Performance 500 MHz

0327 87	Length 500 m Supplied on reel. Weight 25 kg	■	500 ¹
---------	---	---	------------------

F/UTP - 4 pairs

Performance 500 MHz

0327 78	Length 500 m Supplied on reel. Weight 25 kg	■	500 ¹
---------	---	---	------------------

F/UTP - 2 x 4 pairs

Performance 500 MHz

0328 78	Length 500 m Supplied on reel. Weight 65 kg	■	500 ¹
---------	--	---	------------------

S/FTP - 4 pairs

Performance 600 MHz

0327 77	Length 500 m Supplied on reel. Weight 30 kg	■	500 ¹
---------	--	---	------------------



0327 77

RJ 45 patch cords and user cords cat. 6A

PVC - U/UTP unshielded impedance 100

0518 82	Length 1 m	■	1
0518 83	Length 2 m	■	1
0518 84	Length 3 m	■	1
0518 85	Length 5 m	■	1

LSZH - U/UTP unshielded impedance 100

0518 78	Length 1 m	■	1
0518 79	Length 2 m	■	1
0518 80	Length 3 m	■	1
0518 81	Length 5 m	■	1
0518 74	Length 1 m	■	1
0518 75	Length 2 m	■	1
0518 76	Length 3 m	■	1
0518 77	Length 5 m	■	1

PVC - S/FTP shielded impedance 100

0518 16	Length 0.5 m	■	1
---------	--------------	---	---

Bold Cat.Nos are products normally available with Legrand (India) Stockists. Cat.Nos that are not bold - delivery within 4 - 8 weeks from the date of order. Bold packing quantity is our mandatory packing. Orders to be placed by Legrand (India) Stockist in multiples of the same.

Legrand cabling system LCS³ category 6_A

Cat.Nos	Description	MRP* ₹ / Unit	Pack
---------	-------------	------------------	------

PVC - S/FTP shielded impedance 100

0517 80	Length 1 m	■	5
0517 81	Length 2 m	■	5
0517 82	Length 3 m	■	5
0517 83	Length 5 m	■	5

LSZH - S/FTP shielded impedance 100

0518 70	Length 1 m	■	1
0518 71	Length 2 m	■	1
0518 72	Length 3 m	■	1
0518 73	Length 5 m	■	1
0518 66	Length 1 m	■	1
0518 67	Length 2 m	■	1
0518 68	Length 3 m	■	1
0518 69	Length 5 m	■	1

Arteor RJ 45 socket cat. 6_A

360° metal shielding

STP - 1 module

5734 32	White	■	20
5728 06	Magnesium	■	10
5723 52	White with green shutter	■	10
5728 52	Magnesium with green shutter	■	10
5723 51	White with orange shutter	■	10
5728 51	Magnesium with orange shutter	■	10

STP with controlled access - 2 modules

Supplied with 2 keys for 5 sockets

5723 50	White with red shutter	■	5
5728 50	Magnesium with red shutter	■	5

UTP - 1 module

5723 49	White	■	10
5728 49	Magnesium	■	10
5723 59	White with green shutter	■	10
5728 59	Magnesium with green shutter	■	10
5723 58	White with orange shutter	■	10
5728 58	Magnesium with orange shutter	■	10

UTP with controlled access - 2 modules

Supplied with 2 keys for 5 sockets

5723 57	White with red shutter	■	5
5728 57	Magnesium with red shutter	■	5

Legrand cabling system LCS³ category 6

Cat. 6 patch panels equipped with 24 RJ 45 connectors

Flat panels

24 RJ 45 connectors - 1 U

0337 60	UTP	■	1
0337 61	FTP	■	1
0337 62	STP	■	1

* MRP - Maximum Retail Price Inclusive of all taxes including GST.

■ Price available on request.

(1) in meters

Legrand cabling system LCS³ category 6

Cat.Nos	Description	MRP* ₹ / Unit	Pack
---------	-------------	------------------	------

Flat 24-connector patch panels - 1 U to be equipped

Flat panel with empty cassettes to be equipped with connectors

Equipped with 4 automatic extraction cassettes for cat. 5e to cat. 8 RJ 45 connectors

0337 90	19" panel - 1 U	■	1
---------	-----------------	---	---

Empty flat panel to be equipped with cassettes

It can accept a maximum of 4 automatic extraction cassettes:

- copper
- fibre optic

0337 91	19" patch panel - 1 U	■	1
---------	-----------------------	---	---

Flat high density 48-connector patch panel - 1 U to be equipped

0337 93	19" panel - 1 U	■	1
---------	-----------------	---	---

Angled 24-connector patch panels - 1 U

Angled panel to be equipped with connectors

It can accept up to 24 cat. 5e to cat. 8 RJ 45 connectors

0337 92	19" panel - 1 U	■	1
---------	-----------------	---	---

Angled high density 48-connector patch panel - 1 U to be equipped

Angled panel to be equipped with connectors

It can accept up to 48 cat. 5e to cat. 6_A RJ 45 connectors

0337 94	19" panel - 1 U	■	1
---------	-----------------	---	---

Cat. 6 high density RJ 45 connectors

0337 63	UTP	■	1
0337 64	FTP	■	1
0337 65	STP	■	1

Common accessories for flat and angled panels

Port blanking modules

0337 56	Divisible 6 port blanking plate for sealing from 1 to 6 ports	■	10
---------	---	---	----

Cord management

0337 59	For use with new generation Quick-Fix; they provide side cord management	■	1
---------	--	---	---

Specific accessories for flat panels

0337 55	Cassette for flat panels to be equipped	■	1
0337 95	High density cassette for flat panels to be equipped	■	1
0337 57	Blanking cassette Used to blank the panel	■	1

Bold Cat.Nos are products normally available with Legrand (India) Stockists. Cat.Nos that are not bold - delivery within 4 - 8 weeks from the date of order. Bold packing quantity is our mandatory packing. Orders to be placed by Legrand (India) Stockist in multiples of the same.

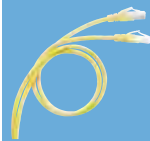

0517 82



5734 32



5723 57



0337 61



0337 90



0337 93



0337 92



0337 94



0337 63



0337 56



0337 59



0337 55

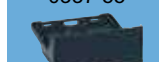

0337 95

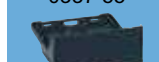

0337 57

Legrand cabling system LCS³ category 6

Cat.Nos	Description	MRP* ₹ / Unit	Pack
---------	-------------	------------------	------

Specific accessories for angled panels

Angled panel cover

0337 58	For optimised management of the air flow inside the cabinet	■	
---------	---	---	--

0337 58

Cables for cat. 6 LANs

Cables with 4 pairs or 2 x 4 twisted pairs
100 ohms. Colour code TIA/EIA
Conform to standards ISO/IEC 11801
Ed. 2.0, EN 50173-1 and TIA/EIA 568 C

LSZH - U/UTP - 4 pairs

0327 54I	Length 305 m. Supplied in cardboard box Weight 16 kg., Violet RAL 4005	■	305 ¹
0328 61	Length 500 m. Supplied on reel. Weight 18 kg. Blue RAL 5015	■	500 ¹

PVC - U/UTP - 4 pairs

0327 55W	Length 305 m Supplied in cardboard box, Weight 13 kg., White RAL 9003, MOQ 50 Box	■	305 ¹
0327 55	Length 305 m Supplied in cardboard box Weight 13 kg. Blue RAL 5015	■	305 ¹
0327 55O	Length 305 m Supplied in cardboard box, Weight 13 kg., Orange RAL 2008, MOQ 50 Box	■	305 ¹
0327 55G	Length 305 m Supplied in cardboard box, Weight 13 kg., Green RAL 6018/6024, MOQ 50 Box	■	305 ¹

LSZH - U/UTP - 4 pairs

0327 54	Length 305 m Supplied in cardboard box. Weight 16 kg	■	305 ¹
0328 61	Length 500 m Supplied on reel. Weight 18 kg	■	500 ¹

0327 54

PVC - U/UTP - 4 pairs

0327 55	Length 305m Supplied in cardboard box. Weight 13 kg	■	305 ¹
---------	---	---	------------------

LSZH - F/UTP - 4 pairs

0328 56	Length 305 m. Supplied on reel. Weight 17 kg	■	305 ¹
0327 56	Length 500 m. Supplied on reel. Weight 25 kg	■	500 ¹

PVC - F/UTP - 4 pairs

0328 57	Length 305 m Supplied in cardboard box. Weight 17 kg	■	305 ¹
0327 58	Length 500 m Supplied on reel. Weight 25 kg	■	500 ¹

LSZH - F/UTP - 2 x 4 pairs

0327 76	Length 500 m. Supplied on reel. Weight 48 kg	■	500 ¹
---------	--	---	------------------

* MRP - Maximum Retail Price Inclusive of all taxes including GST.

■ Price available on request.

(1) in meters

Legrand cabling system LCS³ category 6

Cat.Nos	Description	MRP* ₹ / Unit	Pack
---------	-------------	------------------	------

LSZH - SF/UTP - 4 pairs

0327 57	Length 500 m. Supplied on reel. Weight 29 kg	■	500 ¹
---------	--	---	------------------

PVC - SF/UTP - 4 pairs

0327 59	Length 500 m. Supplied on reel. Weight 30 kg	■	500 ¹
---------	--	---	------------------

LSZH - F/FTP - 2 x 4 pairs

0327 98	Length 500 m. Weight 62 kg	■	
---------	----------------------------	---	--

PVC - F/FTP - 4 pairs

0327 99	Length 500 m. Weight 25,2 kg	■	
---------	------------------------------	---	--

RJ 45 patch cords and user cords cat. 6

RJ 45 - RJ 45 right

PVC - U/UTP unscreened impedance 100

0518 18	Length 0.5 m	■	1
0517 72	Length 1 m	■	1
0517 73	Length 2 m	■	1
0517 74	Length 3 m	■	1
0517 75	Length 5 m	■	1

LSZH - U/UTP unscreened impedance 100

0518 62	Length 1 m	■	1
0518 63	Length 2 m	■	1
0518 64	Length 3 m	■	1
0518 65	Length 5 m	■	1
0518 58	Length 1 m	■	1
0518 59	Length 2 m	■	1
0518 60	Length 3 m	■	1
0518 61	Length 5 m	■	1

PVC - F/UTP screened impedance 100

0518 15	Length 0.5 m	■	1
0517 62	Length 1 m	■	1
0517 63	Length 2 m	■	1
0517 64	Length 3 m	■	1
0517 65	Length 5 m	■	1

LSZH - F/UTP screened impedance 100

0518 54	Length 1 m	■	1
0518 55	Length 2 m	■	1
0518 56	Length 3 m	■	1
0518 57	Length 5 m	■	1
0518 50	Length 1 m	■	1
0518 51	Length 2 m	■	1
0518 52	Length 3 m	■	1
0518 53	Length 5 m	■	1

PVC - SF/UTP shielded impedance 100

0517 52	Length 1 m	■	5
0517 53	Length 2 m	■	5
0517 54	Length 3 m	■	5
0517 55	Length 5 m	■	5

Bold Cat.Nos are products normally available with Legrand (India) Stockists. Cat.Nos that are not bold - delivery within 4 - 8 weeks from the date of order. Bold packing quantity is our mandatory packing. Orders to be placed by Legrand (India) Stockist in multiples of the same.

Legrand cabling system LCS³ category 6

Cat.Nos	Description	MRP* ₹ / Unit	Pack
---------	-------------	------------------	------

RJ 45 sockets

Sockets with LCS³ quick-fixing crimp connector. Take AWG 22 single-core cables up to AWG 26 and AWG 24 multicore cables. Contacts marked with dual colour code and wiring schemes T 568 A and T 568 B. Conforming to standards ISO/IEC 11801 Ed. 2.0, EN 50173-1 and TIA/EIA 568

Arteor RJ 45 socket cat. 6

UTP - 1 module

5734 28	White	■	20
5736 28	Magnesium	■	20
5723 54	White with orange shutter	■	10
5728 54	Magnesium with orange shutter	■	10
5723 55	White with green shutter	■	10
5728 55	Magnesium with green shutter	■	10

UTP - 2 modules

5734 74	White	■	10
5736 74	Magnesium	■	10

UTP - 2 modules - round

5723 24	White	■	10
5728 24	Magnesium	■	10

UTP with controlled access - 2 modules

Supplied with 2 keys for 5 sockets

5723 53	White with red shutter	■	5
5728 53	Magnesium with red shutter	■	5

UTP retractable RJ 45 sockets - 4 modules

With integrated retractable cord (0.9 m)
Winds up automatically with a pushbutton

5723 39	White	■	1
5728 39	Magnesium	■	1

FTP - 1 module

5723 22	White	■	10
5728 22	Magnesium	■	10

FTP - 2 modules

5734 76	White	■	10
5736 76	Magnesium	■	10

Shielded STP - 1 module

5734 34	White	■	10
5736 34	Magnesium	■	10

Shielded STP - 2 modules

5734 77	White	■	10
5736 77	Magnesium	■	10

Mylic RJ 45 socket cat. 6

UTP - 1 module

6755 45	White	■	20
---------	-------	---	----

* MRP - Maximum Retail Price Inclusive of all taxes including GST.

■ Price available on request.

(1) in meters



5736 28



5728 24



6755 45

Legrand cabling system LCS³ category 6

Cat.Nos	Description	MRP* ₹ / Unit	Pack
---------	-------------	------------------	------

Myrius RJ 45 sockets cat. 6

UTP - 1 module

6730 55	White	■	20
6731 55	Black	■	20

UTP - 2 modules

6730 56	White	■	20
6731 56	Black	■	20

Soliroc RJ 45 sockets cat. 6 - IK 10

0778 91	IP 20 For at-risk areas or areas with no surveillance FTP socket	■	10
---------	--	---	----

Plexo RJ 45 sockets cat. 6 - IP 55 closed flap IK 07

Protection against water, dust. For industrial sites

0695 69	FTP socket Grey/white	■	5/100
0695 61	UTP socket Grey/white	■	1/20
0695 81	Adaptor for RJ 45 socket Weatherproofing ensured (IP 44) plug inserted Grey/white	■	1

Plexo 66 RJ 45 socket cat. 6 - IP 66 - IK 08

FTP socket

0904 67	9 contacts Weatherproofing ensured (IP 66) with plug inserted Inclined 90° Grey RAL 7016/T029	■	1
---------	---	---	---

Patch panels cat. 6

6327 91	24 x RJ 45 connectors, for unshielded keystone	■	1
---------	--	---	---

Keystone RJ 45 sockets cat. 6

0765 88	Cat 6 UTP socket with fast connection thanks to integrated crimping	■	10
---------	---	---	----

Surface mounting box

1 or 2 ports

6327 79	For keystone connectors Provides solution for integration of keystone in surface mounting installations	■	20
---------	---	---	----

Cables for cat 6 LANs 24 AWG

U/UTP - 4 Pairs

6327 24	Length 305 m Supplied in cardboard box Weight 16 kg. Dark grey RAL 7037	■	305
6327 24W	Length 305 m Supplied in cardboard box Weight 16 kg. White RAL 9003. MOQ - 50 box	■	305
6327 24O	Length 305 m Supplied in cardboard box Weight 16 kg. Orange RAL 2008 MOQ 50 Box	■	305
6327 24G	Length 305 m Supplied in cardboard box Weight 16 kg. Green RAL 6018 / 6024 MOQ 50 Box	■	305



6730 56



0778 91



0695 69



0904 67



6327 91



0765 88

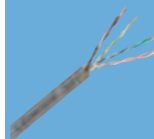

6327 24

Bold Cat.Nos are products normally available with Legrand (India) Stockists. Cat.Nos that are not bold - delivery within 4 - 8 weeks from the date of order. Bold packing quantity is our mandatory packing. Orders to be placed by Legrand (India) Stockist in multiples of the same.

Legrand cabling system LCS³ category 6

Cat.Nos	Description	MRP* ₹ / Unit	Pack
---------	-------------	------------------	------

Patch cords

RJ 45 - RJ 45
PVC

U/UTP cat. 6 unscreened impedance 100 Ω

Light blue

6327 50	Length 1 m	■	20
6327 51	Length 1.5 m	■	20
6327 52	Length 2 m	■	20
6327 53	Length 3 m	■	20
6327 54	Length 5 m	■	20

F/UTP cat. 6 screened impedance 100 Ω

Blue-green

6327 60	Length 1 m	■	20
6327 61	Length 2 m	■	20
6327 62	Length 3 m	■	20
6327 63	Length 5 m	■	20

Legrand cabling system LCS³ category 5e

**Cat. 5e patch panels equipped with
24 RJ 45 connectors**

**Flat panel with empty cassettes to be equipped with
connectors**

24 RJ 45 connectors - 1 U

0337 50	UTP	■	1
0337 51	FTP	■	1

**Flat 24-connector patch panels -
1 U to be equipped**

**Flat panel with empty cassettes to be equipped with
connectors**

Equipped with 4 automatic extraction cassettes for cat. 5e to cat. 8 RJ 45 connectors

0337 90	19" panel - 1 U	■	1
---------	-----------------	---	---

Empty flat panel to be equipped with cassettes

It can accept a maximum of 4 automatic extraction cassettes:

- copper
- fibre optic

0337 91	19" panel - 1 U	■	1
---------	-----------------	---	---

**Flat high density 48-connector patch panel -
1 U to be equipped**

0337 93	19" panel - 1 U	■	1
---------	-----------------	---	---

Angled 24-connector patch panel - 1 U

Angled panel to be equipped with connectors

It can accept up to 24 cat. 5e to cat. 8 RJ 45 connectors

0337 92	19" panel - 1 U	■	1
---------	-----------------	---	---

**Angled high density 48-connector
patch panel - 1 U to be equipped**

0337 94	19" panel - 1 U	■	1
---------	-----------------	---	---

* MRP - Maximum Retail Price Inclusive of all taxes including GST.

■ Price available on request.

(1) in meters

Legrand cabling system LCS³ category 5e

Cat.Nos	Description	MRP* ₹ / Unit	Pack
---------	-------------	------------------	------

Cat. 5e High density RJ 45 connectors

0337 53	UTP	■	1
0337 54	FTP	■	1

Common accessories for flat and angled panels

Port blanking modules

0337 56	Divisible 6 port blanking plate for sealing from 1 to 6 ports	■	10
---------	---	---	----

Cord management

0337 59	For use with new generation Quick-Fix They provide side cord management	■	1
---------	---	---	---

Specific accessories for flat panels

0337 55	Cassette for flat panels to be equipped	■	1
0337 95	High density cassette for flat panels to be equipped	■	1
0337 57	Blanking cassette Used to blank the panel	■	1

Specific accessories for angled panels

Angled panel cover

0337 58	For optimised management of the air flow inside the cabinet	■	1
---------	---	---	---

Cables for local networks cat. 5e

LSZH - U/UTP - 4 pairs

0327 50	Length 305 m Supplied in cardboard box. Weight 10 kg	■	305 ¹
0328 53	Length 500 m Supplied on reel. Weight 15 kg	■	500 ¹

PVC - U/UTP - 4 pairs

0327 51	Length 305 m Supplied in cardboard box. Weight 9 kg	■	305 ¹
---------	---	---	------------------

LSZH - F/UTP - 4 pairs

0327 52	Length 305 m Supplied in cardboard box. Weight 12 kg	■	305 ¹
0328 50	Length 500 m Supplied on reel. Weight 21 kg	■	500 ¹

PVC - F/UTP - 4 pairs

0327 53	Length 305 m Supplied by box. Weight 11 kg	■	305 ¹
---------	--	---	------------------

RJ 45 patch cords and user cords cat. 5e

RJ 45 - RJ 45 right

PVC - U/UTP unscreened impedance 100 Ω

Grey

0518 17	Length 0.5 m	■	1
0516 36	Length 1 m	■	1
0516 37	Length 2 m	■	1

Bold Cat.Nos are products normally available with Legrand (India) Stockists. Cat.Nos that are not bold - delivery within 4 - 8 weeks from the date of order. Bold packing quantity is our mandatory packing. Orders to be placed by Legrand (India) Stockist in multiples of the same.

Legrand cabling system LCS³ category 5e

Cat.Nos	Description	MRP* ₹ / Unit	Pack
---------	-------------	------------------	------

PVC - U/UTP unscreened impedance 100 Ω

Grey

0516 38	Length 3 m	■	1
0516 39	Length 5 m	■	1

F/UTP screened impedance 100

Grey

0518 14	Length 0.5 m	■	1
0516 40	Length 1 m	■	1
0516 41	Length 2 m	■	1
0516 42	Length 3 m	■	1
0516 43	Length 5 m	■	1

Myrius RJ 45 sockets cat. 5e

UTP - 1 module

6730 54	White	■	20
6731 54	Black	■	20

Mylinc RJ 45 sockets cat. 5e

UTP - 1 module

6755 47	White	■	20
---------	-------	---	----

Arteor RJ 45 socket cat. 5e

UTP - 1 module

5734 29	White	■	20
5736 29	Magnesium	■	20

UTP - 2 modules

5734 75	White	■	10
5736 75	Magnesium	■	20

FTP - 1 module

5734 30	White	■	20
5736 30	Magnesium	■	20

Plexo RJ 45 sockets, cat. 5e - IP 55 closed flap IK 07

Protection against water, dust
For industrial sites

0695 57	FTP socket Grey/White	■	1/20
0695 56	UTP socket Grey/White	■	1/20
0695 81	Adaptor for RJ 45 socket Ensures weatherproofing (IP 44) with the plug inserted Grey/White	■	1

Patch panels cat. 5e

6327 91	24 x RJ 45 connectors, for unshielded keystone	■	1
---------	---	---	---

Keystone RJ 45 sockets cat. 5e

0765 87	Cat 5e UTP socket with fast connection thanks to integrated crimping	■	10
---------	--	---	----

Surface mounting box

1 or 2 ports

6327 79	For keystone connectors Provides solution for integration of keystone in surface mounting installations	■	20
---------	---	---	----

* MRP - Maximum Retail Price Inclusive of all taxes including GST.

■ Price available on request.

(1) in meters

Legrand cabling system LCS³ category 5e

Cat.Nos	Description	MRP* ₹ / Unit	Pack
---------	-------------	------------------	------

Patch cords

RJ 45 - RJ 45 - PVC

U/UTP cat. 5e unscreened impedance 100 Ω

Light pink

6327 30	Length 1 m	■	20
6327 31	Length 1.5 m	■	20
6327 32	Length 2 m	■	20
6327 33	Length 3 m	■	20
6327 34	Length 5 m	■	20

F/UTP cat. 5e screened impedance 100 Ω

Light brown

6327 40	Length 1 m	■	20
6327 41	Length 2 m	■	20
6327 42	Length 3 m	■	20
6327 43	Length 5 m	■	20

Legrand cabling system LCS³ doubler sockets, adaptors and accessories

RJ 45 doubler sockets

Mosaic - Ethernet/Ethernet

0765 39	FTP - 9 contacts	■	10
0765 38	UTP - 8 contacts	■	10

Mosaic - Telephone/Ethernet

0765 37	FTP - 9 contacts	■	10
0765 36	UTP - 8 contacts	■	10

Arteor - Telephone/Ethernet

5723 36	FTP - 9 contacts - White	■	10
5728 36	FTP - 9 contacts - Magnesium	■	10
5723 35	UTP - 8 contacts - White	■	10
5728 35	UTP - 8 contacts - Magnesium	■	10

Mosaic Telephone/telephone

0765 35	45 contacts	■	10
---------	-------------	---	----

Mobile doublers

Clip into RJ 45 sockets to double applications

0327 83	TV/computer network or telephone double connector	■	10
0327 47	Telephone/telephone doubler	■	10
0327 45	Computer network/ telephone doubler	■	10
0327 46	L1/L2 telephone doubler	■	10
0327 48	Computer network/ computer network double connector	■	10

Bold Cat.Nos are products normally available with Legrand (India) Stockists. Cat.Nos that are not bold - delivery within 4 - 8 weeks from the date of order. Bold packing quantity is our mandatory packing. Orders to be placed by Legrand (India) Stockist in multiples of the same.

Legrand cabling system LCS³ doubler sockets, adaptors and accessories

Cat.Nos	Description	MRP* ₹ / Unit	Pack
---------	-------------	------------------	------

Weatherproof adaptors

IP 55 - IK 07 - Allow all functions to be adapted
2 Mosaic modules IP 55 operation

Grey/White

0695 80	Adaptor with smoked flap	■	10
0695 79	Adaptor with smoked flap lockable by special tool	■	1
0695 81	Adaptor for RJ socket ensuring IP 44 waterproofness cable already connected	■	1
0919 45	Locking tool (used for changing vandal-proof screws)	■	1

Soliroc adaptor

Used for adapting all functions 2 Mosaic modules

IK 10 - IP 55

0778 80	Adaptor with flap	■	1
0778 81	Adaptor without flap	■	1

Hypra adaptor

0539 49	IP 55 adaptor base	■	5
---------	--------------------	---	---

Cable protection accessories

Plastic material
IP 66/67 guaranteed connection with the pair
Cat.No 0 533 02
IP 55 with no connection for base with blank
Protection for RJ 45 shielded or unshielded cables ensuring a link of category 5
Conform to standards of the IEC 60603-7 series and to standard IEC 61076-3-106 (version 5)
Compatible with products on the market conforming to the standards listed

Plug

0533 00	Integrated PE with sealing ring and clamping blades Tool-free assembly Ability to protect cables of category 5e	■	3
---------	--	---	---

Flush-mounting base

0533 01	Locking base Supplied with RJ 45 female/female coupler cat. 5e	■	3
---------	--	---	---

Kit

0533 02	Flush-mounting base + plug	■	3
---------	----------------------------	---	---

Protective flap

0533 03	Fits on base Cat.No 0 533 01	■	3
---------	---------------------------------	---	---

RJ plugs for round cables

Gold-coated contacts 1.2 µm

RJ 11

0517 01	4 contacts, width 9.65 mm	■	50
---------	---------------------------	---	----

RJ 12

0517 02	6 contacts, width 9.65 mm	■	50
---------	---------------------------	---	----

* MRP - Maximum Retail Price Inclusive of all taxes including GST.

■ Price available on request.

(1) in meters

Legrand cabling system LCS³ doubler sockets, adaptors and accessories

Cat.Nos	Description	MRP* ₹ / Unit	Pack
---------	-------------	------------------	------

RJ 45 cat. 5e

0517 03	8 contacts, width 11.70 mm	■	50
0517 04	9 contacts, width 11.70 mm	■	50

RJ 45 sleeves

0517 06	Black	■	50
0517 07	White	■	50

Stripping tool

Slits the sheath and releases the conductors by rotation
For twisted pair cables
Does not damage the conductors

Stripper

0332 62	For twisted pair and fibre optic cable	■	1
---------	--	---	---

Cutting pliers

0327 60	Cut wires cleanly without damaging the copper	■	1
---------	---	---	---

Crimping tool for RJ 45 plugs

Used for crimping plugs
RJ 4/6/8/9 contacts
Ratchet control of crimping mechanism Able to cut and strip cables

0517 09	Tool with 3 crimping points High resistance steel material	■	1
---------	---	---	---

110 tool

0332 60	110 tool	■	1
0332 61	Replacement blade	■	1

Legrand cabling system LCS³ data and telephone sockets, patch panels, cables

Telephone sockets

RJ 11 and RJ 12 sockets

Equipped with a modular Jack connector with 1/4 turn terminal for fast connection Tap-off possible

5723 00	White - RJ 11, 4 contacts 1 module	■	10
-	Aluminium - RJ 11, 4 contacts - 1 module	■	10
5728 00	Magnesium - RJ 11, 4 contacts - 1 module	■	10
5723 13	White - RJ 11, 4 contacts - 2 modules	■	10
5728 13	Magnesium - RJ 11, 4 contacts - 2 modules	■	10
5723 12	White - RJ 12, 6 contacts - 2 modules	■	10
5728 12	Magnesium - RJ 12, 6 contacts - 2 modules	■	10

ISDN socket

Self-stripping 1/4 turn terminals for fast connection. Tap-off possible

-	White - 8 contacts, 2.5 mm 2 earth terminal	■	10
---	--	---	----

Bold Cat.Nos are products normally available with Legrand (India) Stockists. Cat.Nos that are not bold - delivery within 4 - 8 weeks from the date of order. Bold packing quantity is our mandatory packing. Orders to be placed by Legrand (India) Stockist in multiples of the same.



0539 49



0533 00



0533 01



0327 60



0517 09

Legrand cabling system LCS³ data and telephone sockets, patch panels, cables

Cat.Nos	Description	MRP* ₹ / Unit	Pack
---------	-------------	------------------	------

Single master - 2 modules

With IDC connection
Conform to British Telecom

5723 10	White	■	10
5728 10	Magnesium	■	10

Single secondary - 1 module

With IDC connection
Conform to British Telecom

5723 01	White	■	5
5728 01	Magnesium	■	5

Patch panel telephone 50 ports 110 connect

0335 79

0335 79	19" panel - 1 U	■	1
---------	-----------------	---	---

Cables for telephone networks cat. 3

PVC sleeve
Colour white
Colour code TIA/EIA

U/UTP - 50 pairs

0328 91	Length 500 m Supplied on reel	■	1
---------	----------------------------------	---	---

U/UTP - 100 pairs

0328 88	Length 500 m Supplied on reel	■	1
---------	----------------------------------	---	---

Panels and units for incoming telephone

Panels assembled - 1 U

Fitted with 4 LCS³ RJ 45 units of 12 ports with fast tool-free connection

0335 31	3-6/4-5 contacts for digital telephone	■	1
0335 30	4-5/7-8 contacts for analogue telephone	■	1

Incoming telephone units for self-assembly panels

Fitted with 12 LCS³ RJ 45 ports with quick tool-free connection

0335 33	3-6/4-5 contacts for digital telephone	■	2
0335 32	4-5/7-8 contacts for analogue telephone	■	2

Audio/video system audio/video sockets

Female HD15 sockets

Used to transmit analogue video streams (VGA, XGA, UXGA depending on graphic card) between a source (computer) and a compatible receiver (video projector, TV, etc)

Arteor - Preterminated sockets - 1 module

Equipped with cord, length 15 cm

5720 97	White	■	1
5725 97	Magnesium	■	1

Arteor - Screw-type female HD15 sockets - 2 modules

5722 82	White	■	1
5727 82	Magnesium	■	1

* MRP - Maximum Retail Price Inclusive of all taxes including GST.
■ Price available on request.

Audio/video system audio/video sockets

Cat.Nos	Description	MRP* ₹ / Unit	Pack
---------	-------------	------------------	------

Arteor - Screw-type female HD15 sockets 2 modules + 3.5 mm Jack

5722 88	White	■	1
5727 88	Magnesium	■	1

Arteor - Solder-type female HD15 sockets 1 module

15 pin

5722 79	White	■	1
5727 79	Magnesium	■	1

HDMI type A sockets

Used to transmit high-definition digital audio/video streams between a source (computer, HD-DVD drive, etc) and a compatible receiver (TV, video projector, etc)

Arteor - Preterminated sockets HDMI 1.4 - 1 module

Equipped with cord, length 15 cm

5720 96	White	■	1
5725 96	Magnesium	■	1

Arteor - Screw-type sockets HDMI 1.3 - 2 modules

5722 81	White	■	1
5727 81	Magnesium	■	1

Jack sockets 3.5 mm

3.5 mm Jack connectors can be used to create audio/video links

Arteor - Preterminated sockets - 1 module

Equipped with cord, length 15 cm

5720 91	White	■	1
5725 91	Magnesium	■	1

Arteor - 4 screw-type female 3.5 mm Jack socket - 1 module

5722 74	White	■	1
5727 74	Magnesium	■	1

Arteor - Solder-type female 3.5 mm Jack socket - 1 module

5722 78	White	■	1
5727 78	Magnesium	■	1

Display port sockets

Used to transmit high-definition digital audio/video streams between a source (laptop, computer, etc) and a compatible receiver (video projector, TV, etc)

Arteor - Preterminated socket - 1 module

Equipped with cord, length 15 cm

5720 90	White	■	1
5725 90	Magnesium	■	1

Arteor - Female 2 RCA socket

Preterminated

Equipped with a 15 cm cord

5720 92	White	■	1
5725 92	Magnesium	■	1

Bold Cat.Nos are products normally available with Legrand (India) Stockists. Cat.Nos that are not bold - delivery within 4 - 8 weeks from the date of order. Bold packing quantity is our mandatory packing. Orders to be placed by Legrand (India) Stockist in multiples of the same.



5720 96



5720 97

Audio/video system

audio/video sockets



5722 72

Cat.Nos	Description	MRP* ₹ / Unit	Pack
---------	-------------	------------------	------

Connection via screw terminals

5722 72	White	■	1
5727 72	Magnesium	■	1

Arteor - Female 3 RCA socket

Preterminated

Equipped with a 15 cm cord

5720 93	White	■	1
5725 93	Magnesium	■	1

Connection via screw terminals

5722 73	White	■	1
5727 73	Magnesium	■	1



5727 73

Other audio and video sockets

Female BNC 75 socket - 1 module

5722 76	White	■	1
5727 76	Magnesium	■	1



5722 76

Arteor - Audio sockets

XLR 3-pin - 2 modules

5722 83	White - Fast screw connection female	■	1
5727 83	Magnesium - Fast screw connection female	■	1
5722 77	White - Fast screw connection male	■	1
5727 77	Magnesium - Fast screw connection male	■	1



5722 83

Loudspeakers sockets

Terminal 4 mm²

5722 80	White - 2 modules	■	10
5727 80	Magnesium - 2 modules	■	10
5722 70	White - 1 module	■	10
5727 70	Magnesium - 1 module	■	10



5727 70

100 V Line Volume Attenuators - 2 modules

Used to adjust power and volume of a 100 V loudspeaker line

5722 84	White - 100 V - 25 W	■	1
5727 84	Magnesium - 100 V - 25 W	■	1



5722 84

Audio/video system

audio/video patch panels, cords and cables

19" patch panels

0335 98	HD15 19" panel - 12 connectors	■	1
0335 96	HDMI 19" panel - 16 connectors	■	1
0335 97	XLR 19" panel - 16 connectors	■	1
0335 99	SUBD9 19" panel - 12 connectors	■	1



0335 98



0335 96



0335 97



0335 99

* MRP - Maximum Retail Price Inclusive of all taxes including GST.

■ Price available on request.

* To be introduced shortly.

Audio/video system

audio/video sockets

Cat.Nos	Description	MRP* ₹ / Unit	Pack
---------	-------------	------------------	------

Cords

For connecting a socket to a terminal

HD15 cord

0517 23	Length 10 m.	■	1
---------	--------------	---	---



0517 23

HD15 cord + 3.5 mm Jack

0517 22	Length 2 m	■	1
---------	------------	---	---

HDMI 1.4 cord

0517 26*	Length 1.5 m	■	1
0517 27*	Length 5 m	■	1
0517 20*	Length 10 m	■	1

HDMI booster

0779 30	Used to extend an HDMI connection.	■	1
---------	------------------------------------	---	---

XLR cord

0517 24	Length 10 m.	■	1
---------	--------------	---	---



0517 24

9-way SUB-D cord

0517 25	Length 10 m.	■	1
---------	--------------	---	---

Cables

VGA cables

0327 81	Length 20 m	■	1
---------	-------------	---	---

HDMI cables

0327 80	Length 20 m	■	1
---------	-------------	---	---

Legrand cabling system LCS³

fibre optic

Equipped 19" optic drawers

Sliding

0321 61	12 SC duplex multi-mode connectors for 24 fibres	■	1
0321 62	24 LC duplex multi-mode connectors for 48 fibres	■	1
0321 63	24 ST multi-mode connectors for 48 fibres	■	1
0321 64	12 SC duplex single-mode connectors for 24 fibres	■	1
0321 65	24 LC duplex single-mode connectors for 48 fibres	■	1
0321 66	12 SC APC duplex single-mode connectors for 24 fibres	■	1
0321 67	24 LC APC duplex single-mode connectors for 48 fibres	■	1



0321 62

Rotating

0321 71	36 LC duplex multi-mode connectors for 72 fibres	■	1
0321 72	18 SC duplex multi-mode connectors for 36 fibres	■	1
0321 73	36 LC duplex single-mode connectors for 72 fibres	■	1
0321 74	18 SC duplex single-mode connectors for 36 fibres	■	1



0321 72

Bold Cat.Nos are products normally available with Legrand (India) Stockists. Cat.Nos that are not bold - delivery within 4 - 8 weeks from the date of order. Bold packing quantity is our mandatory packing. Orders to be placed by Legrand (India) Stockist in multiples of the same.

Legrand cabling system LCS³ fibre optic

Cat.Nos	Description	MRP* ₹ / Unit	Pack
---------	-------------	------------------	------

19" modular optic drawers

Sliding, equipped

0321 02	12 SC duplex multi-mode connectors for 24 fibres	■	1
0321 04	24 LC duplex multi-mode connectors for 48 fibres	■	1
0321 06	12 SC duplex single-mode connectors for 24 fibres	■	1

Sliding, to be equipped with fibre optic blocks

It can accept all fibre optic blocks; 4 blocks maximum



0321 00

0321 00	Empty drawer	■	1
---------	--------------	---	---

Fibre optic blocks

Singlemode fibre optic blocks (9/125 µm)

0321 17	ST block for 6 single-mode fibre optics	■	1
0321 10	SC duplex block for 6 single-mode fibre optics	■	1
0321 11	SC duplex high density block for 12 single-mode fibre optics	■	1
0321 12	SC APC duplex block for 6 single-mode fibre optics	■	1
0321 13	LC duplex block for 6 single-mode fibre optics	■	1
0321 14	LC duplex block for 12 single-mode fibre optics	■	1
0321 15	LC duplex high density block for 24 single-mode fibre optics	■	1
0321 16	LC APC duplex block for 12 single-mode fibre optics	■	1
0321 33	Single-mode 4 MTP ¹ feedthrough adapter	■	1



0321 15



0321 33

Multimode fibre optic blocks (62.5 and 50/125 µm)

0321 27	ST block for 6 multimode fibre optics	■	1
0321 20	SC duplex block for 6 multimode fibre optics	■	1
0321 21	SC duplex high density block for 12 multimode fibre optics	■	1
0321 23	LC duplex block for 6 multimode fibre optics	■	1
0321 24	LC duplex block for 12 multimode fibre optics	■	1
0321 25	LC duplex high density block for 24 multimode fibre optics	■	1
0321 34	Multimode 4 MTP ¹ feedthrough adapter	■	1



0321 21

Copper block for fibre optic drawer

0321 32	"It clips directly to the optic drawer to be equipped, Cat.No 0321 00 It gives the possibility of mixing fibre optic and copper"	■	1
---------	--	---	---

Accessories for optic drawer to be equipped

Accessory for receipt of a fan-out

0321 28	It's clipped at the back of the drawer It enables the entry of preterminated Cat.Nos	■	1
---------	---	---	---

* MRP - Maximum Retail Price Inclusive of all taxes including GST.

■ Price available on request.

1: MTP is a registered trademark of US Conec Ltd

Legrand cabling system LCS³ fibre optic

Cat.Nos	Description	MRP* ₹ / Unit	Pack
---------	-------------	------------------	------

Blank

0321 29	Blank block	■	1
---------	-------------	---	---

Pigtail cassette

0321 30	Capacity 24 fibre optics	■	1
---------	--------------------------	---	---

Coiling kit

0321 31	1 accessory	■	1
---------	-------------	---	---



0321 40

Modular 19" panel to be equipped with cassettes

0321 40	Depth 190 mm, height 1 U	■	1
---------	--------------------------	---	---

Optic drawer cassettes

Fibre optic splice cassette

0321 41	It can accept all modular fibre optic blocks	■	1
---------	--	---	---



0321 41

Copper cassette to be equipped

0337 55	It can accept 6 cat. 5e, cat. 6 and cat. 6 _A connectors	■	1
---------	--	---	---

MTP¹ preterminated cassette (MPO compatible)

Front and rear extraction

High performance cassette, low insertion loss

<0.35 dB

0321 42	Multimode OM4 cassette (50/125 µm) 24 filaments LC OM4 Type A/C	■	1
0321 43	Multimode OM4 cassette (50/125 µm) 12 SC OM4 Type A/C	■	1
0321 44	Single-mode OS2 cassette (9/125 µm) type OS2 24 LC OS2 Type A/C	■	1
0321 45	Single-mode OS2 cassette (9/125 µm) 12 SC OS2 Type A/C	■	1

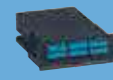

0321 43

Blanking cassette

0337 57	Used to blank the panel	■	1
---------	-------------------------	---	---

Adapters

0321 33	Single-mode 4 MTP ¹ adapter (installation in cassette 0 321 41)	■	1
0321 34	Multi-mode 4 MTP ¹ adapter (installation in cassette 0 321 41)	■	1

Accessories for 19" panel to be equipped with cassettes



0321 46

0321 46	Rear cable management accessory For installation on panels Cat.No 0 321 40	■	1
0321 47	Cord management kit (guide/support/door)	■	1

Bold Cat.Nos are products normally available with Legrand (India) Stockists. Cat.Nos that are not bold - delivery within 4 - 8 weeks from the date of order. Bold packing quantity is our mandatory packing. Orders to be placed by Legrand (India) Stockist in multiples of the same.

Legrand cabling system LCS³ fibre optic

Cat.Nos	Description	MRP* ₹ / Unit	Pack
---------	-------------	------------------	------

Pigtails

50/125 µm - OM2 (PC)

Connectors

0322 10	SC 1 m LSZH	■	10
0322 11	LC 1 m LSZH	■	10
0322 12	ST 1 m LSZH	■	10
0322 13	SC 2 m LSZH	■	10
0322 14	LC 2 m LSZH	■	10
0322 15	ST 2 m LSZH	■	10

50/125 µm - OM3 (PC)

Connectors

0322 20	SC 1 m LSZH	■	10
0322 21	LC 1 m LSZH	■	10
0322 22	ST 1 m LSZH	■	10
0322 23	SC 2 m LSZH	■	10
0322 24	LC 2 m LSZH	■	10

50/125 µm - OM4 (PC)

Connectors

0322 30	SC 1 m LSZH	■	10
0322 31	LC 1 m LSZH	■	10
0322 32	ST 1 m LSZH	■	10
0322 33	SC 2 m LSZH	■	10
0322 34	LC 2 m LSZH	■	10

9/125 µm - OS2 (APC or UPC) - OS1 compatible

Connectors

0322 40	SC-APC OS2 1 m LSZH	■	10
0322 41	SC-UPC OS2 1 m LSZH	■	10
0322 42	LC-APC OS2 1 m LSZH	■	10
0322 43	LC-UPC OS2 1 m LSZH	■	10
0322 44	ST-UPC OS2 1 m LSZH	■	10
0322 45	SC-APC OS2 2 m LSZH	■	10
0322 46	SC-UPC OS2 2 m LSZH	■	10
0322 47	LC-UPC OS2 2 m LSZH	■	10
0322 48	LC-APC OS2 2 m LSZH	■	10
0322 49	ST-UPC OS2 2 m LSZH	■	10

Set of 12 LC pigtails

0326 24	OS2 12 pigtails LC-UPC	■	1
0326 26	OM3 12 pigtails LC-PC	■	1
0326 71	OM4 12 pigtails LC-PC	■	1

Pigtail sleeves

0327 44	40 mm - bag of 50 sheaths	■	1
---------	---------------------------	---	---

Glue-on connectors 50/125 and 62.5/125 µm

0331 27	ST	■	10
0331 47	SC	■	10
0331 00	LC	■	10

* MRP - Maximum Retail Price Inclusive of all taxes including GST.

■ Price available on request.

1: MTP is a registered trademark of US Conec Ltd



0322 20

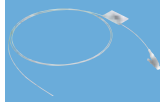

0322 31



0322 70



0322 72



0322 73



0322 75



0322 83

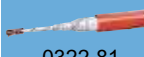

0322 81

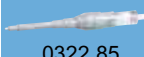

0322 85



0321 50

Legrand cabling system LCS³ fibre optic

Cat.Nos	Description	MRP* ₹ / Unit	Pack
---------	-------------	------------------	------

Fan-out units

0330 48	6 fibre optic fan-out unit	■	1
0330 49	12 fibre optic fan-out unit	■	1

Tool case for the preparation of the fibre optic for quick-connect connectors

0322 70	It contains the tools required for the preparation of the fibre optic cable, for the completion of a first test to confirm the correct connection of the fibre optic to the connector, and the accessories for easy connection in all situations	■	1
---------	--	---	---

Quick-connect connectors

OM3/OM4 multimode connectors

Set of 12 connectors

0322 71	LC PC 50/125 µm, 900/250 µm	■	1
0322 72	SC PC 50/125 µm, 900/250 µm	■	1

OS2 single-mode connectors

Set of 12 connectors

0322 73	LC UPC 9/125 µm, 900/250 µm	■	1
0322 74	SC UPC 9/125 µm, 900/250 µm	■	1
0322 75	SC APC 9/125 µm, 900/250 µm	■	1

Precision cleaver for the update of the case kit Cat.No 0326 90

0322 80	It's used in conjunction with the kit of the case Cat.No 0 326 90, to cut the fibre optic with precision, and fit the quick-connect connectors, Cat.No 0 322 71 to 0 322 75	■	1
---------	---	---	---

Fibre optic cleaning accessories

0322 83	Ferrule cleaner MPO/MTP1	■	1
0322 81	Ferrule cleaner LC (PC/APC)	■	1
0322 82	Ferrule cleaner SC (PC/APC)	■	1
0322 84	LC replacement cartridge	■	1
0322 85	LC replacement cartridge	■	1

Fibre optic drawers with front facing cord management

0321 50	1 U	■	1
0321 52	2 U	■	1
0321 53	4 U	■	1
0321 51	UHD Panel to be equipped cassette without rear management 1 U	■	1

Bold Cat.Nos are products normally available with Legrand (India) Stockists. Cat.Nos that are not bold - delivery within 4 - 8 weeks from the date of order. Bold packing quantity is our mandatory packing. Orders to be placed by Legrand (India) Stockist in multiples of the same.

Legrand cabling system LCS³ fibre optic

Cat.Nos	Description	MRP* ₹ / Unit	Pack
---------	-------------	------------------	------

Very high density cassettes

Multimode OM4 cassette (50/125 µm)

For OM4 type 50/125 µm multimode installations

0321 54	MPO cassette 12 LC OM4 Type A/C	■	
---------	---------------------------------	---	--

OS2 cassette (9/125 µm)

For OS2 type 9/125 µm multimode installations

0321 55	MPO cassette 12 LC OS2 Type A/C	■	
---------	---------------------------------	---	--

MTP¹ adapters (MPO compatible)

They are clipped directly to the fibre optic drawers, Cat.Nos 0 321 50/51/52/53

0321 56	Multimode 4 MTP1 adapter	■	
0321 57	Single-mode 4 MTP1 adapter	■	

LC adapter

It's clipped directly to the fibre optic drawers, Cat.Nos 0 321 50/51/52/53

0321 58	Adapter 12 LC multimode	■	1
---------	-------------------------	---	---

Modular 19" panel to be equipped with cassettes

0321 40	Depth 190 mm, height 1 U	■	1
---------	--------------------------	---	---

High density MTP1 cassette (MPO compatible)

Fibre optic splice cassette

0321 41	It can accept all modular fibre optic blocks	■	1
---------	--	---	---

Copper cassette to be equipped

0337 55	It can accept 6 cat. 5e, cat. 6 and cat. 6A connectors	■	1
---------	--	---	---

Multimode OM4 cassettes (50/125 µm)

0321 42	MTP ¹ cassette (MPO compatible) 24 LC OM4 Type A/C	■	1
0321 43	MTP ¹ cassette (MPO compatible) 12 SC OM4 Type A/C	■	1

Single-mode OS2 cassettes (9/125 µm)

OS2 type

0321 44	MTP ¹ cassette (MPO compatible) 24 LC OS2 Type A/C	■	1
0321 45	MTP ¹ cassette (MPO compatible) 12 SC OS2 Type A/C	■	1

Blanking cassette

0337 57	Used to blank the panel	■	1
---------	-------------------------	---	---

MTP¹ adapters

It's installed in splice cassettes, Cat.No 0 321 41
It enables MTP¹/MTP¹ feedthrough

0321 33	Single-mode 4 MTP ¹ adapter	■	1
0321 34	Multimode 4 MTP ¹ adapter	■	1

* MRP - Maximum Retail Price Inclusive of all taxes including GST.

■ Price available on request.

1: MTP is a registered trademark of US Conec Ltd

Legrand cabling system LCS³ fibre optic preterminated solution

Cat.Nos	Description	MRP* ₹ / Unit	Pack
---------	-------------	------------------	------

Accessories for 19" panel to be equipped with cassette

Rear cable management accessory

0321 46	For installation on panels Cat.No 0 321 40	■	1
---------	--	---	---

Cord management kit (guide/support/door)

0321 47	For installation on panel Cat.No 0 321 40; 2 side cord	■	1
---------	--	---	---

Legrand cabling system LCS³ fibre optic preterminated solution

High density preterminated fibre optic links

Micro cables OM3 Fan-out - Fan-out

Micro cables with spark gap, output 2 mm

0324 01	6 LC Duplex - 6 LC Duplex Length 10	■	1
0324 02	6 LC Duplex - 6 LC Duplex Length 20 (m)	■	1
0324 03	6 LC Duplex - 6 LC Duplex Length 30 (m)	■	1
0324 04	6 LC Duplex - 6 LC Duplex Length 40 (m)	■	1
0324 05	6 LC Duplex - 6 LC Duplex Length 50 (m)	■	1
0324 11	12 LC Duplex - 12 LC Duplex Length 10 (m)	■	1
0324 12	12 LC Duplex - 12 LC Duplex Length 20 (m)	■	1
0324 13	12 LC Duplex - 12 LC Duplex Length 30 (m)	■	1
0324 14	12 LC Duplex - 12 LC Duplex Length 40 (m)	■	1
0324 15	12 LC Duplex - 12 LC Duplex Length 50 (m)	■	1

Micro cables OS2 Fan-out - Fan-out

Micro cables with spark gap, output 2 mm

0324 21	6 LC Duplex - 6 LC Duplex Length 10 (m)	■	1
0324 22	6 LC Duplex - 6 LC Duplex Length 20 (m)	■	1
0324 23	6 LC Duplex - 6 LC Duplex Length 30 (m)	■	1
0324 24	6 LC Duplex - 6 LC Duplex Length 40 (m)	■	1
0324 25	6 LC Duplex - 6 LC Duplex Length 50 (m)	■	1
0324 31	12 LC Duplex - 12 LC Duplex Length 10 (m)	■	1
0324 32	12 LC Duplex - 12 LC Duplex Length 20 (m)	■	1
0324 33	12 LC Duplex - 12 LC Duplex Length 30 (m)	■	1
0324 34	12 LC Duplex - 12 LC Duplex Length 40 (m)	■	1
0324 35	12 LC Duplex - 12 LC Duplex Length 50 (m)	■	1

Bold Cat.Nos are products normally available with Legrand (India) Stockists. Cat.Nos that are not bold - delivery within 4 - 8 weeks from the date of order. Bold packing quantity is our mandatory packing. Orders to be placed by Legrand (India) Stockist in multiples of the same.

Legrand cabling system LCS³

cables

Cat.Nos	Description	MRP* ₹ / Unit	Pack
---------	-------------	------------------	------

Micro cables OM3 MTP1

0324 41	12 fibre optics - MTP1- MTP1 Length 10 (m)	■	1
0324 42	12 fibre optics - MTP1- MTP1 Length 20 (m)	■	1
0324 43	12 fibre optics - MTP1- MTP1 Length 30 (m)	■	1
0324 44	12 fibre optics - MTP1- MTP1 Length 40 (m)	■	1
0324 45	12 fibre optics - MTP1- MTP1 Length 50 (m)	■	1

Micro cables OS2 MTP1

0324 51	12 fibre optics - MTP1- MTP1 Length 10 (m)	■	1
0324 52	12 fibre optics - MTP1- MTP1 Length 20 (m)	■	1
0324 53	12 fibre optics - MTP1- MTP1 Length 30 (m)	■	1
0324 54	12 fibre optics - MTP1- MTP1 Length 40 (m)	■	1
0324 55	12 fibre optics - MTP1- MTP1 Length 50 (m)	■	1

OM 4 multimode fibre optic cables (50/125 µm)

"Bend insensitive"

For multimode installations 50/125 µm, type OM 4

Aqua sheaths

Suitable for 10 Giga Ethernet networks

Loose tube

0325 43	Indoor/outdoor (glass strands) 4 fibres - 2000 m	■	2000
0325 44	Indoor/outdoor (glass strands) 8 fibres - 2000 m	■	2000
0325 45	Indoor/outdoor (glass strands) 12 fibres - 2000 m	■	2000
0325 46	Outdoor, corrugated steel tape 4 fibres - 2000 m	■	2000
0325 47	Outdoor, corrugated steel tape 8 fibres - 2000 m	■	2000
0325 48	Outdoor, corrugated steel tape 12 fibres - 2000 m	■	2000

Tight structure 900 µm

0326 65	Indoor/outdoor (glass strands) 6 fibres - 500 m	■	2000
0326 66	Indoor/outdoor (glass strands) 6 fibres - 1000 m	■	2000
0326 67	Indoor/outdoor (glass strands) 12 fibres - 1000 m	■	2000
0326 68	Indoor/outdoor (glass strands) 24 fibres - 1000 m	■	2000

OS 2 single-mode fibre optic cables (9/125 µm) - (OS1 compatible)

For single-mode installations 9/125 µm, type OS 2

Yellow or black sheaths for outdoor, rodent guard...

Loose tube

0325 02	Indoor/outdoor (glass strands) 4 fibres	■	2000
---------	---	---	------

* MRP - Maximum Retail Price Inclusive of all taxes including GST.

■ Price available on request.

1: MTP is a registered trademark of US Conec Ltd

Legrand cabling system LCS³

cables

Cat.Nos	Description	MRP* ₹ / Unit	Pack
---------	-------------	------------------	------

Loose tube

0325 03	Indoor/outdoor (glass strands) 8 fibres	■	2000
0325 23	Outdoor, corrugated steel tape 4 fibres	■	2000
0325 24	Outdoor, corrugated steel tape 8 fibres	■	2000
0325 25	Outdoor, corrugated steel tape 24 fibres	■	2000
0325 12	Indoor/outdoor (glass strands) 6 fibres	■	2000
0325 13	Outdoor, corrugated steel tape 6 fibres	■	2000
0325 14	Indoor/outdoor (glass strands) 12 fibres	■	2000
0325 15	Outdoor, corrugated steel tape 12 fibres	■	2000
0325 51	Indoor/outdoor (glass strands) 24 fibres	■	2000

Tight structure 900 µm

0325 50	Indoor/outdoor (glass strands) 12 fibres	■	2000
---------	--	---	------

OM 3 multimode fibre optic cables (50/125 µm)

"Bend insensitive"

For multimode installations 50/125 µm, type OM 3

Aqua sheaths

Suitable for 10 Giga Ethernet networks

Loose tube

0325 53	Indoor/outdoor (glass strands) 24 fibres	■	2000
0325 37	Indoor/outdoor (glass strands) 4 fibres	■	2000
0325 38	Indoor/outdoor (glass strands) 8 fibres	■	2000
0325 39	Indoor/outdoor (glass strands) 12 fibres	■	2000
0325 40	Outdoor, corrugated steel tape 8 fibres	■	2000
0325 41	Outdoor, corrugated steel tape 12 fibres	■	2000
0325 42	Outdoor, corrugated steel tape 24 fibres	■	2000

Tight structure 900 µm

0325 10	Indoor/outdoor (glass strands) 6 fibres	■	2000
0325 11	Indoor/outdoor (glass strands) 12 fibres	■	2000
0325 52	Indoor/outdoor (glass strands) 24 fibres	■	2000

OM 2 multimode fibre optic cables (50/125 µm)

For 50/125 µm multimode installations (OM 2)

Orange jacket or black for outdoor, corrugated

Loose tube

0325 04	Indoor/outdoor (universal) 6 fibres	■	2000
0325 05	Outdoor, corrugated steel tape 6 fibres	■	2000
0325 06	Indoor/outdoor (universal) 12 fibres	■	2000
0325 07	Outdoor, corrugated steel tape 12 fibres	■	2000

Bold Cat.Nos are products normally available with Legrand (India) Stockists. Cat.Nos that are not bold - delivery within 4 - 8 weeks from the date of order. Bold packing quantity is our mandatory packing. Orders to be placed by Legrand (India) Stockist in multiples of the same.

Legrand cabling system LCS³ fibre optic

Cat.Nos	Description	MRP* ₹ / Unit	Pack
900 µm Tight buffer			
0325 55	Indoor/outdoor (universal) 4 fibres	■	2000
0325 08	Indoor/outdoor (universal) 6 fibres	■	2000
0325 09	Indoor/outdoor (universal) 12 fibres	■	2000

0325 08

Legrand cabling system LCS³ patch cords

OS 1/OS 2 (UPC) single-mode optical cords

SC/SC duplex cords

0326 00	Length: 1 m	■	3
0326 01	Length: 2 m	■	3
0326 02	Length: 3 m	■	3

SC/LC duplex cords

0326 03	Length: 1 m	■	3
0326 04	Length: 2 m	■	3
0326 05	Length: 3 m	■	3

LC/LC duplex cords

0326 28	Length: 0.5 m	■	3
0326 06	Length: 1 m	■	3
0326 07	Length: 2 m	■	3
0326 08	Length: 3 m	■	3
0326 29	Length: 5 m	■	3

0326 07

LC/LC Uniboot duplex cords

Reversible polarity

0326 86	Length: 1 m	■	3
0326 87	Length: 2 m	■	3
0326 88	Length: 3 m	■	3
0326 89	Length: 5 m	■	3
0326 92	Length: 10 m	■	3

OM 4 multimode fibre optic cords (50/125 µm)

SC/SC duplex cords

0326 30	Length: 1 m	■	3
0326 31	Length: 2 m	■	3
0326 32	Length: 3 m	■	3

LC/LC duplex cords

0326 33	Length: 0.5 m	■	3
0326 34	Length: 1 m	■	3
0326 35	Length: 2 m	■	3
0326 36	Length: 3 m	■	3
0326 37	Length: 5 m	■	3

LC/LC Uniboot duplex cords

Reversible polarity

0326 95	Length: 1 m	■	3
0326 96	Length: 2 m	■	3
0326 97	Length: 3 m	■	3
0326 98	Length: 5 m	■	3
0326 99	Length: 10 m	■	3

* MRP - Maximum Retail Price Inclusive of all taxes including GST.

■ Price available on request.

1: MTP is a registered trademark of US Conec Ltd

Legrand cabling system LCS³ fibre optic preterminated solution

Cat.Nos	Description	MRP* ₹ / Unit	Pack
OM 3 multimode fibre optic cords (50/125 µm)			
SC/SC duplex cords			
0326 09	Length: 1 m	■	3
0326 10	Length: 2 m	■	3
0326 11	Length: 3 m	■	3



0326 13

SC/LC duplex cords

0326 12	Length: 1 m	■	3
0326 13	Length: 2 m	■	3
0326 14	Length: 3 m	■	3

LC/LC duplex cords

0326 15	Length: 1 m	■	3
0326 16	Length: 2 m	■	3
0326 17	Length: 3 m	■	3

OM 2 multimode fibre optic cords (50/125 µm)

ST/ST duplex cords

0330 80	Length: 1 m	■	3
0330 81	Length: 2 m	■	3
0330 82	Length: 3 m	■	3

SC/SC duplex cords

0330 69	Length: 1 m	■	3
0330 70	Length: 2 m	■	3
0330 71	Length: 3 m	■	3

ST/SC duplex cords

0330 72	Length: 2 m	■	3
0330 73	Length: 3 m	■	3

LC/LC duplex cords

0330 61	Length: 2 m	■	3
---------	-------------	---	---

SC/LC duplex cords

0330 75	Length: 1 m	■	3
0330 63	Length: 2 m	■	3
0330 76	Length: 3 m	■	3

LC/ST duplex cords

0330 65	Length: 2 m	■	3
---------	-------------	---	---

Fibre optic feedthrough sockets

2 x ST fibre optic feedthrough socket

Bayonet mount (STII compatible)

0786 16	White	■	1
---------	-------	---	---

2 x SC fibre optic feedthrough socket

"Push-pull" connection

0786 17	White	■	1
---------	-------	---	---

2 x LC fibre optic feedthrough socket

"Push-pull" connection

0786 18	White	■	1
---------	-------	---	---

Bold Cat.Nos are products normally available with Legrand (India) Stockists. Cat.Nos that are not bold - delivery within 4 - 8 weeks from the date of order. Bold packing quantity is our mandatory packing. Orders to be placed by Legrand (India) Stockist in multiples of the same.

Lighting management solution

Putting a stop to energy waste

Sensors



PIR 180° Sensor



PIR 360° Sensor



Ultrasonic 360° Sensor



Dual Technology 360° Sensor



Sustainable development



Energy saving



Code compliance



Economic saving



Sustainable building practice

Lighting control strategies



Vacancy - based control



Occupancy - based control



Dimming control



Scheduled control



Daylight control



for more details, ask for a copy of Lighting Management Solution catalogues

Movement detectors

Cat.Nos	Description	MRP* ₹ / Unit	Pack
---------	-------------	------------------	------

Movement detectors for lighting control

IP 20-IP 55 direction movement detector with 180- 360° detection angle. For 2000 Watt "incandescent, 230 V halogen," 1000 VA fluroscet

0489 43	PIR motion detector sensor	3482	1/10
0488 99	PIR ceiling dectector sensor	4354	1/10
0488 06	Dual ceiling switch sensor 8.5A	9026	1/10
0488 07	PIR ceiling switch sensor 10A	9100	1/10
0488 17	PIR switch sensor corridor	9828	1/10
0488 04	PIR switch sensor 2 outputs	10388	1/10
0489 17	PIR wall sensor 180d	14876	1/10
0489 16	DT WALL. OCC SW.SENS.	17322	1/10
0489 33	PIR WALL SWI. SENS. 270 degree	19192	1/10

NEW!



0489 16

Video door entry systems

Colour image digital video door entry system kit

3695 80	Basic video kit 7" hands free	13006	1
3695 70	Basic video kit 7" handset	13864	1
3695 60	Basic video kit 4.3" hands free	12032	1
3695 50	Basic video kit 4.3" handset	12370	1
3695 00	Basic audio kit handset	6270	1
3695 85	Basic video additional IU 7" hands free	7684	1
3695 75	Basic video additional IU 7" handset	8206	1
3695 65	Basic video additional IU 4.3" hands free	6644	1
3695 55	Basic video additional IU 4.3" handset	7232	1
3695 05	Basic audio additional handset	3320	1
3695 96	Basic additional video EP	5478	1
3695 95	Basic additional audio EP	3024	1
3695 97	Basic EP angle bracket	674	1



3695 80



3695 70



3695 60



3695 50



3695 00

Movement Detectors

For lighting control

180° detection range



bticino

D45 SYSTEM

High performance simplified

The D45 system simplifies installation in residential spaces right from a single house to a group of houses to residential complexes with a large number of apartments.



Slim 7" wide screen with alarm function



10" Touch screen internal unit



Audio handset



Entrance panels

* MRP - Maximum Retail Price Inclusive of all taxes including GST.
Red Cat.Nos - new products

Bold Cat.Nos are products normally available with Legrand (India) Stockists. Cat.Nos that are not bold - delivery within 4 - 8 weeks from the date of order. Bold packing quantity is our mandatory packing. Orders to be placed by Legrand (India) Stockist in multiples of the same.

THE NEW CLASSE 300

Lets people open their door from anywhere.

STAY CONNECTED WITH THE CLASSE 300:

Open your front door with an app on your phone from your sofa, your shower, from your gym, from the island where you are vacationing, from anyplace with an internet connection!



THE NEW CLASSE 300

IT'S A CLASSE APART

- Call your home directly
- Open the gate to your property from anywhere
- Switch on lights in your home and sprinklers in your garden
- See what is happening inside your home
- Listen to messages left by visitors to your home

P17 Tempra Pro and Hypra Plugs and Sockets

For safe connection which you can depend on.
Ensures the protection of personnel at electrical installation

**P17 Tempra Pro
plugs and
sockets**



**Hypra prisinter
and Hypra plugs
and sockets**



**P17 Tempra
combined
units**



**Metra
metallic
plugs and
sockets**



**Metallic
plug and
socket DB's**



P17 Tempra Pro IP 44 - LV 16 and 32 A - sockets and plugs

Cat.Nos	Description	MRP* ₹ / Unit	Pack
---------	-------------	------------------	------

Surface mounting sockets

5551 54	200/250 V~, 16 A 2P+E	602	10
5551 58	380/415 V~, 16 A 3P+E	758	10
5551 59	380/415 V~, 16 A 3P+N+E	758	10
5552 54	200/250 V~, 32 A 2P+E	754	5
5552 58	380/415 V~, 32 A 3P+E	960	10
5552 59	380/415 V~, 32 A 3P+N+E	960	10

Panel mounting sockets inclined outlet

5551 84	200/250 V~, 16 A 2P+E	360	10
5551 88	380/415 V~, 16 A 3P+E	560	10
5551 89	380/415 V~, 16 A 3P+N+E	558	10
5552 84	200/250 V~, 32 A 2P+E	584	10
5552 88	380/415 V~, 32 A 3P+E	742	10
5552 89	380/415 V~, 32 A 3P+N+E	742	10

Mobile sockets

5551 04	200/250 V~, 16 A 2P+E	468	10
5551 08	380/415 V~, 16 A 3P+E	552	10
5551 09	380/415 V~, 16 A 3P+N+E	552	10
5552 14	200/250 V~, 32 A 2P+E	626	10
5552 18	380/415 V~, 32 A 3P+E	790	10
5552 19	380/415 V~, 32 A 3P+N+E	788	10

Straight plugs

5551 24	200/250 V~, 16 A 2P+E	332	10
5551 28	380/415 V~, 16 A 3P+E	430	10
5551 29	380/415 V~, 16 A 3P+N+E	430	10
5552 34	200/250 V~, 32 A 2P+E	520	10
5552 38	380/415 V~, 32 A 3P+E	606	10
5552 39	380/415 V~, 32 A 3P+N+E	606	10

P17 Tempra - domestic pin configuration 16 A - 250 V~

Flush-mounting boxes

0577 21	For 2 panel mounting sockets With single fixing centres 70 x 70 mm - 16 A	3476	3
0577 22	For 1 panel mounting socket With single fixing centres 70 x 70 mm - 16 or 32 A (32 A to be fixed horizontally)	2084	3

* MRP - Maximum Retail Price Inclusive of all taxes including GST.

P17 Tempra Pro IP 66/67 LV 16 and 32 A

Cat.Nos	Polarity	MRP* ₹ / Unit	Pack
---------	----------	------------------	------

Surface mounting sockets

5553 54	200/250 V~, 16 A 2P+E	978	5
5553 58	380/415 V~, 16 A 3P+E	1144	5
5553 59	380/415 V~, 16 A 3P+N+E	1242	5
5554 54	200/250 V~, 32 A 2P+E	1106	5
5554 55	200/250 V~, 32 A 3P+E	2102	5
5554 59	380/415 V~, 32 A 3P+N+E	2280	5

Panel mounting sockets

5553 84	200/250 V~, 16 A 2P+E	714	5
5553 88	380/415 V~, 16 A 3P+E	800	5
5553 89	380/415 V~, 16 A 3P+N+E	800	5
5554 84	200/250 V~, 32 A 2P+E	910	5
5554 88	380/415 V~, 32 A 3P+E	1094	5
5554 89	380/415 V~, 32 A 3P+N+E	1094	5

Mobile sockets

5553 04	200/250 V~, 16 A 2P+E	876	5
5553 08	380/415 V~, 16 A 3P+E	1144	5
5553 09	380/415 V~, 16 A 3P+N+E	1144	5
5554 14	200/250 V~, 32 A 2P+E	1202	5
5554 18	380/415 V~, 32 A 3P+E	1348	5
5554 19	380/415 V~, 32 A 3P+N+E	1352	5

Straight plugs

5553 24	200/250 V~, 16 A 2P+E	762	5
5553 28	380/415 V~, 16 A 3P+E	876	5
5553 29	380/415 V~, 16 A 3P+N+E	880	5
5554 34	200/250 V~, 32 A 2P+E	1082	5
5554 38	380/415 V~, 32 A 3P+E	1138	5
5554 39	380/415 V~, 32 A 3P+N+E	1138	5

P17 Tempra Pro IP 66/67 LV 32 A for refrigerated containers

Combined unit, plug and mobile socket for refrigerated containers

6571 06	Combined unit with interlocked switched socket - Double mechanical interlock - Cable glands are not supplied	16072	1
---------	--	-------	---

Bold Cat.Nos are products normally available with Legrand (India) Stockists. Cat.Nos that are not bold - delivery within 4 - 8 weeks from the date of order. Bold packing quantity is our mandatory packing. Orders to be placed by Legrand (India) Stockist in multiples of the same.



5552 58



5551 88



5551 08



5551 28



5553 28



0577 22



6571 06

P17 Tempra Pro IP 66/67 LV 32 A for refrigerated containers

Cat.Nos	Polarity	MRP* ₹ / Unit	Pack
---------	----------	------------------	------

Combined unit, plug and mobile socket for refrigerated containers

5554 91	Panel mounting socket	1328	5
5554 21	Mobile socket with cable grip Ø12 to 21.5 mm	1610	5
5554 41	Straight plug With cable grip Ø12 to 21.5 mm	1294	5

P17 Tempra Pro IP 66/67 - LV 63 and 125 A

NEW!

Surface mounting sockets

5555 54	200/250 V~, 63 A 2P+E	4248	2
5555 58	380/415 V~, 63 A 3P+E	4228	2
5555 59	380/415 V~, 63 A 3P+N+E	4228	2
5556 58	380/415 V~, 125 A 3P+E	12306	2
5556 59	380/415 V~, 125 A 3P+N+E	12306	2

Panel mounting sockets

5555 84	200/250 V~, 63 A 2P+E	3368	2
5555 88	380/415 V~, 63 A 3P+E	3436	2
5555 89	380/415 V~, 63 A 3P+N+E	3232	2
5556 88	380/415 V~, 125 A 3P+E	9726	1
5556 89	380/415 V~, 125 A 3P+N+E	9628	1

Straight plugs

5555 24	200/250 V~, 63 A 2P+E	2854	2
5555 28	380/415 V~, 63 A 3P+E	2898	2
5555 29	380/415 V~, 63 A 3P+N+E	2996	2
5556 28	380/415 V~, 125 A 3P+E	8628	1
5556 29	380/415 V~, 125 A 3P+N+E	8628	1

Mobile sockets

5555 04	200/250 V~, 63 A 2P+E	3640	2
5555 08	380/415 V~, 63 A 3P+E	3602	2
5555 09	380/415 V~, 63 A 3P+N+E	3824	2
5556 08	380/415 V~, 125 A 3P+E	12558	1
5556 09	380/415 V~, 125 A 3P+N+E	12558	1

* MRP - Maximum Retail Price Inclusive of all taxes including GST.
Red Cat.Nos - new products

Plugs and sockets

Cat.Nos	Polarity	MRP* ₹ / Unit	Pack
---------	----------	------------------	------

P17 combined unit to be equipped

Bases with mechanical super-compact sockets

0573 00	16 A, 2P+E IP 44 Interlock	4248	1
0573 02	16 A, 3P+N+E IP 44 Interlock	4688	1
0573 20	16 A, 2P+E IP 55 Interlock	4768	1
0573 22	16 A, 3P+N+E IP 55 Interlock	5364	1
0577 23	Mounting plate for 2 super-compact mechanical interlock sockets	2384	1

Bases for 125 x 220 mm face plates

0577 10	Surface mounting box - upto 2 sockets	938	2
0589 38	Surface mounting box with 5 module dinrail - upto 2 sockets	2646	1
0577 05	Surface mounting box with 12 module dinrail - upto 4 sockets	5786	1
0577 06	Surface mounting box with 18 module dinrail - upto 6 sockets	8100	1

Face plates 125 x 220 mm without sockets

0577 12	For 1 x 16 A or 32 A - upto A socket	898	5
0577 13	For 2 x 16 A - upto sockets	1184	5
0577 17	For 1 x 63 A - upto sockets	1086	5
0577 15	Blanking Plate	800	5

Bases for 125 x 280 mm faceplates

0577 11	Surface mounting box - upto 3 sockets	976	3
0577 20	Surface mounting box with 5 module dinrail - upto 3 sockets	2978	1
0577 03	Surface mounting box with 12 module dinrail - upto 6 sockets	6000	1
0577 04	Surface mounting box with 18 module dinrail - upto 9 sockets	8346	1

Face plates 125 x 280 mm without sockets

0577 18	For 2 x 16 A and / or 32 A sockets	1408	4
0577 19	For 1 x 16 A or 32 A socket and 1 x 63 A socket	1390	2
0577 14	For 3 x 16 A sockets	1606	4
0577 16	Blanking plate	938	4

Bold Cat.Nos are products normally available with Legrand (India) Stockists. Cat.Nos that are not bold - delivery within 4 - 8 weeks from the date of order. Bold packing quantity is our mandatory packing. Orders to be placed by Legrand (India) Stockist in multiples of the same.



0573 00



0577 10



0577 05



0577 12



0577 11



0577 04



0577 18



0577 16



5555 59



5555 89



5555 29



5555 09

Hypra industrial plugs and sockets

Cat.Nos	Polarity	MRP* ₹ / Unit	Pack
---------	----------	------------------	------

Sockets

Prisinter panel mounting sockets - IP 44, IK 09

0520 02	230 V, 16 A, 2P+E	11974	1/10
0527 02	230 V, 32 A, 2P+E	12810	1/6
0529 03	415 V, 32 A, 3P+E	13130	1/6
0529 04	415 V, 32 A, 3P+N+E	15602	1/6
0536 04	415 V, 63 A, 3P+N+E	39994	1

Panel mounting sockets - inclined IP 44, IK 09

0522 23	415 V, 16 A, 3P+E	1910	5/50
0538 23	415 V, 63 A, 3P+E	5966	1

Mobile sockets - IP 44, IK 09

0522 83	415 V, 16 A, 3P+E	4286	5/50
---------	-------------------	------	------

Plugs

Straight plugs - IP 44, IK 09

0520 42	250 V, 16 A, 2P+E	1958	5/50
0527 42	250 V, 32 A, 2P+E	2574	1/5
0522 43	415 V, 16 A, 3P+E	3396	5/50
0529 43	415 V, 32 A, 3P+E	3228	5/50
0529 44	415 V, 32 A, 3P+N+E	3576	5/15
0538 43	415 V, 63 A, 3P+E	8536	1/5
0538 44	415 V, 63 A, 3P+N+E	11470	1/5

Metra plugs and sockets

Plugs

Ivory

6500 22	240 V, 10 A, 2P+E	160	1/5/100
6500 28	240 V, 20 A, 2P+E	170	1/5/100

Grey

6500 02	240 V, 10 A, 2P+E	160	1/5/100
6500 08	240 V, 20 A, 2P+E	170	1/5/100
6500 10	440 V, 20 A, 3P+E	228	1/5/100
6500 16	440 V, 32 A, 3P+E	426	1/5/100

Sockets

6500 03	240 V, 10 A, 2P+E With blue cap	164	1/5/100
6500 23	240 V, 10 A, 2P+E With ivory cap	164	1/5/100
6500 09	240 V, 20 A, 2P+E With blue cap	188	1/5/100
6500 29	240 V, 20 A, 2P+E With ivory cap	188	1/5/100
6500 11	440 V, 20 A, 3P+E With red cap	252	1/5/100
6500 17	440 V, 32 A, 3P+E With red cap	426	1/5/100

* MRP - Maximum Retail Price Inclusive of all taxes including GST.

Plugs and sockets

Cat.Nos	Description	MRP* ₹ / Unit	Pack
---------	-------------	------------------	------

P17 tempra combined units

With interlocked switched sockets and surface mounting box IP 44

0566 01	250 V, 16 A, 2P+E	6378	1
0566 09	250 V, 32 A, 2P+E	7612	1
0566 13	415 V, 32 A, 3P+E	9206	1
0566 14	415 V, 32 A, 3P+N+E	9118	1

With interlocked switched sockets and surface mounting box IP 55

0566 21	250 V, 16A, 2P+E	7086	1
0566 29	250 V, 32 A, 2P+E	8098	1
0566 33	415 V, 32 A, 3P+E	10266	1
0566 34	415 V, 32 A, 3P+N+E	9860	1

With interlocked switched sockets and surface mounting box IP 44 with DIN rail for 5 module DX³ protection

0566 41	250 V, 16A, 2P+E	6422	1
0566 49	250 V, 32 A, 2P+E	7810	1
0566 53	415 V, 32 A, 3P+E	9156	1
0566 54	415 V, 32 A, 3P+N+E	9072	1

With interlocked switched sockets and surface mounting box IP 66 with DIN rail for 5 module DX³ protection

0566 61	250 V, 16 A, 2P+E	7194	1
0566 69	250 V, 32 A, 2P+E	8348	1
0566 73	415 V, 32 A, 3P+E	9552	1
0566 74	415 V, 32 A, 3P+N+E	9740	1

With interlocked switched sockets and without surface mounting box IP 55

0572 21	250 V, 16 A, 2P+E	6134	1
0572 29	250 V, 32 A, 2P+E	6936	1
0572 33	415 V, 32 A, 3P+E	8236	1
0572 34	415 V, 32 A, 3P+N+E	8996	1
0572 95	415 V, 63 A, 3P+N+E, IP 66	25276	1
0577 00	Base box for 0572 95	3502	1

P17 tempra combined units

with interlocked switched sockets IP 66

0572 98	380 to 415 V, 50/60 Hz, 63 A, 3P + E	20782	1
0589 10	380 to 415 V, 50/60 Hz, 63 A, 3P + N + E	23754	1
0589 18	380 to 415 V, 50/60 Hz, 63 A, 3P + E with provision for 5 module DX ³ protection	27346	1
0572 99	380 to 415 V, 50/60 Hz, 63 A, 3P+N+E with provision for 5 module DX ³ protection	28618	1



0566 09



0566 34



0566 41



0566 74



0572 34



0572 98
0589 10

0589 18
0572 99

Bold Cat.Nos are products normally available with Legrand (India) Stockists. Cat.Nos that are not bold - delivery within 4 - 8 weeks from the date of order. Bold packing quantity is our mandatory packing. Orders to be placed by Legrand (India) Stockist in multiples of the same.

Legrand

a global edifice

Legrand is global specialist in electrical and digital building infrastructures. The Group's headquarter is based at Limoges, France. Legrand (India), the pioneer of Miniature Circuit Breakers in India, is the Indian subsidiary of Legrand Group. The Group services the needs of residential, commercial, hospitality and industrial sectors.

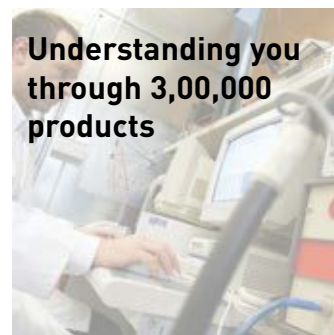
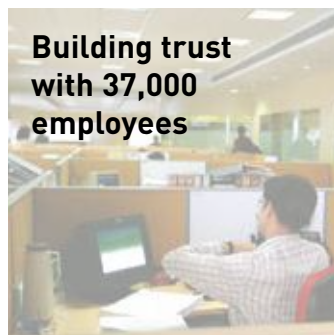

- Manufacturing facilities in 90 countries and sale of products in 180 countries.
- The only company manufacturing low voltage electrical equipments complying to all the important world standards
- World leader in wiring devices and cable management.
- The group designs and manufactures over 100 product families comprising of 3,00,000 products annually, with due emphasis on high performance, simplified installation and user convenience.
- Close to 1/3 of Legrand's capital expenditure is dedicated to the development of new products.
- Every year, Legrand invests around 4.8% of its global turnover on research and development activities involving over 2100 people worldwide.
- More than 100 showrooms around the globe.

Legrand Group Values

Customer Awareness

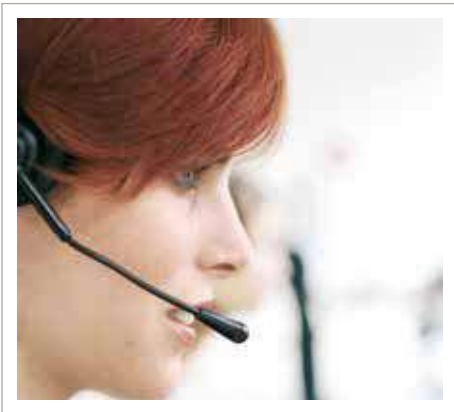

Innovation



Resource Enhancement



Ethical Behaviour



Legrand prestigious projects

- > Some of the prestigious projects we have been proud to associate with.
- > The group services the needs of residential, commercial, hospitality and industrial projects.

NORTH



Banaras Hindu University at Varanasi



Grand Hyatt – Ireo Group



Patanjali at Haridwar

EAST



NIBM – Kalyani



SBI Institute of Mgmt



THE 42

WEST



711 Club Hotel



Aatlantis



Bombay HSE

SOUTH



Rainbow Children's Hospital



Axon Inter Connector



Penta Legacy

CENTRAL



My Home Vihanga

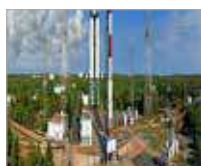

Shar - Sriharikota - AP



Vallabh Bhavan – Bhopal

P17 Tempra Combined Units

closed... it's connected!

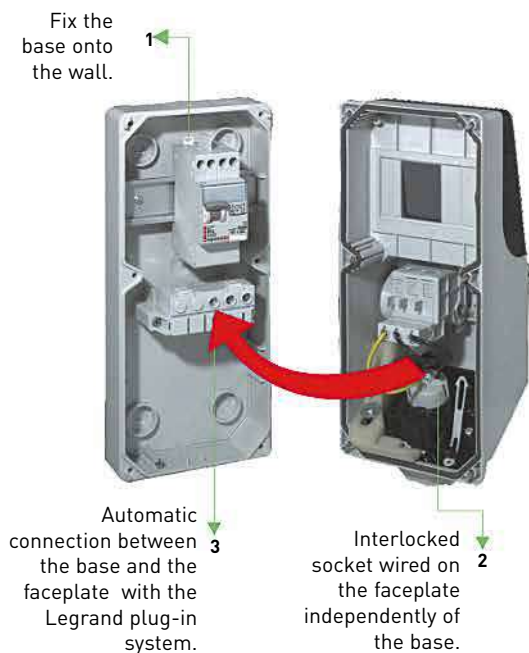

- **Transparent window**
For quick viewing of protection devices.



- **Din rail**
For full access to all Legrand Lexic modular functions upto 5 module.



- **Double interlock**
Switch cannot be turned on unless a plug has been inserted (1st safety position). Plug cannot be removed when the switch is on (2nd safety position).

NOTES :

- All prices are ex our works packed in paper cartons.
- Prices subject to change without notice Prices charged will be as ruling at time of delivery. Any increase in statutory duty will be to customer's account.
- All distribution boards, plug & socket enclosures, metal / plastic one-way enclosures are supplied without devices.
- Arteor™, Myrius™, & Mylinc™ cover plates, DLP trunking, floor boxes, pop-up boxes, Power & data desk grommets, Desktop multi-extension outlets and VDI distribution blocks are supplied without mechanisms.

Warranty policy

Legrand warrants to the original purchaser that the Products (excluding any third party products purchased through Legrand, for which no warranties are made) will be free from defects in material and workmanship, under normal use and regular service, and preventative maintenance for a period of 18 months from the date of shipment or 12 months from the date of installation whichever is earlier. Should any failure to conform with this warranty be found during the Warranty Period, you must notify Legrand of your claim within thirty (30) days of discovery, and within the Warranty Period. Your failure to give notice of claims of breach of warranty within the Warranty Period shall be deemed an absolute and unconditional waiver of claims for such defects. Legrand will have no responsibility to honour claims received after the date the applicable Warranty Period expires. The invoice / bill in original must be produced without which warranty claim shall not be entertained.

This warranty does not cover the following:

- Defect caused due to misuse, alteration, faulty installation, faulty electrical systems, negligent maintenance or misapplication of the product.
- Failure of product or components due to any act of nature; lightning strike, floods, hurricanes, tornadoes, etc. beyond the control of human being.
- Legrand does not warrant any third party products or associated hardware or their performance or suitability for use and application. Such items are provided “as-is”.

Extended warranty policy is applicable for following products,

1. DX³ & RX³ MCB – 5 years if mounted inside Legrand DB
2. Arteor™, Myrius™, Mylinc™, Britzy™ switches (without neon lamp) & Power sockets – 10 years
3. Arteor™, Myrius™, Mylinc™, Britzy™ other products – 2 years

NOTES

.....

.....

.....

.....

.....

.....

.....

.....

.....

.....

.....

.....

.....

.....

.....

.....

.....

.....

.....

.....

.....

.....

.....

.....

.....

.....

.....

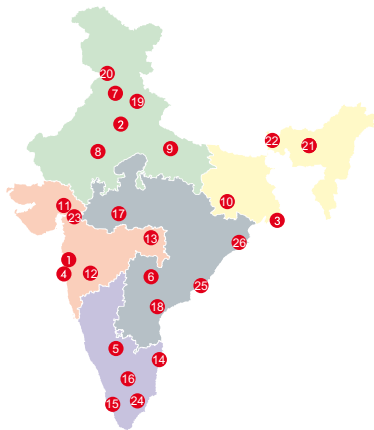

Head office

- 61 & 62, 6th Floor,
Kalpataru Square, Kondivita Road,
Off Andheri-Kurla Road, Andheri (E),
MUMBAI – 400 059.
Tel : (022) 3041 6200
Fax : (022) 3041 6201
Website : www.legrand.co.in

Regional sales offices

- A-25, Mohan Co-operative
Industrial Estate, Mathura Road,
NEW DELHI – 110 044.
Tel : (011) 3990 2200, 2699 0046,
(011) 2699 0028 / 29 / 30 / 31
Fax : (011) 2699 0047
- Bhakta Towers, 2nd & 3rd Floor,
Plot No. KB 22, Sector-III, Saltlake,
KOLKATA – 700 098.
Tel : (033) 4021 3535 / 36
Fax : (033) 4021 3537
- C/203, Corporate Avenue, Atul Projects,
Near Mirador Hotel, Chakala,
Andheri Ghatkopar Link Road,
Andheri – East, **MUMBAI** – 400 099.
Tel : (022) 3385 6200 / 62301000
- Ferozes Manor,
Situating at 58 Hospital Road,
Shivaji Nagar,
BANGALORE – 560 001.
Tel : (080) 6822 0000
- 205-208, 2nd Floor,
Block - II, White House,
Kundan Bagh, Begumpet,
HYDERABAD – 500 016.
Tel : (040) 2341 4398 / 67, 4567 1717
Fax : (040) 4567 1730

Branch offices

- SCO 1-2-3, Second Floor, Sector 17B,
CHANDIGARH – 160 017.
Tel : (0172) 305 8631 / 32 / 33 / 34 / 35
Fax : (0172) 501 9008
- 507-510, Vth Floor, Soni Paris Point,
Jai Singh Highway, Banipark,
JAIPUR – 302 016.
Telefax : (0141) 511 3129, 510 1179
- 209-A, 2nd Floor, Cyber Heights,
Opp. Indira Gandhi Pratishthan,
Vibhuti Khand, Gomti Nagar
LUCKNOW – 226 010.
Tel : (522) 319 2031 / 32 / 33
- 202 & 203, 2nd Floor, Sunrise,
Forum 100, Burdwan Compound, Lalpur,
RANCHI – 834 001.
Tel : (651) 660 5400
- A 101-102, Mondeal Heights,
Besides Novotel Hotel, Sarkhej
Gandhinagar Highway (S G Highway),
AHMEDABAD – 380 015.
Tel : (079) 6134 0555
- 402, Swastik Chambers,
Near Ashwamegh Marriage Hall,
Behind HP Petrol Pump,
Off Karve Road, Erandwane,
PUNE – 411 004.
Tel : (020) 6729 5601 / 602
Fax : (020) 6729 5604
- Plot No.95, II Floor, Shreyash Heights,
VIP Road, Ramdaspath,
NAGPUR – 440 010.
Tel : (0712) 662 7857 / 858
Fax : (0712) 662 7859
- 10 B, (10th Floor), Prestige Center Court
Office Block Vijaya Forum Mall, #183,
N.S.K. Salai, Vadapalani
CHENNAI – 600 026.
Tel : (044) 6612 2800 / 2362 3125 / 35 / 45
Fax : (044) 2362 3165
- J. B. Manjooran Estate, Door No 50/1107A9,
3rd Floor, Bye Pass Junction, Edappally,
COCHIN – 682 024.
Tel : (0484) 280 1921 / 2921, 658 0921
Fax : (0484) 280 1921 / 2921
- B-5, 1st Floor, Thirumalai Towers,
723, Avanashi Road,
COIMBATORE – 641 018.
Tel : (0422) 222 3634 / 0283
Fax : (0422) 222 3164
- 204-205, Megapolis Square,
579, M G Road,
INDORE – 452 001.
Tel : (0731) 393 1650 / 51 / 52
Fax : (0731) 393 1653
- MF-2, Datta's Lords House,
Jammi Chettu Street, Mogalrajapuram,
VIJAYAWADA – 520 010.
Tel : (0866) 661 1393, 664 6393
Fax : (0866) 669 9393

Area offices

- ABC Business Club 16,
Tagore Villa,
DEHRADUN – 248 001.
Tel : (0135) 271 5189
Fax : (0135) 271 5580
- Cabin No. 9,
Second Floor,
Madhok Trade Centre,
Madhok Complex,
Ferozpur Road,
LUDHIANA – 141 001.
Tel : (0161) 277 0301 / 2 / 3 / 4
- House No. 97,
Ground Floor,
Rajgarh Main Road,
Opp. City Heart Nursing Home,
GUWAHATI – 781 007.
Tel : (0361) 245 8498
- 94, Udhm Singh Sarani,
Ground Floor, Ashrampara,
SILIGURI – 734 001.
Tel : (0353) 264 1067
- 405, City Centre, Sosyo Circle,
Udhana Magdalla Road,
SURAT – 395 002.
Tel : (0261) 263 3861
- Aparna Towers, 1st Floor,
2/3, Bypass Road,
MADURAI – 625 010.
Telefax : (0452) 230 8414
- 404, Eshwar Plaza,
Dwaraka Nagar, Main Road,
Beside Bata Show Room,
VISHAKHAPATNAM – 530 016.
Tel : (0891) 663 5652
Fax : (0891) 663 9363
- Plot No. 359,
Saheed Nagar, 2nd Floor,
BHUBANESWAR – 751 007.
Tel : (0674) 254 0623

Technical assistance from Legrand

Telephonic technical assistance for selection of products, technical information, guidance, wiring diagrams and estimation is now made available to you at each Regional Office. Contact the Technical Officer of Legrand at the following telephone numbers

- New Delhi** : Tel.: (011) 2699 0028, 3990 2200
Kolkata : Tel.: (033) 4021 3535 / 36
Mumbai : Tel.: (022) 3385 6200
Bangalore : Tel.: (080) 6822 0000
Hyderabad : Tel.: (040) 2341 4398 / 67, 4567 1717

For other places, contact the nearest
Regional / Branch / Area offices

customer.care@legrand.co.in

