



**LUKER ELECTRIC TECHNOLOGIES PVT.LTD.**

**Regd. Office :** 34/1912-C1, Mattathil Lane, BTS Road, Kochi-682024, Ernakulam, KERALA  
**Corp. Office :** 2nd Floor, Jain Tower, NH-17 Bypass, Opp. Lulu Mall, Edappally, Kochi-682 024, Ph: +91-8129333131, 9746322555 Email: sales@lukerindia.com, **Factory :** 54, Krishnarayapuram Thottasalai, Old Cochin Bypass Road, Chettipalayam, Coimbatore - 641201, Tamilnadu, India, **Tamilnadu :** Coimbatore: No 22, First Floor, R.V Centre, ATT Colony, Park Gate Road, Coimbatore - 641018. 0422 3510202, 8870810999, **Chennai :** No.11/6, Damodaran Street, Chetpet, Chennai-600031, Ph: +91 9940445149, 9944406353, **New Delhi :** Ground Floor, KH No: 53/11/1, Firni Road, Village Mundaka, Pole No.MDKUG71, New Delhi - 110041, Ph: 8510981234, **Karnataka :** #1583, 13th Main, 20th Cross, B-Block, Sahakar Nagar, Bangalore-560092, Ph: 9008487009, **Hyderabad :** Babukhans Millennium Centre, Flat No.106, 1st Floor, Somajiguda, Hyderabad, Ph: 040 23416268, 986 **Kolkata :** 4A, Pollock Street, Swaika Centre,

4th Floor, Room No. 408, Kolkata - 700001

**Representative offices at :** Warrangal - 7893039571, Karim Nagar - 9154398357, Kakinada - 9000554811, Mangalore - 7022119165, Salem - 9994447996 / 9994013192, Thirunelveli - 9994493242, Pondicherry - 9940445149, 9944406353, Madurai - 7708108810, Trichy - 8056180666, Pune - 9890696933, Nagpur - 9850395269, Nasik - 7769091911, Baroda - 9687300643, Raipur - 9399613842, 9827216350, Bhopal - 9300082600, Kolkata - 9831184486, Vijayawada - 8019969551, Visakhapatnam - 9246999368, Guntur - 9700333389, Goa - 9158159062, Indore - 9329754005, Ahmedabad - 9687300643, Surat - 9825506072, Rajkot - 9687300643, Jabalpur - 9407154296, Gwalior - 9329754005, Eluru - 7306613030, Rajahmundry - 9515589339, Tirupati - 9502864799, Khammam - 8801142143, Nizamabad - 9703780070

Luker Electric Technologies Inc.  
1 Cragwood RD STE 103A, S Plainfield, NJ 07080, U S A, Ph: +1 (914) 573-1616, www.lukerus.com

Luker Inc.  
Dean Park Road,  
Scarborough,  
Toronto, Canada

Luker Inc.  
25, Bon Church Road  
ELM Grove  
Brighton, United Kingdom

Luker Electric Technologies  
9, Ivy Court  
Cranbourne North  
Victoria 3977, Melbourne

Luker Electric Tech. LLC  
173, Road 1111/311  
Manama, P.O. Box 1049  
Kingdom of Bahrain

**LED** THE COMPLETE  
LIGHTING SOLUTION

**PRODUCTS  
CATALOGUE**





India needs a strong industrial base that is the product of a huge amount of resources and technology. It is necessary to find out alternatives for optimum utilization of available energy.

Luker Electric Technologies PVT Ltd is a joint venture with Luker USA that has made it gain popularity as the best lighting company in the world. The significant investment in developing new technologies has led the global lighting revolution with the likes of advanced fixtures and lighting solutions.

Being a superior lighting consultant, Luker has a potential of more than 20,000 crores and rapidly growing. The support of central and state governments has enabled the market to grow by leaps and bounds. Named the best lighting company, Luker offers lighting products like bulbs and tubes. With a wide range of LED lighting adhering to international quality, Luker is considered among the topmost brands in India.

Discovering the challenges that the industry is facing, the research and development team has come up with innovations to build Luker as a prominent lighting consultant all over the world. Luker comes with extensive variety, shape, and design, use of colors, energy-saving, etc. It provides consistency in quality and business ethics to the customers and its standards are leading edge.

With the flexibility and adaptability that Luker is promising, it brings the best range of products. The fast pace that the technology is evolving helps ensure it is the best and the future is bright.

#### **Our Business**

Luker has developed and manufactured LED lights of the next-gen that meet local and international standards. It is undoubtedly the best lighting company integrating advanced thermal management, short circuit and open circuit protection including other innovative features. Added to this, the products undergo rigorous testing before it leaves the factories.

The history, experience, and approach to engineering and manufacturing of LEDs ensure that Luker is rated the best and the products stand out from the rest with high quality.

#### **A Brighter Future Ahead**

Luker is being led by clever design and innovative thinking that fuels the drive for being the best lighting company with efficient and premium LED lighting products. It is a product of detailed product design with the help of mechanical engineers to industrial designers and software engineers including experienced electronics engineers for constantly developing the technology.



## **VISION**

At Luker, we are coming together to make the world healthier and more sustainable through innovation. We aim to improve the lives of billions of people. The global reach, deep insights and leading innovations from Luker have positioned us as the makers of the best-LED lights worldwide.



## **MISSION**

Our products deliver the following to the worldwide community:

- Connected products that work for the well being of people
- Integrating informatics with the latest technology
- Real-time guidance devices that are smart to use

While branded LEDs rule the show, they help people make use of energy-efficient options in place of traditional applications of energy.

Luker teams up with industry experts to produce the likes of emergency bulbs so that they provide integrated solutions in lighting designs.



LUKER, J.V. Luker USA has built one of the largest LED manufacturing plant in Asia under "MAKE IN INDIA" concept to promote energy saving products in India.

The manufacturing facility is spread over 21 acres of land with more than 2,65,000 Sq. ft. of built-up area in the Green City of South India, Coimbatore.



## CONTENTS

<i>LED Bulbs</i>	— — — — —	— 1-8
<i>LED Tube Lights</i>	— — — — —	— 1-8
<i>IRIS LED Slim panel lights</i>	— — — — —	— 1-8
<i>IRIS LED Cleanroom Panel Lights</i>	— — — — —	— 1-8
<i>IRIS LED Dimmable Panel Lights</i>	— — — — —	— 1-8
<i>LED Surface Panel Lights</i>	— — — — —	— 1-8
<i>LED IP65 Surface Panel Lights</i>	— — — — —	— 1-8
<i>LIVIANO LED Slim Panel Lights</i>	— — — — —	— 1-8
<i>LED Down Lights</i>	— — — — —	— 1-8
<i>LED Concealed COB Down Lights</i>	— — — — —	— 1-8
<i>LED Surface COB Down Lights</i>	— — — — —	— 1-8
<i>LED Focus Lights</i>	— — — — —	— 1-8
<i>LED Zoom Lights</i>	— — — — —	— 1-8
<i>LED Track Lights</i>	— — — — —	— 1-8
<i>LED Magnetic Track Lights</i>	— — — — —	— 1-8
<i>LED Strip Indoor</i>	— — — — —	— 1-8
<i>LED Strip Outdoor</i>	— — — — —	— 1-8
<i>LED Strip Drivers</i>	— — — — —	— 1-8
<i>LED Sleek Ceiling Lights</i>	— — — — —	— 1-8
<i>LED Street Lights</i>	— — — — —	— 1-8
<i>LED Sensor Street &amp; Flood Lights</i>	— — — — —	— 1-8
<i>LED Flood Lights</i>	— — — — —	— 1-8
<i>LED Linear Lighting (Assembled)</i>	— — — — —	— 1-8
<i>LED Linear Lighting Components</i>	— — — — —	— 1-8
<i>LED Linear Lighting Strip</i>	— — — — —	— 1-8
<i>LED Emergency Lights</i>	— — — — —	— 1-8
<i>LED Smart Backlit Panel</i>	— — — — —	— 1-8
<i>LED Commercial Solar Street Light</i>	— — — — —	— 1-8





# FOCO HIGH GLOW BULBS



- VOLTAGE  
AC 100-300 V
- BEAM ANGLE  
120°
- Temp.  
-10°C ~ 50°C
- PF  
>0.95
- CRI  
>80
- LED  
SMD

# FOCO HIGH GLOW BULBS



Product Code	Wattage	Voltage	Power Factor	System Luminous Efficacy	CRI	LED Light Source	Beam Angle	CCT	IP Rating	Surge Voltage	Base
<b>LBCOL05</b>	0.5W	230V	>0.95	80 LM/W	>80	SMD	120°	WH,BL GR,YL,RD,PK	IP20	2 KV	B22
<b>LBPC03CL</b>	3W	230V	>0.95	110 LM/W 95 LM/W	>80	SMD	120°	WH WW	IP20	3 KV	B22/E27
<b>LBPC05CL</b>	5W	230V	>0.95	110 LM/W	>80	SMD	120°	WH	IP20	3 KV	B22/E27
<b>LBPC07CL</b>	7W	230V	>0.95	110 LM/W	>80	SMD	120°	WH	IP20	3 KV	B22/E27
<b>LBPC09CL</b>	9W	230V	>0.95	110 LM/W	>80	SMD	120°	WH	IP20	3 KV	B22/E27
<b>LBPC12CL</b>	12W	230V	>0.95	110 LM/W	>80	SMD	120°	WH	IP20	3 KV	B22/E27
<b>LBPC15CL</b>	15W	230V	>0.95	110 LM/W	>80	SMD	120°	WH	IP20	3 KV	B22/E27
<b>LBPC18CL</b>	18W	230V	>0.95	110 LM/W	>80	SMD	120°	WH	IP20	3 KV	B22/E27
<b>LBPC05CL</b>	5W	230V	>0.95	95 LM/W	>80	SMD	120°	WW	IP20	3 KV	B22/E27
<b>LBPC07CL</b>	7W	230V	>0.95	95 LM/W	>80	SMD	120°	WW	IP20	3 KV	B22/E27
<b>LBPC09CL</b>	9W	230V	>0.95	95 LM/W	>80	SMD	120°	WW	IP20	3 KV	B22/E27
<b>LBPC12CL</b>	12W	230V	>0.95	95 LM/W	>80	SMD	120°	WW	IP20	3 KV	B22/E27
<b>LBPC15CL</b>	15W	230V	>0.95	95 LM/W	>80	SMD	120°	WW	IP20	3 KV	B22/E27
<b>LBPC18CL</b>	18W	230V	>0.95	95 LM/W	>80	SMD	120°	WW	IP20	3 KV	B22/E27

### Dimension (in mm)

WATTAGE	DIA	HEIGHT
0.5W	69	45
3W	50	90
5W	60	112
7W	60	112
9W	60	112
12W	60	117
15W	70	132
18W	80	144

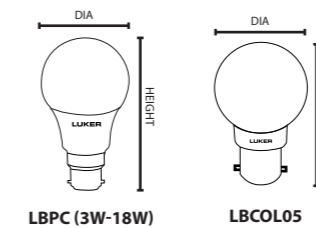

### Product Features

- Rated Life : 30000 Hrs
- Mounting Type : B22/E27 Holder
- Housing & Finish : PBT with Aluminium Heat Sink + PC Diffuser

### Applications

Houses, Hotels, Restaurants, Warehouse





# FOCO HIGH GLOW BULBS



# STELLO HIGH GLOW BULBS

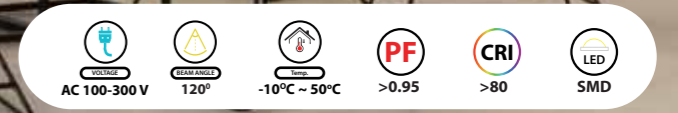

Product Code	Wattage	Voltage	Power Factor	System Luminous Efficacy	CRI	LED Light Source	Beam Angle	CCT	IP Rating	Surge Voltage	Base
LBPC30	30W	230V	>0.95	100 LM/W	>80	SMD	120°	WH WW	IP20	3 KV	B22/E27
LBPC36N	36W	230V	>0.95	100 LM/W	>80	SMD	120°	WH WW	IP20	3 KV	B22/E27
LBPC48N	48W	230V	>0.95	100 LM/W	>80	SMD	120°	WH WW	IP20	3 KV	B22/E27

### Dimension (in mm)

WATTAGE	DIA	HEIGHT
30W	96	157
36W	111	203
48W	136	226

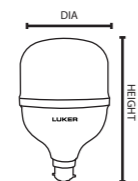

LBPC (30W-48W)

### Product Features

Holder Type : B22/E27  
 Rated Life : 30000 Hrs  
 Mounting Type : B22/E27 Holder  
 Housing & Finish : PBT with Aluminium Heat Sink + PC Diffuser

### Applications

Houses, Hotels, Restaurants, Warehouse



Product Code	Wattage	Voltage	Power Factor	System Luminous Efficacy	CRI	LED Light Source	Beam Angle	CCT	IP Rating	Surge Voltage	Base
LBPC12ST	12W	230V	>0.95	110 LM/W	>80	SMD	120°	WH	IP20	3 KV	B22/E27
LBPC15ST	15W	230V	>0.95	110 LM/W	>80	SMD	120°	WH	IP20	3 KV	B22/E27
LBPC18ST	18W	230V	>0.95	110 LM/W	>80	SMD	120°	WH	IP20	3 KV	B22/E27

### Dimension (in mm)

WATTAGE	DIA	HEIGHT
12W	63.6	124.4
15W	64.2	125.2
18W	72	144.2



### Product Features

Holder Type : B22/E27  
 Rated Life : 30000 Hrs  
 Mounting Type : B22/E27 Holder  
 Housing & Finish : PBT with Aluminium Heat Sink + PC Diffuser

### Applications

Houses, Hotels, Restaurants, Warehouse





# GIALLO CANDLE BULB



# GIALLO FILAMENT BULB



AC 100-300 V
 120°
 -10°C ~ 50°C
 >0.95
 >80
 SMD

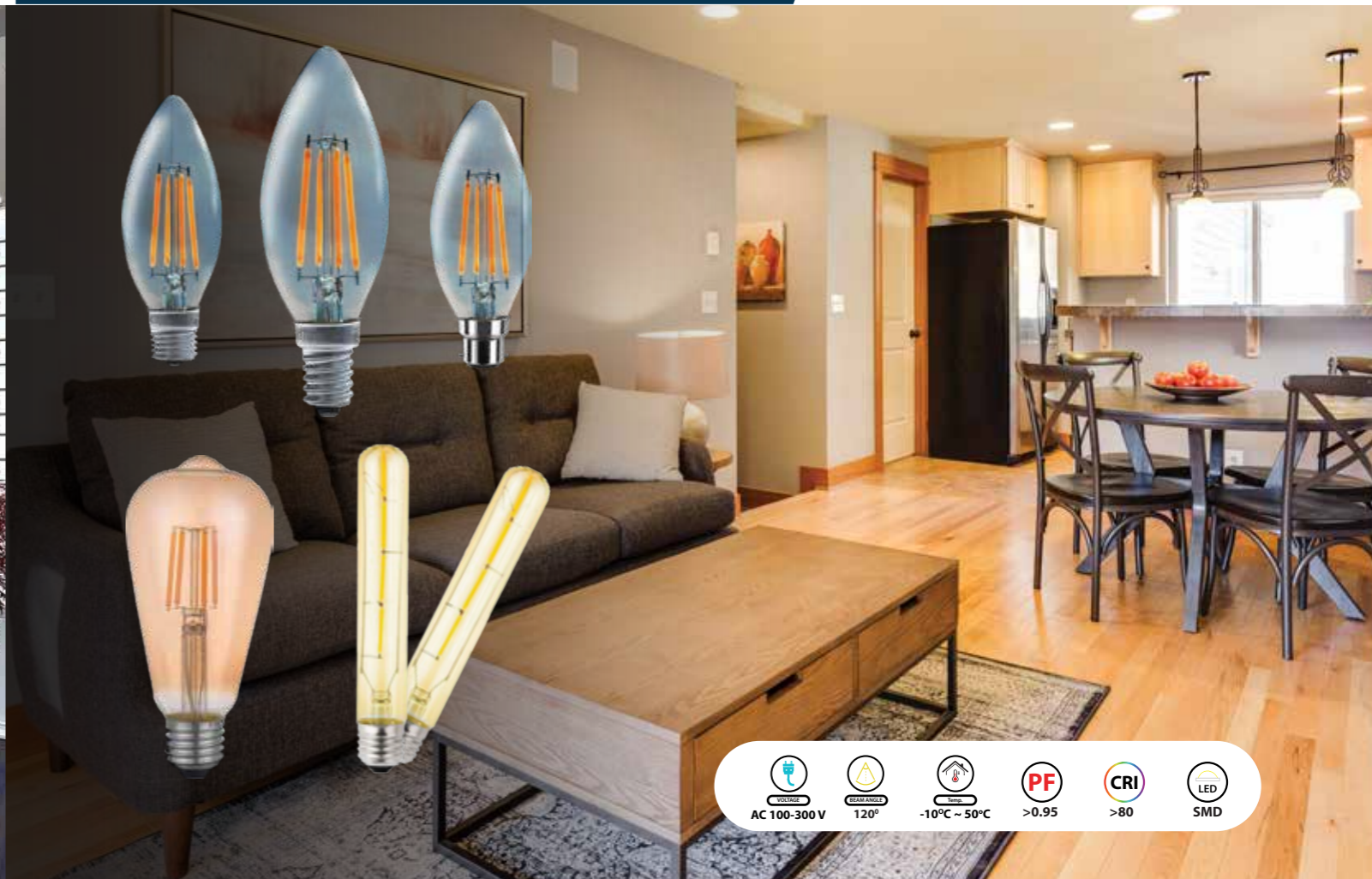

AC 100-300 V
 120°
 -10°C ~ 50°C
 >0.95
 >80
 SMD

Product Code	Wattage	Voltage	Power Factor	System Luminous Efficacy	CRI	LED Light Source	Beam Angle	CCT	IP Rating	Surge Voltage	Base
<b>LBGC03</b>	3W	230V	>0.95	100 LM/W	>80	SMD	120°	WH WW	IP20	2 KV	B22/E27 /E14
<b>LBGC05</b>	5W	230V	>0.95	100 LM/W	>80	SMD	120°	WH WW	IP20	2 KV	B22/E27 /E14

### Dimension (in mm)

WATTAGE	DIA	HEIGHT
3W	36	98.9
5W	36	98.9

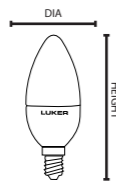

### Product Features

Rated Life : 30000 Hrs  
 Mounting Type : B22/E27/E14 Holder  
 Housing & Finish : PBT with Aluminium Heat Sink + PC Diffuser

### Applications

Houses, Hotels, Restaurants, Warehouse

Product Code	Wattage	Voltage	Power Factor	System Luminous Efficacy	CRI	LED Light Source	Beam Angle	CCT	IP Rating	Surge Voltage	Base
<b>LBFB2204</b>											B22
<b>LBFE2704</b>	4W	230V	>0.95	100 LM/W	>80	SMD	180°	WH, WW	IP20	2 KV	E27
<b>LBFE1404</b>											E14
<b>LBFE2704 AM ST64</b>	4W	230V	>0.95	100 LM/W	>80	SMD	180°	WW(2000K)	IP20	2 KV	E27
<b>LBFE2704 AM T225</b>	4W	230V	>0.95	100 LM/W	>80	SMD	180°	WW(2000K)	IP20	2 KV	E27

### Dimension (in mm)

PRODUCT CODE	DIA	HEIGHT
LBFB2204 LBFE2704 LBFE1404	35	90
LBFE2704 AM ST64	64.3	143
LBFE2704 AM T225	28	219.5

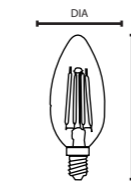

LBFB2204 (4W)

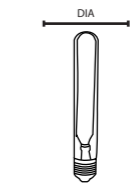

LBFE2704 AM ST64 (4W)

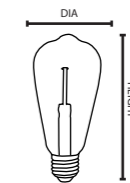

LBFE2704 AM T225(4W)

### Product Features

Rated Life : 30000 Hrs  
 Mounting Type : B22/E27/E14 Holder  
 Housing & Finish : Glass body & Clear diffuser

### Applications

Houses, Hotels, Restaurants, Warehouse







***LUMOS LED TUBE LIGHTS***



# LUMOS ECCO PC TUBES

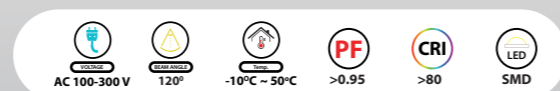

# LUMOS PRIMO ALUMINIUM TUBES

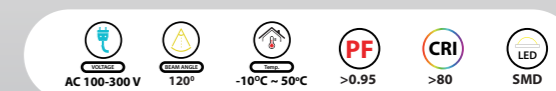
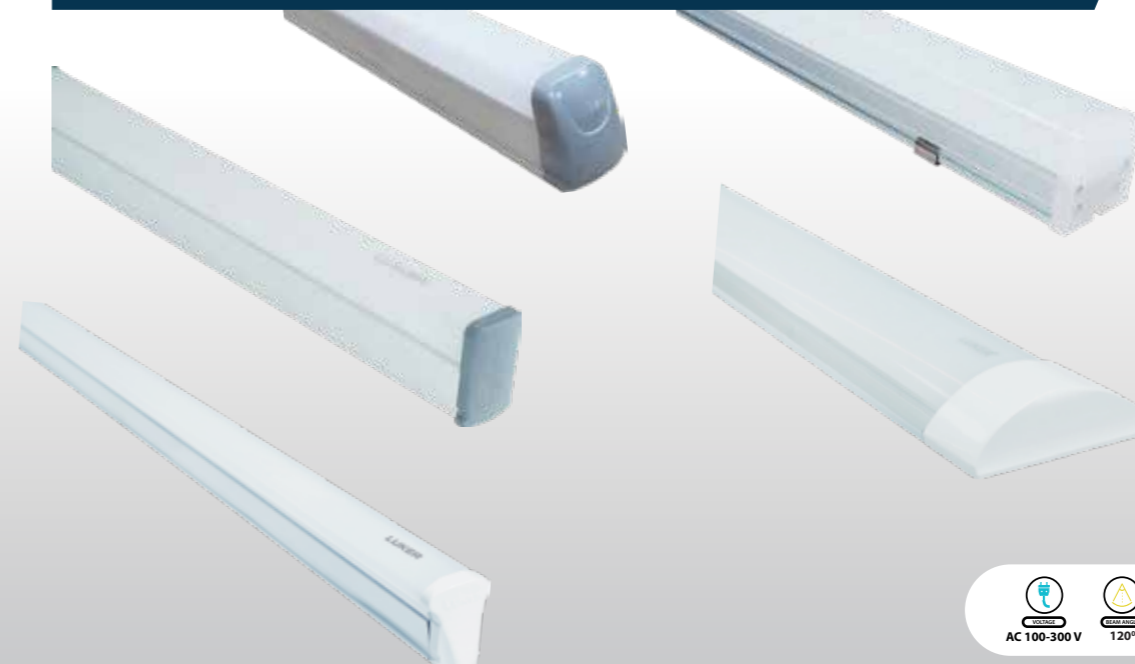

Product Code	Wattage	Voltage	Power Factor	System Luminous Efficacy	CRI	LED Light Source	Beam Angle	CCT	IP Rating	Surge Voltage	THD
LT505P	5W	230V	>0.95	100 LM/W	>80	SMD	120°	WH,WW	IP20	3 KV	<15%
LT510P	10W	230V	>0.95	100 LM/W	>80	SMD	120°	WH,WW	IP20	3 KV	<15%
LT520P	20W	230V	>0.95	100 LM/W	>80	SMD	120°	WH,WW NW	IP20	3 KV	<15%
LT524P	24W	230V	>0.95	100 LM/W	>80	SMD	120°	WH,WW	IP20	3 KV	<15%
LT-26W	26W	230V	>0.95	100 LM/W	>80	SMD	120°	WH	IP20	3 KV	<15%

## Dimension (in mm)

PRODUCT CODE	LENGTH	WIDTH	HEIGHT
LT505P	288	20.4	31.6
LT510P	570	20	33
LT520P	1180	21	35.7
LT524P	1180	21.8	36.8
LT-26W	1180	21.8	36.8

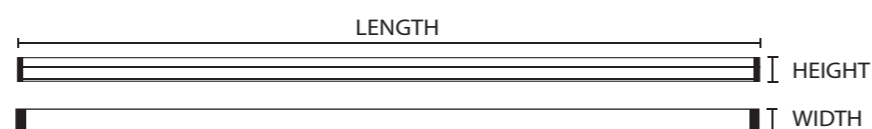

## Product Features

Rated Life : 30000 Hrs  
 Mounting Type : Surface Mounted  
 Housing & Finish : Poly Carbonate Body + PC Diffuser

## Applications

Houses, Offices, Hospitals, Showrooms



Product Code	Wattage	Voltage	Power Factor	System Luminous Efficacy	CRI	LED Light Source	Beam Angle	CCT	IP Rating	Surge Voltage	THD
LT520	20W	230V	>0.95	100 LM/W	>80	SMD	120°	WH,WW NW	IP20	3 KV	<15%
LT5M20	20W	230V	>0.95	100 LM/W	>80	SMD	120°	WH,WW	IP20	3 KV	<15%
LT5M24	24W	230V	>0.95	100 LM/W	>80	SMD	120°	WH	IP20	3 KV	<15%
LT832	32W	230V	>0.95	100 LM/W	>80	SMD	120°	WH	IP20	3 KV	<15%
LTH36	36W	230V	>0.95	100 LM/W	>80	SMD	120°	WH,WW	IP20	3 KV	<15%
LTH40	40W	230V	>0.95	100 LM/W	>80	SMD	120°	WH,WW	IP20	3 KV	<15%

## Dimension (in mm)

PRODUCT CODE	LENGTH	WIDTH	HEIGHT
LT520	1180	20	31.8
LT5M20	1200	21.4	36.9
LT5M24	1200	21.4	36.9
LT832	1208	29	37
LTH36	1205	72.9	23.8
LTH40	1190	50.7	44.2

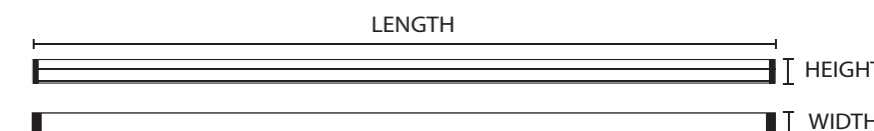

## Product Features

Rated Life : 30000 Hrs  
 Mounting Type : Surface Mounted  
 Housing & Finish : Aluminium + PC Diffuser

## Applications

Houses, Offices, Hospitals, Showrooms





# LUMOS OUTDOOR TUBE SET



# LUMOS SENZA SENSOR TUBE SET

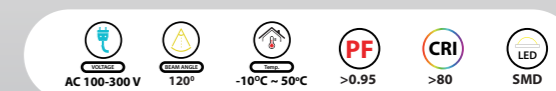
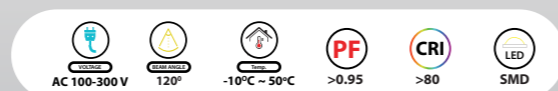
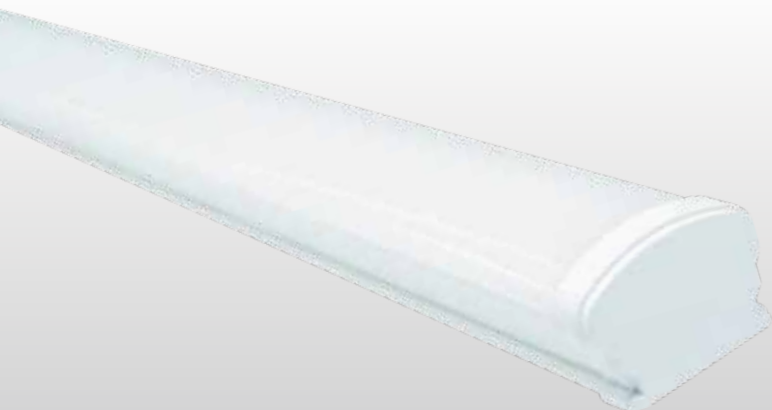

Product Code	Wattage	Voltage	Power Factor	System Luminous Efficacy	CRI	LED Light Source	Beam Angle	CCT	IP Rating	Surge Voltage	THD
LTOD40	36W	230V	>0.95	100 LM/W	>80	SMD	120°	WH,WW	IP65	3 KV	<15%

### Dimension (in mm)

PRODUCT CODE	LENGTH	WIDTH	HEIGHT
LTOD40	1200	49	46.7

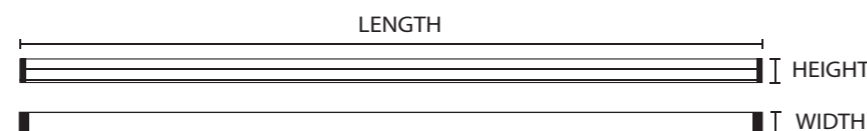

### Product Features

Rated Life : 30000 Hrs  
 Mounting Type : Surface Mounted  
 Housing & Finish : ABS Plastic Body + PC Diffuser

### Applications

Cold Storage, Hatchery, Industries, Warehouse

Product Code	Wattage	Voltage	Power Factor	System Luminous Efficacy	CRI	LED Light Source	Beam Angle	CCT	IP Rating	Surge Voltage	THD
LT809SR	9W	230V	>0.95	100 LM/W	>80	SMD	120°	WH,WW NW	IP20	3 KV	<15%
LT818SR	18W	230V	>0.95	100 LM/W	>80	SMD	120°	WH,WW NW	IP20	3 KV	<15%
LT1818TSR	18W	230V	>0.95	100 LM/W	>80	SMD	120°	WH,WW NW	IP20	3 KV	<15%

### Dimension (in mm)

PRODUCT CODE	LENGTH	WIDTH	HEIGHT
LT809SR	573	30	37
LT818SR	1183	30	37

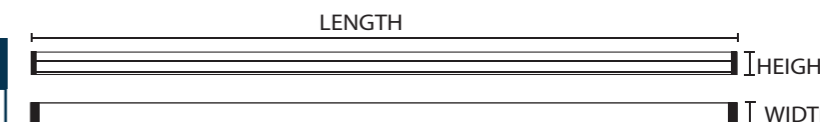

PRODUCT CODE	DIA	L1	L2
LT1818TSR	32	1203	1215

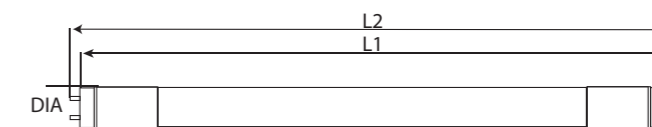

### Product Features

Rated Life : 30000 Hrs  
 Mounting Type : Surface Mounted  
 Housing & Finish : Aluminium + PC Diffuser

### Applications

Houses, Offices, Hospitals, Warehouse, Corridor





# LUMOS HIGH LUMEN TUBES

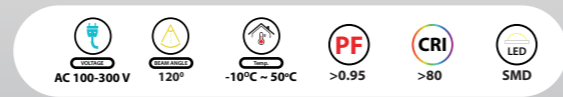

# LUMOS LED RETROFIT TUBES

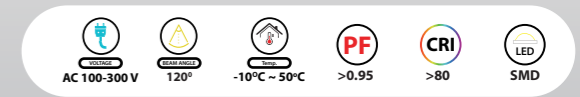

Product Code	Wattage	Voltage	Power Factor	System Luminous Efficacy	CRI	LED Light Source	Beam Angle	CCT	IP Rating	Surge Voltage	THD
LT12402	40W	230V	>0.95	100 LM/W	>80	SMD	120°	WH	IP20	3 KV	<15%
LT12402R	40W	230V	>0.95	100 LM/W	>80	SMD	120°	WH	IP20	3 KV	<15%
LT1260	60W	230V	>0.95	100 LM/W	>80	SMD	120°	WH	IP20	3 KV	<15%
LT1260R	60W	230V	>0.95	100 LM/W	>80	SMD	120°	WH	IP20	3 KV	<15%

## Dimension (in mm)

PRODUCT CODE	LENGTH	WIDTH	HEIGHT
LT12402	602	49	38
LT12402R	602	95	36
LT1260	1185	48	34
LT1260R	1185	90	40

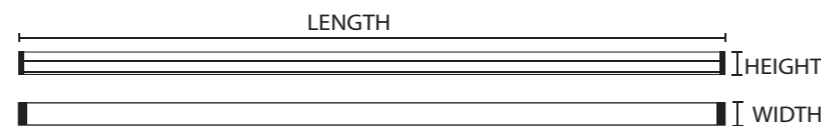

## Product Features

Rated Life : 30000 Hrs  
 Mounting Type : Surface Mounted  
 Housing & Finish : Poly Carbonate Body + PC Diffuser

## Applications

Houses, Offices, Hospitals, Showrooms

Product Code	Wattage	Voltage	Power Factor	System Luminous Efficacy	CRI	LED Light Source	Beam Angle	CCT	IP Rating	Surge Voltage	THD
LT1818T	18W	230V	>0.95	100 LM/W	>80	SMD	120°	WH,WW NW	IP20	3 KV	<15%
LT1818T-5Y	18W	230V	>0.95	100 LM/W	>80	SMD	120°	WH	IP20	3 KV	<15%
LTP818	18W	230V	>0.95	100 LM/W	>80	SMD	120°	WH	IP20	3 KV	<15%

## Dimension (in mm)

PRODUCT CODE	DIA	L1	L2
LT1818T	26.6	1198	1214
LT1818T-5Y	30	1198	1214
LTP818	26	1200	1218

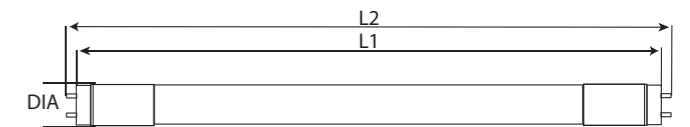

## Product Features

Rated Life : 30000 Hrs  
 Mounting Type : G13 Fixture  
 Housing & Finish : Aluminium + PC Diffuser

## Applications

Houses, Offices, Hospitals, Warehouse, Corridor





# STATO LED RETROFIT BATTENS



# CASO RETROFIT LUMINAIRES (IP65)



Product Code	Wattage	Voltage	Power Factor	System Luminous Efficacy	CRI	LED Light Source	Beam Angle	CCT	IP Rating	Surge Voltage	THD
LLTS1	1x18W	230V	NA	NA	NA	NA	NA	NA	NA	NA	NA
LLTS2	2x18W	230V	NA	NA	NA	NA	NA	NA	NA	NA	NA
LLTS1N	1x18W	230V	NA	NA	NA	NA	NA	NA	NA	NA	NA

### Dimension (in mm)

PRODUCT CODE	LENGTH	WIDTH	HEIGHT
LLTS1	1230	37.6	23
LLTS2	1230	39	22.1
LLTS1N	1235	35.5	30.2

### Product Features

Rated Life : 30000 Hrs  
 Mounting Type : G13 Fixture  
 Housing & Finish : Aluminium + PC Diffuser

### Applications

Houses, Offices, Hospitals, Warehouse, Corridor

Product Code	Wattage	Voltage	Power Factor	System Luminous Efficacy	CRI	LED Light Source	Beam Angle	CCT	IP Rating	Surge Voltage	THD
LOC209	2X9 W	230V	NA	NA	NA	NA	NA	NA	IP65	NA	NA
LOC218	2X18 W	230V	NA	NA	NA	NA	NA	NA	IP65	NA	NA
LOC118	1X18 W	230V	NA	NA	NA	NA	NA	NA	IP65	NA	NA

### Dimension (in mm)

PRODUCT CODE	LENGTH	WIDTH	HEIGHT
LOC209	655	105	55
LOC218	1267	120	57
LOC118	1260	73	64

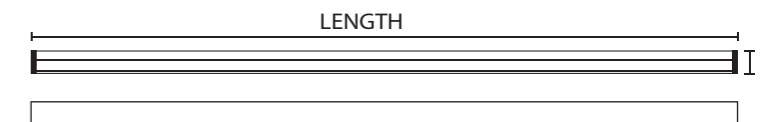

### Product Features

Mounting Type : Surface Mounted  
 Housing & Finish : Poly Carbonate Body + PC Diffuser

### Applications

Domestic, Commercial







***IRIS  
LED SLIM PANEL***



# IRIS LED SLIM PANEL



# IRIS LED SLIM PANEL

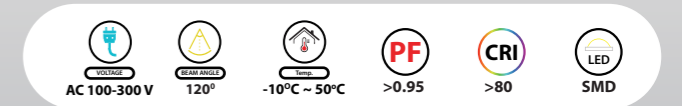
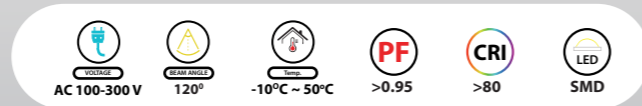

Product Code	Wattage	Voltage	Power Factor	System Luminous Efficacy	CRI	LED Light Source	Beam Angle	CCT	IP Rating	Surge Voltage	THD
LNPR03	3W	230V	>0.95	100 LM/W	>80	SMD	120°	WH,WW NW	IP20	4 KV	<15%
LNPR06*	6W	230V	>0.95	100 LM/W	>80	SMD	120°	WH,WW NW, 3 IN 1	IP20	4 KV	<15%
LNPR09	9W	230V	>0.95	100 LM/W	>80	SMD	120°	WH,WW NW	IP20	4 KV	<15%
LNPR12*	12W	230V	>0.95	100 LM/W	>80	SMD	120°	WH,WW NW, 3 IN 1	IP20	4 KV	<15%
LNPR15	15W	230V	>0.95	100 LM/W	>80	SMD	120°	WH,WW NW	IP20	4 KV	<15%
LNPR18	18W	230V	>0.95	100 LM/W	>80	SMD	120°	WH,WW NW	IP20	4 KV	<15%
LNPR30	30W	230V	>0.95	100 LM/W	>80	SMD	120°	WH,WW NW	IP20	4 KV	<15%

### Dimension (in mm)

PRODUCT CODE	DIA	HEIGHT	CUT-OUT
LNPR03	90	20	73
LNPR06	120	20	102
LNPR09	145	20	125
LNPR12	173	20	153
LNPR15	173	20	153
LNPR18	224	20	203
LNPR30	301	20	272

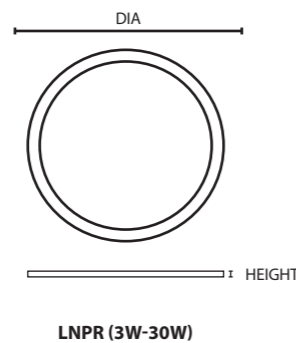

### Product Features

Rated Life : 50000 Hrs  
 Mounting Type : Recess Mounted  
 Housing & Finish : Die Cast Aluminium + PC Diffuser

### Applications

Houses, Offices, Hospitals, Showrooms

\*3 in 1 CCT Model available in 6W and 12W



Product Code	Wattage	Voltage	Power Factor	System Luminous Efficacy	CRI	LED Light Source	Beam Angle	CCT	IP Rating	Surge Voltage	THD
LNPS03	3W	230V	>0.95	100 LM/W	>80	SMD	120°	WH,WW NW	IP20	4 KV	<15%
LNPS06*	6W	230V	>0.95	100 LM/W	>80	SMD	120°	WH,WW NW, 3 IN 1	IP20	4 KV	<15%
LNPS09	9W	230V	>0.95	100 LM/W	>80	SMD	120°	WH,WW NW	IP20	4 KV	<15%
LNPS12*	12W	230V	>0.95	100 LM/W	>80	SMD	120°	WH,WW NW, 3 IN 1	IP20	4 KV	<15%
LNPS15	15W	230V	>0.95	100 LM/W	>80	SMD	120°	WH,WW NW	IP20	4 KV	<15%
LNPS18	18W	230V	>0.95	100 LM/W	>80	SMD	120°	WH,WW NW	IP20	4 KV	<15%
LNPS30	30W	230V	>0.95	100 LM/W	>80	SMD	120°	WH,WW NW	IP20	4 KV	<15%

### Dimension (in mm)

PRODUCT CODE	LENGTH	WIDTH	HEIGHT	CUT-OUT
LNPS03	90	90	20	73 X 73
LNPS06	120	120	20	102 X 102
LNPS09	145	145	20	125 X 125
LNPS12	173	173	20	153 X 153
LNPS15	173	173	20	153 X 153
LNPS18	224	224	20	203 X 203
LNPS30	301	301	20	272 X 272

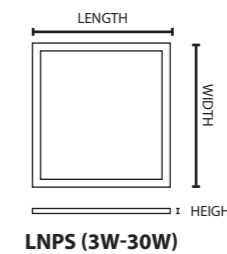

### Product Features

Rated Life : 50000 Hrs  
 Mounting Type : Recess Mounted  
 Housing & Finish : Die Cast Aluminium + PC Diffuser

### Applications

Houses, Offices, Hospitals, Showrooms

\*3 in 1 CCT Model available in 6W and 12W





# IRIS LED SLIM PANEL



# IRIS CLEANROOM & DIMMABLE PANEL

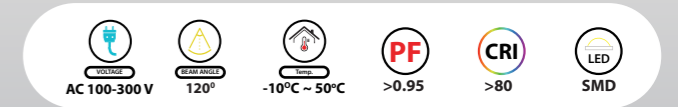
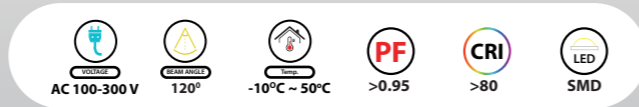

Product Code	Wattage	Voltage	Power Factor	System Luminous Efficacy	CRI	LED Light Source	Beam Angle	CCT	IP Rating	Surge Voltage	THD
LPS40	40W	230V	>0.95	100 LM/W	>80	SMD	120°	WH,WW NW	IP20	4 KV	<15%
LPS48	48W	230V	>0.95	100 LM/W	>80	SMD	120°	WH	IP20	4 KV	<15%
LPS42	40W	230V	>0.95	100 LM/W	>80	SMD	120°	WH	IP20	4 KV	<15%
LPS4812	48W	230V	>0.95	100 LM/W	>80	SMD	120°	WH,WW NW	IP20	4 KV	<15%

Product Code	Wattage	Voltage	Power Factor	System Luminous Efficacy	CRI	LED Light Source	Beam Angle	CCT	IP Rating	Surge Voltage	THD
LPS40IP65	40W	230V	>0.95	100 LM/W	>80	SMD	120°	NW	IP65	4 KV	<15%
LKM2240IP65	40W	230V	>0.95	100 LM/W	>80	SMD	120°	WH	IP65	4 KV	<15%
LPSD40*	40W	230V	>0.95	100 LM/W	>80	SMD	120°	WH,WW NW	IP20	4 KV	<15%

\*ANALOG (0-10V) DIMMABLE SLIMPANEL

## Dimension (in mm)

PRODUCT CODE	LENGTH	WIDTH	HEIGHT	CUT-OUT
LPS40	595	595	9	570 X 570
LPS48	595	595	9	570 X 570
LPS42	1195	150	8	1170 X 140
LPS4812	1195	295	8	1170 X 270

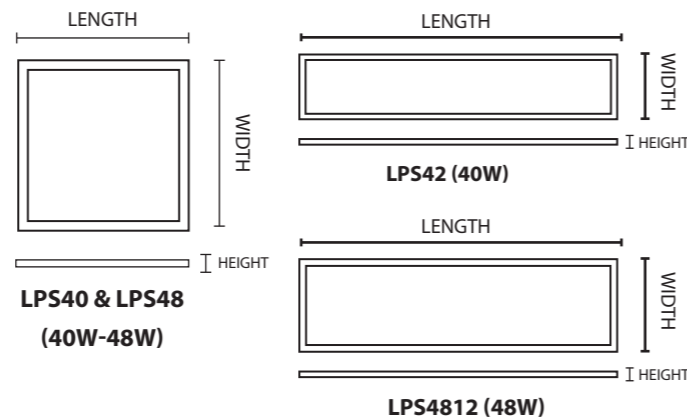

## Product Features

- Rated Life : 50000 Hrs
- Mounting Type : Recess Mounted
- Housing & Finish : Die Cast Aluminium + PC Diffuser

## Applications

Houses, Offices, Hospitals, Showrooms



## Dimension (in mm)

PRODUCT CODE	LENGTH	WIDTH	HEIGHT	CUT-OUT
LPS40IP65	595	595	19	570 X 570
LKM2240IP65	595	595	35	570 X 570
LPSD40	595	595	19	570 X 570

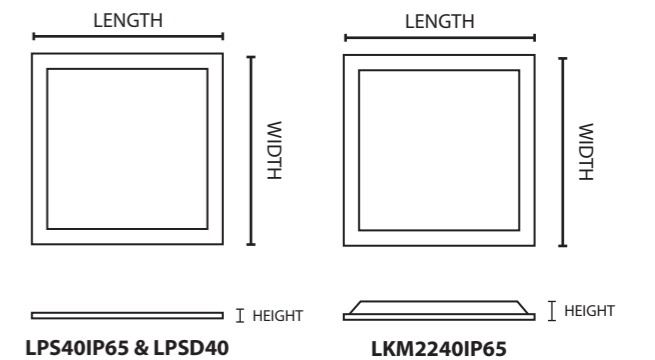

## Product Features

- Rated Life : 50000 Hrs
- Mounting Type : Recess Mounted
- Housing & Finish : Die Cast Aluminium + PC Diffuser

## Applications

Houses, Offices, Hospitals, Showrooms







***SURFACE PANEL LIGHTS***





# IRIS LED SURFACE PANEL



# IRIS LED SURFACE PANEL

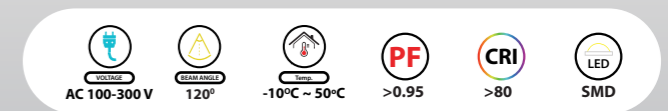
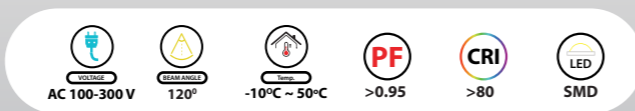

Product Code	Wattage	Voltage	Power Factor	System Luminous Efficacy	CRI	LED Light Source	Beam Angle	CCT	IP Rating	Surge Voltage	THD
LNPSRS03	3W	230V	>0.95	100 LM/W	>80	SMD	120°	WH,WW	IP20	4 KV	<15%
LNPSRS06	6W	230V	>0.95	100 LM/W	>80	SMD	120°	WH,WW NW	IP20	4 KV	<15%
LNPSRS12	12W	230V	>0.95	100 LM/W	>80	SMD	120°	WH,WW NW	IP20	4 KV	<15%
LNPSRS18	18W	230V	>0.95	100 LM/W	>80	SMD	120°	WH,WW NW	IP20	4 KV	<15%
LNPSRS30	30W	230V	>0.95	100 LM/W	>80	SMD	120°	WH,WW NW	IP20	4 KV	<15%
LNPSRS40	40W	230V	>0.95	100 LM/W	>80	SMD	120°	WH,WW NW	IP20	4 KV	<15%
LNPSRS48	48W	230V	>0.95	100 LM/W	>80	SMD	120°	WH	IP20	4 KV	<15%

### Dimension (in mm)

PRODUCT CODE	LENGTH	WIDTH	HEIGHT
LNPSRS03	88	88	35
LNPSRS06	118	118	35
LNPSRS12	178	178	35
LNPSRS18	240	240	35
LNPSRS30	300	300	35
LNPSRS40	600	600	35
LNPSRS48	1200	300	35

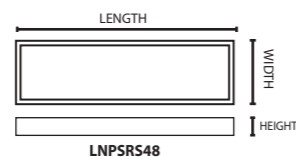
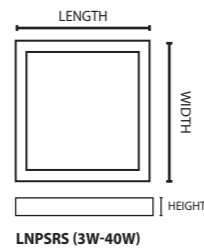

### Product Features

Rated Life : 50000 Hrs  
 Mounting Type : Surface Mounted  
 Housing & Finish : Die Cast Aluminium + PC Diffuser

### Applications

Houses, Offices, Hospitals, Showrooms

Product Code	Wattage	Voltage	Power Factor	System Luminous Efficacy	CRI	LED Light Source	Beam Angle	CCT	IP Rating	Surge Voltage	THD
LNPSRR03	3W	230V	>0.95	100 LM/W	>80	SMD	120°	WH,WW	IP20	4 KV	<15%
LNPSRR06	6W	230V	>0.95	100 LM/W	>80	SMD	120°	WH,WW NW	IP20	4 KV	<15%
LNPSRR12	12W	230V	>0.95	100 LM/W	>80	SMD	120°	WH,WW NW	IP20	4 KV	<15%
LNPSRR18	18W	230V	>0.95	100 LM/W	>80	SMD	120°	WH,WW NW	IP20	4 KV	<15%
LNPSRR30	30W	230V	>0.95	100 LM/W	>80	SMD	120°	WH,WW NW	IP20	4 KV	<15%

### Dimension (in mm)

PRODUCT CODE	DIA	HEIGHT
LNPSRR03	88	35
LNPSRR06	118	35
LNPSRR12	178	35
LNPSRR18	240	35
LNPSRR30	300	35

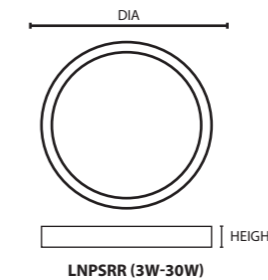

### Product Features

Rated Life : 50000 Hrs  
 Mounting Type : Surface Mounted  
 Housing & Finish : Die Cast Aluminium + PC Diffuser

### Applications

Houses, Offices, Hospitals, Showrooms



# LISO LED TRIMLESS SURFACE PANELS



# LISO LED TRIMLESS SURFACE PANELS

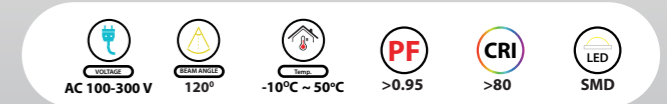
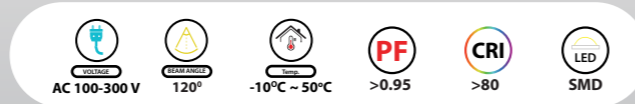
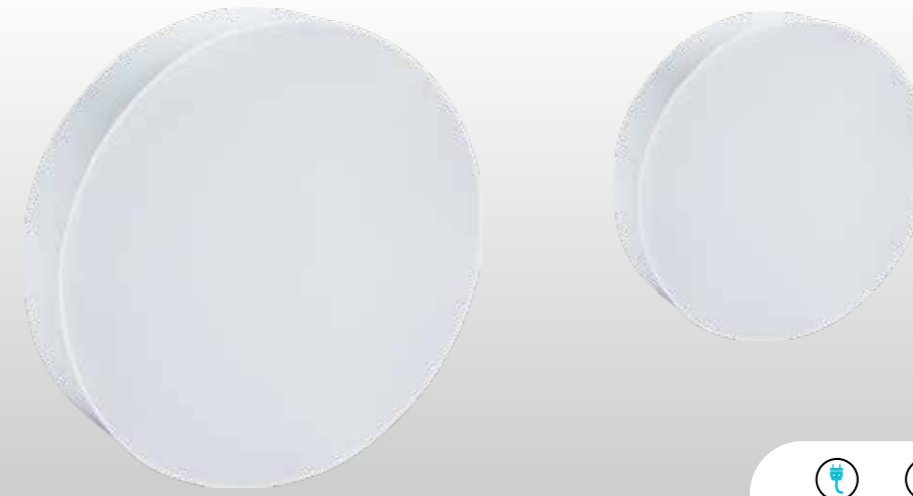
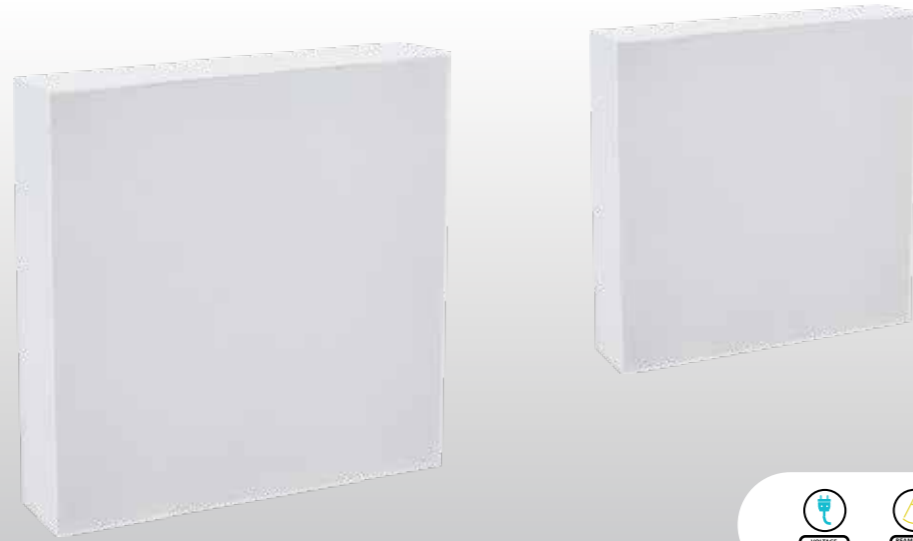

Product Code	Wattage	Voltage	Power Factor	System Luminous Efficacy	CRI	LED Light Source	Beam Angle	CCT	IP Rating	Surge Voltage	THD
<b>LCL6NS</b>	6W	230V	>0.95	100 LM/W	>80	SMD	120°	WH,WW 3 IN 1	IP20	3 KV	<15%
<b>LCL15NS</b>	15W	230V	>0.95	100 LM/W	>80	SMD	120°	WH,WW 3 IN 1	IP20	3 KV	<15%
<b>LCL20NS</b>	20W	230V	>0.95	100 LM/W	>80	SMD	120°	WH,WW 3 IN 1	IP20	3 KV	<15%

Product Code	Wattage	Voltage	Power Factor	System Luminous Efficacy	CRI	LED Light Source	Beam Angle	CCT	IP Rating	Surge Voltage	THD
<b>LCL6NR</b>	6W	230V	>0.95	100 LM/W	>80	SMD	120°	WH,WW 3 IN 1	IP20	3 KV	<15%
<b>LCL15NR</b>	15W	230V	>0.95	100 LM/W	>80	SMD	120°	WH,WW 3 IN 1	IP20	3 KV	<15%
<b>LCL20NR</b>	20W	230V	>0.95	100 LM/W	>80	SMD	120°	WH,WW 3 IN 1	IP20	3 KV	<15%

### Dimension (in mm)

PRODUCT CODE	LENGTH	WIDTH	HEIGHT
LCL6NS	100	100	30
LCL15NS	140	140	30
LCL20NS	180	180	30

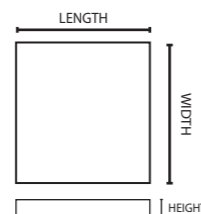

### Product Features

Rated Life : 30000 Hrs  
 Mounting Type : Surface Mounted  
 Housing & Finish : ABS Plastic Body + PC Diffuser

### Applications

Houses, Offices, Hospitals, Showrooms



### Dimension (in mm)

PRODUCT CODE	DIA	HEIGHT
LCL6NR	100	30
LCL15NR	140	30
LCL20NR	180	30

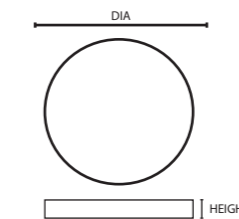

### Product Features

Rated Life : 30000 Hrs  
 Mounting Type : Surface Mounted  
 Housing & Finish : ABS Plastic Body + PC Diffuser

### Applications

Houses, Offices, Hospitals, Showrooms





# LISO DOB LED TRIMLESS SURFACE PANEL



# LISO DOB LED TRIMLESS SURFACE PANEL

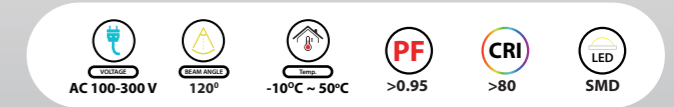
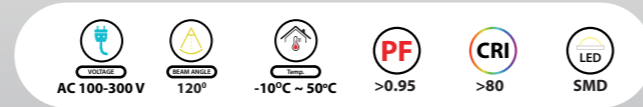
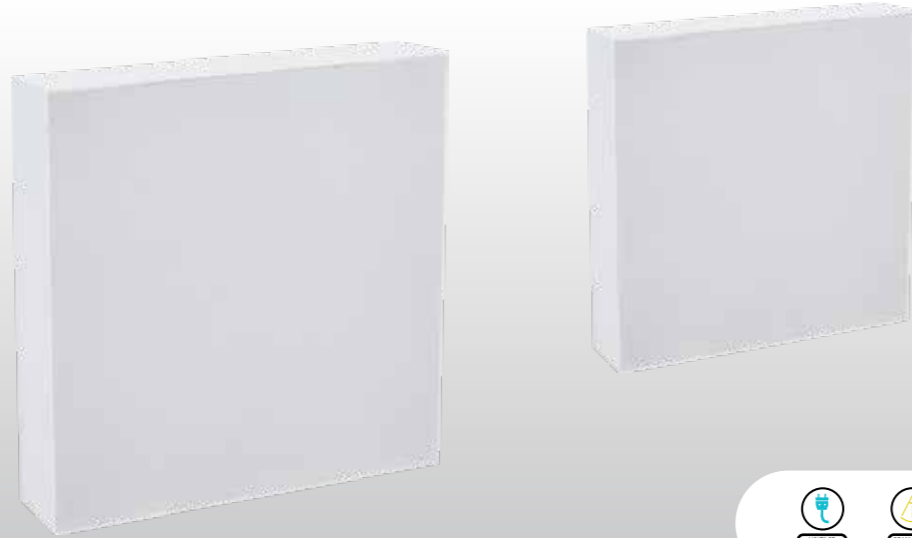

Product Code	Wattage	Voltage	Power Factor	System Luminous Efficacy	CRI	LED Light Source	Beam Angle	CCT	IP Rating	Surge Voltage	THD
LCL8NS	8W	230V	>0.95	100 LM/W	>80	SMD	120°	WH,WW	IP20	3 KV	<15%
LCL12NS	12W	230V	>0.95	100 LM/W	>80	SMD	120°	WH,WW	IP20	3 KV	<15%
LCL18NS	18W	230V	>0.95	100 LM/W	>80	SMD	120°	WH,WW	IP20	3 KV	<15%

Product Code	Wattage	Voltage	Power Factor	System Luminous Efficacy	CRI	LED Light Source	Beam Angle	CCT	IP Rating	Surge Voltage	THD
LCL8NR	8W	230V	>0.95	100 LM/W	>80	SMD	120°	WH,WW	IP20	3 KV	<15%
LCL12NR	12W	230V	>0.95	100 LM/W	>80	SMD	120°	WH,WW	IP20	3 KV	<15%
LCL18NR	18W	230V	>0.95	100 LM/W	>80	SMD	120°	WH,WW	IP20	3 KV	<15%

### Dimension (in mm)

PRODUCT CODE	LENGTH	WIDTH	HEIGHT
LCL8NS	90	90	25
LCL12NS	120	120	25
LCL18NS	155	155	25

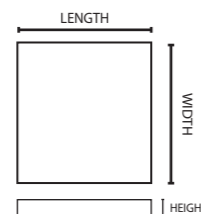

### Product Features

- Rated Life : 30000 Hrs
- Mounting Type : Surface Mounted
- Housing & Finish : ABS Plastic Body + PC Diffuser

### Applications

Houses, Offices, Hospitals, Showrooms



PRODUCT CODE	DIA	HEIGHT
LCL8NR	90	25
LCL12NR	120	25
LCL18NR	155	25

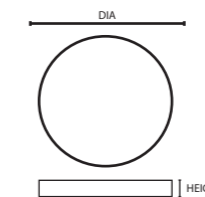

### Product Features

- Rated Life : 30000 Hrs
- Mounting Type : Surface Mounted
- Housing & Finish : ABS Plastic Body + PC Diffuser

### Applications

Houses, Offices, Hospitals, Showrooms





# GESTO IP65 LED SURFACE PANEL

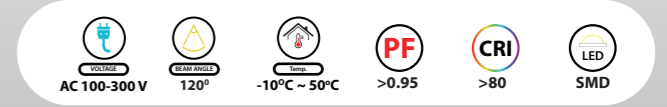
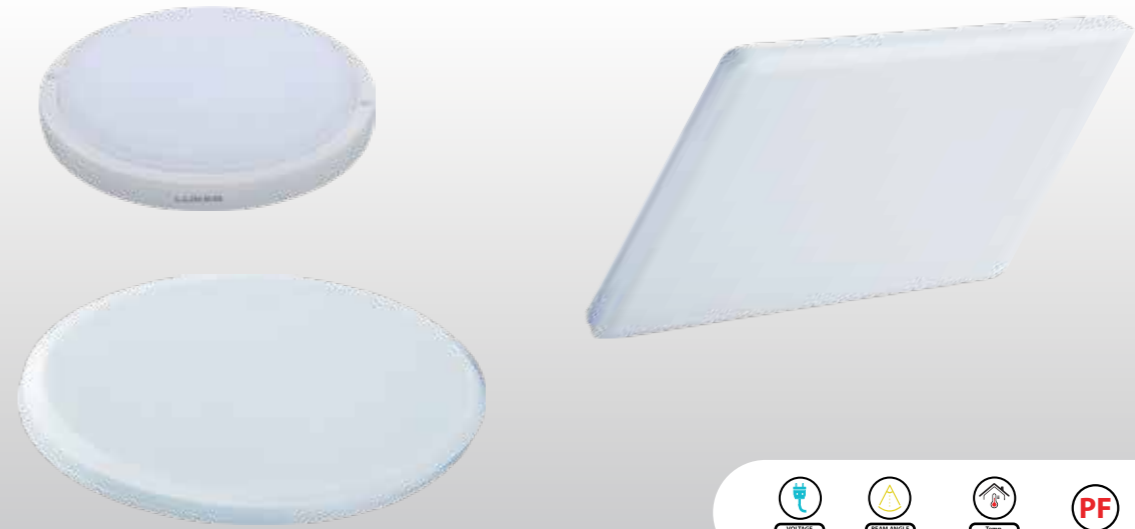

Product Code	Wattage	Voltage	Power Factor	System Luminous Efficacy	CRI	LED Light Source	Beam Angle	CCT	IP Rating	Surge Voltage	THD
<b>LBKRDSL10</b>	10W	230V	>0.95	100 LM/W	>80	SMD	120°	WH	IP65	3 KV	<15%
<b>LOR65-20</b>	20W	230V	>0.95	100 LM/W	>80	SMD	120°	WH,WW	IP65	3 KV	<15%
<b>LOR65-30</b>	30W	230V	>0.95	100 LM/W	>80	SMD	120°	WH,WW	IP65	3 KV	<15%
<b>LOS65-20</b>	20W	230V	>0.95	100 LM/W	>80	SMD	120°	WH,WW	IP65	3 KV	<15%
<b>LOS65-30</b>	30W	230V	>0.95	100 LM/W	>80	SMD	120°	WH,WW	IP65	3 KV	<15%

PRODUCT CODE	DIA	HEIGHT
LBKRDSL10	154	57
LOR65-20	200	52
LOR65-30	280	52

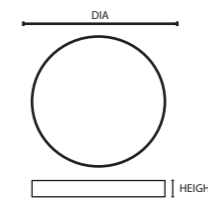

PRODUCT CODE	LENGTH	WIDTH	HEIGHT
LOS65-20	200	200	52
LOS65-30	280	280	52

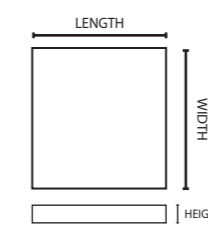

### Product Features

- Rated Life : 30000 Hrs
- Mounting Type : Surface Mounted
- Housing & Finish : ABS Plastic Body + PC Diffuser

### Applications

Houses, Hospitals, Showrooms, Parking area, Corridor

**IP65 LED SURFACE PANEL**





# LIVIANO LED SURFACE PANEL



# LIVIANO LED SURFACE PANEL

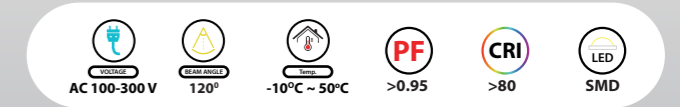
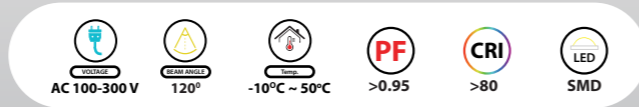

Product Code	Wattage	Voltage	Power Factor	System Luminous Efficacy	CRI	LED Light Source	Beam Angle	CCT	IP Rating	Surge Voltage	THD
LIPSR06	6W	230V	>0.95	100 LM/W	>80	SMD	120°	WH,WW NW	IP20	3 KV	<15%
LIPSR12	12W	230V	>0.95	100 LM/W	>80	SMD	120°	WH,WW NW	IP20	3 KV	<15%
LIPSR15	15W	230V	>0.95	100 LM/W	>80	SMD	120°	WH,WW NW	IP20	3 KV	<15%
LIPSR18	18W	230V	>0.95	100 LM/W	>80	SMD	120°	WH,WW NW	IP20	3 KV	<15%

Product Code	Wattage	Voltage	Power Factor	System Luminous Efficacy	CRI	LED Light Source	Beam Angle	CCT	IP Rating	Surge Voltage	THD
LIPSR06	6W	230V	>0.95	100 LM/W	>80	SMD	120°	WH,WW NW	IP20	3 KV	<15%
LIPSR12	12W	230V	>0.95	100 LM/W	>80	SMD	120°	WH,WW NW	IP20	3 KV	<15%
LIPSR15	15W	230V	>0.95	100 LM/W	>80	SMD	120°	WH,WW NW	IP20	3 KV	<15%
LIPSR18	18W	230V	>0.95	100 LM/W	>80	SMD	120°	WH,WW NW	IP20	3 KV	<15%

### Dimension (in mm)

PRODUCT CODE	LENGTH	WIDTH	HEIGHT
LIPSR06	120	120	29
LIPSR12	170	170	29
LIPSR15	170	170	29
LIPSR18	225	225	29

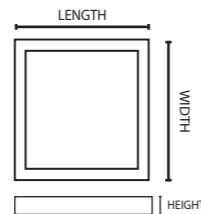

### Product Features

Rated Life : 30000 Hrs  
 Mounting Type : Surface Mounted  
 Housing & Finish : ABS Plastic Body + PC Diffuser

### Applications

Houses, Offices, Hospitals, Showrooms



PRODUCT CODE	DIA	HEIGHT
LIPSR06	120	29
LIPSR12	170	29
LIPSR15	170	29
LIPSR18	225	29

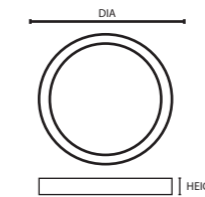

### Product Features

Rated Life : 30000 Hrs  
 Mounting Type : Surface Mounted  
 Housing & Finish : ABS Plastic Body + PC Diffuser

### Applications

Houses, Offices, Hospitals, Showrooms





**LIVIANO  
LED SLIM PANEL**



# LIVIANO LED SLIM PANEL



# LIVIANO LED SLIM PANEL

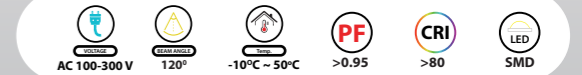
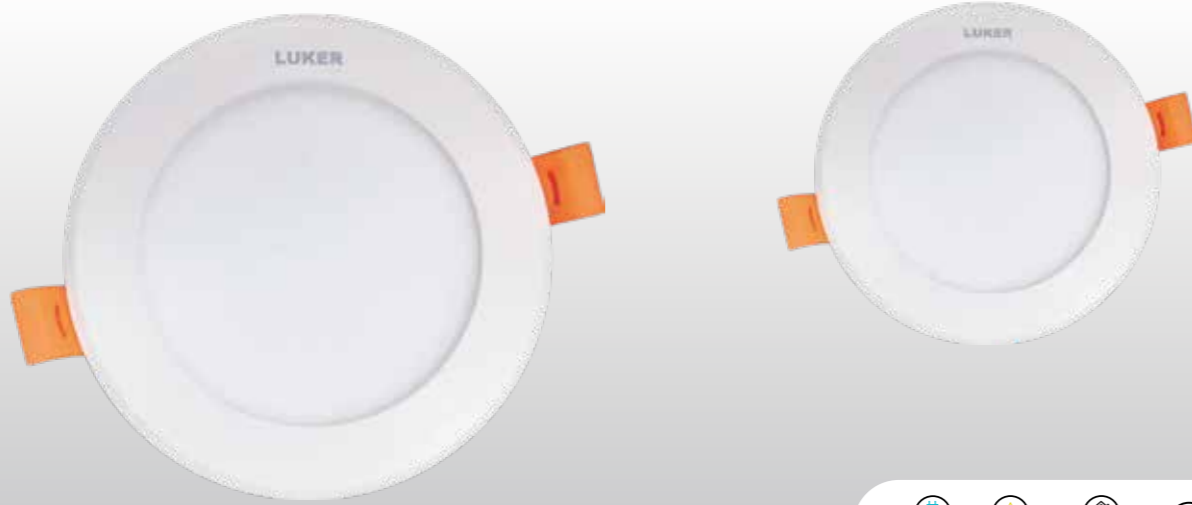

Product Code	Wattage	Voltage	Power Factor	System Luminous Efficacy	CRI	LED Light Source	Beam Angle	CCT	IP Rating	Surge Voltage	THD
LIPR03 N	3W	230V	>0.95	100 LM/W	>80	SMD	120°	WH,WW NW	IP20	3 KV	<15%
LIPR06 N	6W	230V	>0.95	100 LM/W	>80	SMD	120°	WH,WW NW	IP20	3 KV	<15%
LIPR12 N	12W	230V	>0.95	100 LM/W	>80	SMD	120°	WH,WW NW	IP20	3 KV	<15%
LIPR15 N	15W	230V	>0.95	100 LM/W	>80	SMD	120°	WH,WW NW	IP20	3 KV	<15%
LIPR18 N	18W	230V	>0.95	100 LM/W	>80	SMD	120°	WH,WW NW	IP20	3 KV	<15%

Product Code	Wattage	Voltage	Power Factor	System Luminous Efficacy	CRI	LED Light Source	Beam Angle	CCT	IP Rating	Surge Voltage	THD
LIPS03 N	3W	230V	>0.95	100 LM/W	>80	SMD	120°	WH,WW NW	IP20	3 KV	<15%
LIPS06 N	6W	230V	>0.95	100 LM/W	>80	SMD	120°	WH,WW NW	IP20	3 KV	<15%
LIPS12 N	12W	230V	>0.95	100 LM/W	>80	SMD	120°	WH,WW NW	IP20	3 KV	<15%
LIPS15 N	15W	230V	>0.95	100 LM/W	>80	SMD	120°	WH,WW NW	IP20	3 KV	<15%
LIPS18 N	18W	230V	>0.95	100 LM/W	>80	SMD	120°	WH,WW NW	IP20	3 KV	<15%

### Dimension (in mm)

PRODUCT CODE	DIA	HEIGHT	CUT-OUT
LIPR03 N	82	25	70
LIPR06 N	118	25	100
LIPR12 N	168	25	155
LIPR15 N	168	25	155
LIPR18 N	220	25	200

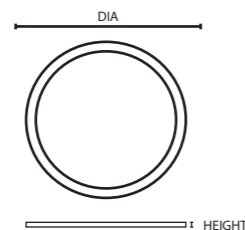

### Product Features

Rated Life : 30000 Hrs  
 Mounting Type : Recess Mounted  
 Housing & Finish : Die Cast Aluminium + PC Diffuser

### Applications

Houses, Offices, Hospitals, Showrooms

### Dimension (in mm)

PRODUCT CODE	LENGTH	WIDTH	HEIGHT	CUT-OUT
LIPS03 N	82	82	25	70 X 70
LIPS06 N	118	118	25	100 X 100
LIPS12 N	168	168	25	155 X 155
LIPS15 N	168	168	25	155 X 155
LIPS18 N	220	220	25	200 X 200

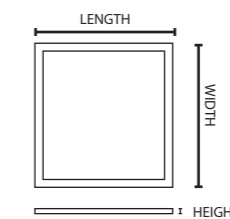

### Product Features

Rated Life : 30000 Hrs  
 Mounting Type : Recess Mounted  
 Housing & Finish : Die Cast Aluminium + PC Diffuser

### Applications

Houses, Offices, Hospitals, Showrooms



***LED DOWNLIGHTS***



# APTO ADJUSTABLE CUTOUT LED DOWNLIGHTS



# DURO JUNCTION BOX LED LIGHTS

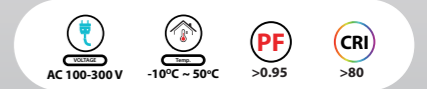
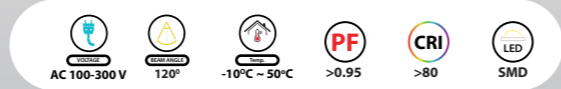
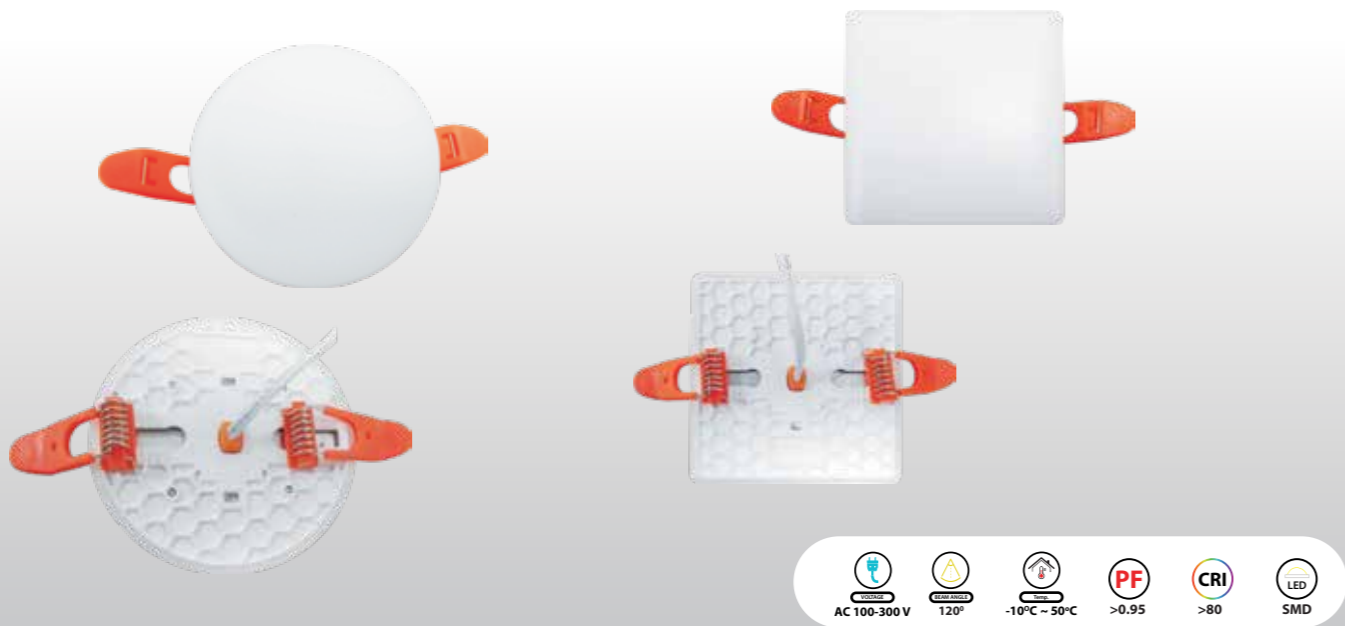

Product Code	Wattage	Voltage	Power Factor	System Luminous Efficacy	CRI	LED Light Source	Beam Angle	CCT	IP Rating	Surge Voltage	THD
<b>LDAR06</b>	6W	230V	>0.95	100 LM/W	>80	SMD	120°	WH,WW	IP20	3 KV	<15%
<b>LDAR12</b>	12W	230V	>0.95	100 LM/W	>80	SMD	120°	WH,WW	IP20	3 KV	<15%
<b>LDAS06</b>	6W	230V	>0.95	100 LM/W	>80	SMD	120°	WH,WW	IP20	3 KV	<15%
<b>LDAS12</b>	12W	230V	>0.95	100 LM/W	>80	SMD	120°	WH,WW	IP20	3 KV	<15%

Product Code	Wattage	Voltage	Power Factor	System Luminous Efficacy	CRI	LED Light Source	Beam Angle	CCT	IP Rating	Surge Voltage	THD
<b>LDRJB03N</b>	3W	230V	>0.95	100 LM/W	>80	SMD	120°	WH,WW	IP20	3 KV	<15%
<b>LDRJB03</b>	3W	230V	>0.95	100 LM/W	>80	COB	60°	WH,WW	IP20	3 KV	<15%
<b>LDRJBCOB03</b>	3W	230V	>0.95	100 LM/W	>80	COB	60°	WH,WW	IP20	3 KV	<15%
<b>LDR03</b>	3W	230V	>0.95	100 LM/W	>80	SMD	120°	WH,WW	IP20	3 KV	<15%
<b>LDR05</b>	5W	230V	>0.95	100 LM/W	>80	SMD	120°	WH,WW	IP20	3 KV	<15%

### Dimension (in mm)

PRODUCT CODE	DIA	HEIGHT	CUT-OUT
LDAR06	90	22	50-70
LDAR12	120	22	50-100

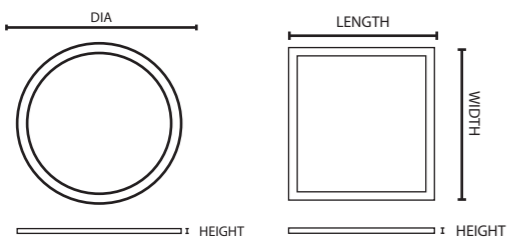

### Dimension (in mm)

PRODUCT CODE	LENGTH	WIDTH	HEIGHT	CUT-OUT
LDAS06	90	90	22	50-70
LDAS12	120	120	22	50-100

### Product Features

- Rated Life : 30000 Hrs
- Mounting Type : Recess Mounted
- Housing & Finish : Die Cast Aluminium + PC Diffuser

### Applications

Houses, Offices, Hospitals, Showrooms

### Dimension (in mm)

PRODUCT CODE	DIA	HEIGHT	CUT-OUT
LDRJB03N	80	20	38
LDRJB03	65	32	38
LDRJBCOB03	70	35	42
LDR03	70	35	45
LDR05	98	45	65

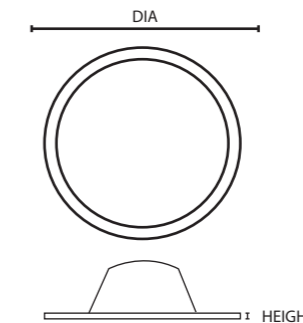

### Product Features

- Rated Life : 30000 Hrs
- Mounting Type : Recess Mounted
- Housing & Finish : Die Cast Aluminium + PC Diffuser

### Applications

Houses, Offices, Hospitals, Showrooms



**LED DOWNLIGHTS**



# DURO PVC BODY DOWNLIGHTS



# DURO METAL BODY DOWNLIGHTS

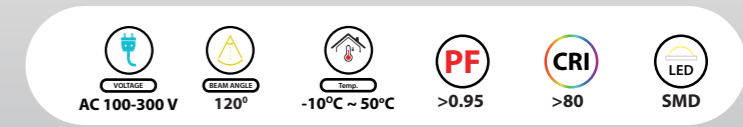
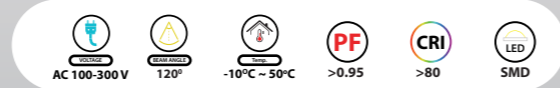

Product Code	Wattage	Voltage	Power Factor	System Luminous Efficacy	CRI	LED Light Source	Beam Angle	CCT	IP Rating	Surge Voltage	THD
LDR15	15W	230V	>0.95	100 LM/W	>80	SMD	120°	WW	IP20	4 KV	<15%
LDR20	20W	230V	>0.95	100 LM/W	>80	SMD	120°	WW	IP20	4 KV	<15%
LDS07	7W	230V	>0.95	100 LM/W	>80	SMD	120°	WH,WW NW	IP20	4 KV	<15%
LDS15	15W	230V	>0.95	100 LM/W	>80	SMD	120°	WH,WW NW	IP20	4 KV	<15%
LDS22	22W	230V	>0.95	100 LM/W	>80	SMD	120°	WW,NW	IP20	4 KV	<15%

### Dimension (in mm)

PRODUCT CODE	DIA	HEIGHT	CUT-OUT
LDR15	166	36	150
LDR20	220	36	205

PRODUCT CODE	LENGTH	WIDTH	HEIGHT	CUT-OUT
LDS07	116	116	36	100 x 100
LDS15	166	166	36	150 x 150
LDS22	220	220	36	205 x 205

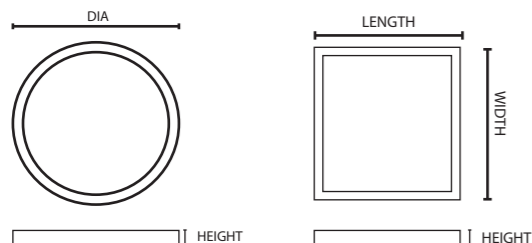

### Product Features

- Rated Life : 30000 Hrs
- Mounting Type : Recess Mounted
- Housing & Finish : Die Cast Aluminium + PC Diffuser

### Applications

Houses, Offices, Hospitals, Showrooms



Product Code	Wattage	Voltage	Power Factor	System Luminous Efficacy	CRI	LED Light Source	Beam Angle	CCT	IP Rating	Surge Voltage	THD
LDR07 MTL	7W	230V	>0.95	100 LM/W	>80	SMD	120°	WH	IP20	4 KV	<15%
LDR15 MTL	15W	230V	>0.95	100 LM/W	>80	SMD	120°	WH,WW NW	IP20	4 KV	<15%
LDR20 MTL	20W	230V	>0.95	100 LM/W	>80	SMD	120°	WH,WW NW	IP20	4 KV	<15%
LKM2236	36W	230V	>0.95	100 LM/W	>80	SMD	120°	WH	IP20	4 KV	<15%
LKM2240	40W	230V	>0.95	100 LM/W	>80	SMD	120°	WH,WW NW	IP20	4 KV	<15%
LKM2245	45W	230V	>0.95	100 LM/W	>80	SMD	120°	WH,WW	IP20	4 KV	<15%
LKM4145	45W	230V	>0.95	100 LM/W	>80	SMD	120°	WH,WW	IP20	4 KV	<15%

### Dimension (in mm)

PRODUCT CODE	LENGTH	WIDTH	HEIGHT	CUT-OUT
LKM2236	595	595	35	570 X 570
LKM2240	595	595	35	570 X 570
LKM2245	595	595	35	570 X 570
LKM4145	1195	295	35	1175 X 275

PRODUCT CODE	DIA	HEIGHT	CUT-OUT
LDR07 MTL	118	51	95
LDR15 MTL	170	32	135
LDR20 MTL	185	32	145

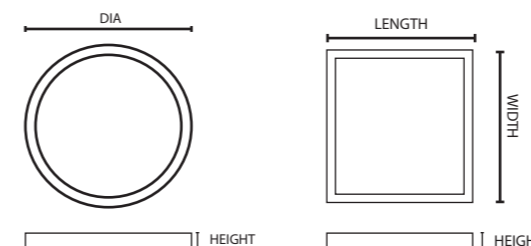

### Product Features

- Rated Life : 50000 Hrs
- Mounting Type : Recess Mounted
- Housing & Finish : Die Cast Aluminium + PC Diffuser

### Applications

Houses, Offices, Hospitals, Showrooms



# DURO BACKLIT LED SURFACE PANEL



Product Code	Wattage	Voltage	Power Factor	System Luminous Efficacy	CRI	LED Light Source	Beam Angle	CCT	IP Rating	Surge Voltage	THD
LKMSRS40N	40W	230V	>0.9	100 LM/W	>75	SMD	120°	WH,WW	IP20	1.5 KV	<15%
LKMSRS40	40W	230V	>0.95	100 LM/W	>80	SMD	120°	WH,WW	IP20	4 KV	<15%
LKMSRS45	45W	230V	>0.95	100 LM/W	>80	SMD	120°	WH,WW	IP20	4 KV	<15%
LKMSRS4145	45W	230V	>0.95	100 LM/W	>80	SMD	120°	WH,WW	IP20	4 KV	<15%

### Dimension (in mm)

PRODUCT CODE	LENGTH	WIDTH	HEIGHT
LKMSRS40N	595	595	40
LKMSRS40	595	595	65
LKMSRS45	595	595	65
LKMSRS4145	1200	300	35

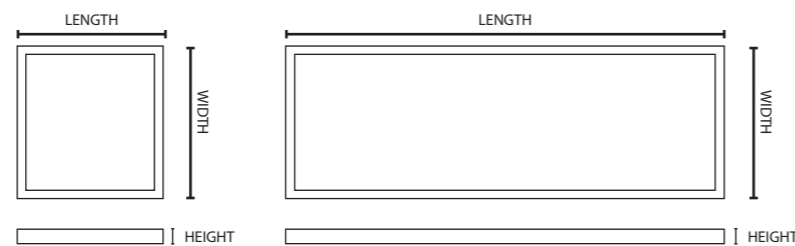

### Product Features

- Rated Life : 50000 Hrs
- Mounting Type : Surface Mounted
- Housing & Finish : Die Cast Aluminium + PC Diffuser

### Applications

Houses, Offices, Hospitals, Showrooms



# FUERA LED OUTDOOR DOWNLIGHTS

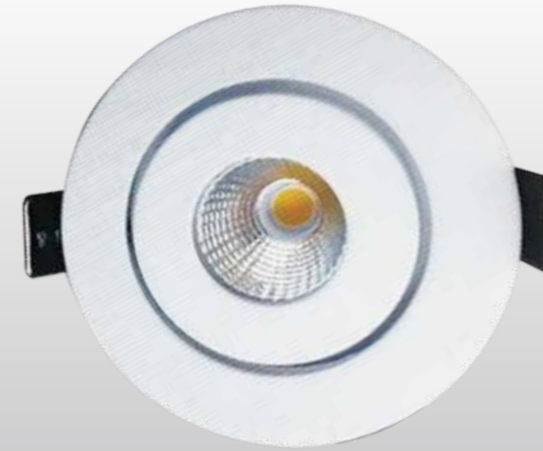

Product Code	Wattage	Voltage	Power Factor	System Luminous Efficacy	CRI	LED Light Source	Beam Angle	CCT	IP Rating	Surge Voltage	THD
LDR4405	5W	230V	>0.95	100 LM/W	>80	SMD	120°	WH,WW NW	IP54	3 KV	<15%
LCOB4405	5W	230V	>0.95	100 LM/W	>80	COB	60°	WH,WW NW	IP54	3 KV	<15%
LDR4412	12W	230V	>0.95	100 LM/W	>80	SMD	120°	WH,WW NW	IP54	3 KV	<15%

PRODUCT CODE	DIA	HEIGHT	CUT-OUT
LDR4405	88	26	90
LCOB4405	64	47	55
LDR4412	145	27	130

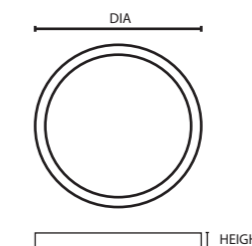

### Product Features

- Rated Life : 30000 Hrs
- Mounting Type : Recess Mounted
- Housing & Finish : Die Cast Aluminium + PC Diffuser

### Applications

Houses, Offices, Hospitals, Showrooms







**CORVUS  
LED COB DOWNLIGHTS**

# CORVUS CONCEALED COB/SPOT LED



# CORVUS CONCEALED COB/SPOT LED

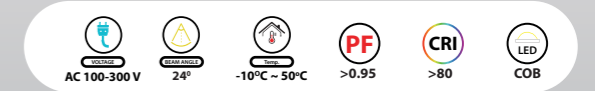

Product Code	Wattage	Voltage	Power Factor	System Luminous Efficacy	CRI	LED Light Source	Beam Angle	CCT	IP Rating	Surge Voltage	THD
LSCOB501	1W	230V	>0.95	90 LM/W	>80	COB	60°	WH,WW,NW	IP20	2 KV	<15%
LSCOBR01	1W	230V	>0.95	90 LM/W	>80	COB	60°	WH,WW,NW	IP20	2 KV	<15%
LSCR01	1W	230V	>0.95	90 LM/W	>80	COB	60°	WH,WW,NW, BL,RD,GR	IP20	2 KV	<15%
LSCS01	1W	230V	>0.95	90 LM/W	>80	COB	60°	WH,WW, BL,RD,GR	IP20	2 KV	<15%
LSCOBM01	1W	230V	>0.95	90 LM/W	>80	COB	60°	WH,WW	IP20	2 KV	<15%
LCOB03	3W	230V	>0.95	90 LM/W	>80	COB	60°	WH,WW	IP20	2 KV	<15%
LSCS03	3W	230V	>0.95	90 LM/W	>80	COB	60°	WH,WW,NW	IP20	2 KV	<15%
LSCR03	3W	230V	>0.95	90 LM/W	>80	COB	60°	WH,WW,NW	IP20	2 KV	<15%

### Dimension (in mm)

PRODUCT CODE	DIA	HEIGHT	CUT-OUT
LSCOBR01	32	14	25
LSCR01	32	15	25
LSCOBM01	42	18	34
LCOB03	40	23	28
LSCR03	50	25	35

PRODUCT CODE	LENGTH	WIDTH	HEIGHT	CUT-OUT
LSCOB501	30	30	15	25
LSCS01	31	31	21	27
LSCS03	50	50	25	35

### Product Features

Rated Life : 30000 Hrs  
 Mounting Type : Recess Mounted  
 Housing & Finish : Die Cast Aluminium + PC Diffuser

### Applications

Houses, Offices, Hospitals, Showrooms

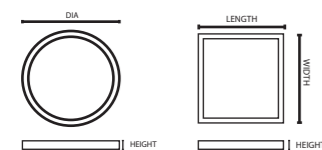

Product Code	Wattage	Voltage	Power Factor	System Luminous Efficacy	CRI	LED Light Source	Beam Angle	CCT	IP Rating	Surge Voltage	THD
LCOB04	4W	230V	>0.95	100 LM/W	>80	COB	24°	WH,WW,NW	IP20	4 KV	<15%
LCOBSN07	7W	230V	>0.95	100 LM/W	>80	COB	24°	WH,WW,NW	IP20	4 KV	<15%
LCOB12	12W	230V	>0.95	100 LM/W	>80	COB	24°	WH,WW,NW	IP20	4 KV	<15%
LCOB18	18W	230V	>0.95	100 LM/W	>80	COB	24°	WH,WW,NW	IP20	4 KV	<15%
LCOB30	30W	230V	>0.95	100 LM/W	>80	COB	24°	WH,WW,NW	IP20	4 KV	<15%

### Dimension (in mm)

PRODUCT CODE	DIA	HEIGHT	CUT-OUT
LCOB04	85	45	70
LCOBSN07	85	63	70
LCOB12	107	78	92
LCOB18	135	80	115
LCOB30	172	110	155

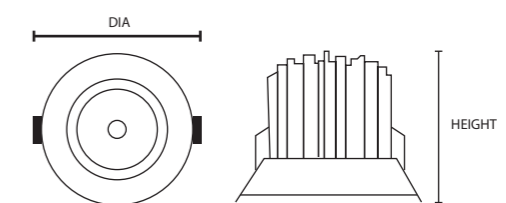

### Product Features

Rated Life : 50000 Hrs  
 Mounting Type : Recess Mounted  
 Housing & Finish : Die Cast Aluminium + PC Diffuser

### Applications

Houses, Offices, Hospitals, Showrooms





# CORVUS CONCEALED COB/SPOT LED

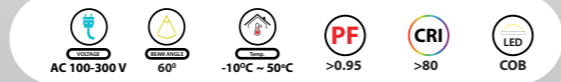

Product Code	Wattage	Voltage	Power Factor	System Luminous Efficacy	CRI	LED Light Source	Beam Angle	CCT	IP Rating	Surge Voltage	THD
LCOB07N	7W	230V	>0.95	100 LM/W	>80	COB	60°	WH,WW NW	IP20	4 KV	<15%
LCOB12N	12W	230V	>0.95	100 LM/W	>80	COB	60°	WH,WW NW	IP20	4 KV	<15%
LCOB18N	18W	230V	>0.95	100 LM/W	>80	COB	60°	WH,WW NW	IP20	4 KV	<15%
LCOB24N	24W	230V	>0.95	100 LM/W	>80	COB	60°	WH,WW NW	IP20	4 KV	<15%
LCOB30N	30W	230V	>0.95	100 LM/W	>80	COB	60°	WH,WW NW	IP20	4 KV	<15%
LCOB50N	50W	230V	>0.95	100 LM/W	>80	COB	60°	WH,WW NW	IP20	4 KV	<15%
LCOB18SQ	18W	230V	>0.95	100 LM/W	>80	COB	60°	WH,WW NW	IP20	4 KV	<15%
LCOB218SQ	2x18W	230V	>0.95	100 LM/W	>80	COB	60°	WH,WW NW	IP20	4 KV	<15%

### Dimension (in mm)

PRODUCT CODE	DIA	HEIGHT	CUT-OUT
LCOB07N	85	60	70
LCOB12N	108	69	92
LCOB18N	128	80	118
LCOB24N	136	88	113
LCOB30N	160	102	135
LCOB50N	170	120	140

PRODUCT CODE	LENGTH	WIDTH	HEIGHT	CUT-OUT
LSCOB18SQ	137	137	88	125X125
LCOB218SQ	250	137	88	235X125

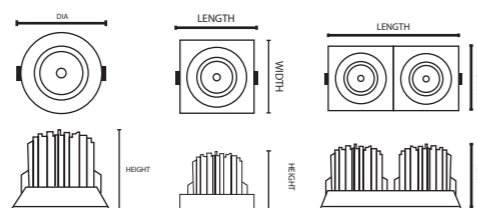

### Product Features

Rated Life : 50000 Hrs  
 Mounting Type : Recess Mounted  
 Housing & Finish : Die Cast Aluminium + PC Diffuser

### Applications

Houses, Offices, Hospitals, Showrooms



# CORVUS ANTI-GALRE LED



Product Code	Wattage	Voltage	Power Factor	System Luminous Efficacy	CRI	LED Light Source	Beam Angle	CCT	IP Rating	Surge Voltage	THD
LAGCOB07	7W	230V	>0.95	100 LM/W	>80	COB	20°	WH,WW NW	IP20	4 KV	<15%
LAGCOB12	12W	230V	>0.95	100 LM/W	>80	COB	25°	WH,WW NW	IP20	4 KV	<15%
LAGCOB18N	18W	230V	>0.95	100 LM/W	>80	COB	60°	WH,WW NW	IP20	4 KV	<15%
LAGCOB30	30W	230V	>0.95	100 LM/W	>80	COB	60°	WH,WW NW	IP20	4 KV	<15%

### Dimension (in mm)

PRODUCT CODE	DIA	HEIGHT	CUT-OUT
LAGCOB07	59	65	50
LAGCOB12	83	81	73
LAGCOB18N	90	88	80
LAGCOB30	119	120	108

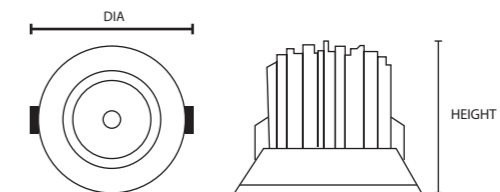

### Product Features

Rated Life : 50000 Hrs  
 Mounting Type : Recess Mounted  
 Housing & Finish : Die Cast Aluminium + PC Diffuser

### Applications

Houses, Offices, Hospitals, Showrooms



# CORVUS ANTI-GALRE LED



# CORVUS ANTI-GALRE LED

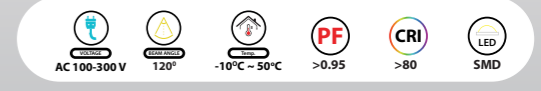
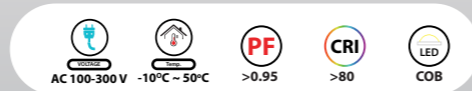

Product Code	Wattage	Voltage	Power Factor	System Luminous Efficacy	CRI	LED Light Source	Beam Angle	CCT	IP Rating	Surge Voltage	THD
<b>LAGRCOB07</b>	7W	230V	>0.95	100 LM/W	>80	COB	40°	WH,WW NW	IP20	4 KV	<15%
<b>LAGRCOB12</b>	12W	230V	>0.95	100 LM/W	>80	COB	38°	WH,WW NW	IP20	4 KV	<15%
<b>LAGCOB18</b>	18W	230V	>0.95	100 LM/W	>80	COB	60°	WH,WW NW	IP20	4 KV	<15%

### Dimension (in mm)

PRODUCT CODE	DIA	HEIGHT	CUT-OUT
LAGRCOB07	59	65	50
LAGRCOB12	83	81	73
LAGCOB18N	95	96	85

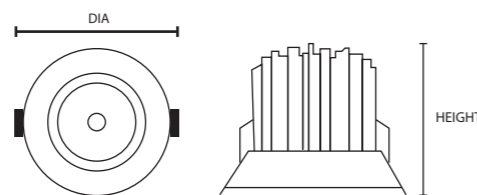

### Product Features

- Rated Life : 50000 Hrs
- Mounting Type : Recess Mounted
- Housing & Finish : Die Cast Aluminium + Chrome Reflector

### Applications

Houses, Offices, Hospitals, Showrooms



Product Code	Wattage	Voltage	Power Factor	System Luminous Efficacy	CRI	LED Light Source	Beam Angle	CCT	IP Rating	Surge Voltage	THD
--------------	---------	---------	--------------	--------------------------	-----	------------------	------------	-----	-----------	---------------	-----

### BLACK BODY

<b>LCOB03BK</b>	3W	230V	>0.95	100 LM/W	>80	COB	38°	WH,WW NW	IP20	4 KV	<15%
<b>LAGBCOB12BK</b>	12W	230V	>0.95	100 LM/W	>80	COB	38°	WH,WW NW	IP20	4 KV	<15%

### BLACK BODY WITH ROSE GOLD REFLECTOR

<b>LCOB03RG</b>	3W	230V	>0.95	100 LM/W	>80	COB	38°	WW,NW	IP20	4 KV	<15%
<b>LAGBCOB12</b>	12W	230V	>0.95	100 LM/W	>80	COB	38°	WH,WW NW	IP20	4 KV	<15%

### Dimension (in mm)

PRODUCT CODE	DIA	HEIGHT	CUT-OUT
LCOB03BK	37	32	27
LAGBCOB12BK	83	78	71
LCOB03RG	37	32	27
LAGBCOB12	83	81	73

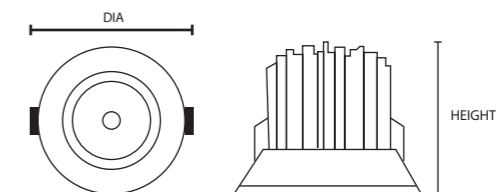

### Product Features

- Rated Life : 50000 Hrs
- Mounting Type : Recess Mounted
- Housing & Finish : Die Cast Aluminium

### Applications

Houses, Offices, Hospitals, Showrooms





# CORVUS LINEAR LED COB LIGHTS



# CORVUS SURFACE LED COB LIGHTS

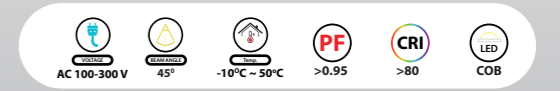

Product Code	Wattage	Voltage	Power Factor	System Luminous Efficacy	CRI	LED Light Source	Beam Angle	CCT	IP Rating	Surge Voltage	THD
LCOB106SQ	6W	230V	>0.95	100 LM/W	>80	COB	45°	WH,WW NW	IP20	4 KV	<15%
LCOB306SQ	18W	230V	>0.95	100 LM/W	>80	COB	45°	WH,WW NW	IP20	4 KV	<15%
LCOB506SQ	30W	230V	>0.95	100 LM/W	>80	COB	45°	WH,WW NW	IP20	4 KV	<15%

### Dimension (in mm)

PRODUCT CODE	LENGTH	WIDTH	HEIGHT	CUT-OUT
LCOB106SQ	65	65	45	55X55
LCOB306SQ	165	65	45	146X55
LCOB506SQ	250	62.5	49	240X55

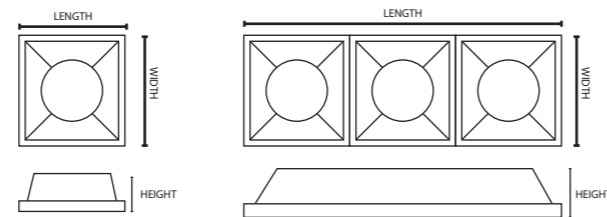

### Product Features

- Rated Life : 50000 Hrs
- Mounting Type : Recess Mounted
- Housing & Finish : Die Cast Aluminium + PC Lens Diffuser

### Applications

Houses, Offices, Hospitals, Showrooms

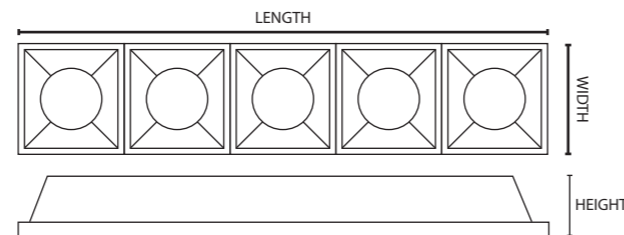

Product Code	Wattage	Voltage	Power Factor	System Luminous Efficacy	CRI	LED Light Source	Beam Angle	CCT	IP Rating	Surge Voltage	THD
LCOBSRR12	12W	230V	>0.95	100 LM/W	>80	COB	45°	WH,WW NW	IP20	4 KV	<15%
LCOBSRR12	12W	230V	>0.95	100 LM/W	>80	COB	45°	WH,WW NW	IP20	4 KV	<15%
LCOBSRS12	12W	230V	>0.95	100 LM/W	>80	COB	45°	WH,WW NW	IP20	4 KV	<15%
LCOBSRS12	12W	230V	>0.95	100 LM/W	>80	COB	45°	WH,WW NW	IP20	4 KV	<15%
LCOBSRR18	18W	230V	>0.95	100 LM/W	>80	COB	45°	WH,WW NW	IP20	4 KV	<15%
LCOBSRR18	18W	230V	>0.95	100 LM/W	>80	COB	45°	WH,WW NW	IP20	4 KV	<15%
LCOBSRR30	30W	230V	>0.95	100 LM/W	>80	COB	45°	WH,WW NW	IP20	4 KV	<15%
LCOBSRR30	30W	230V	>0.95	100 LM/W	>80	COB	45°	WH,WW NW	IP20	4 KV	<15%

### Dimension (in mm)

PRODUCT CODE	DIA	HEIGHT
LCOBSRR12	76	100
LCOBSRR12	76	100
LCOBSRR18	93	120
LCOBSRR18	93	120
LCOBSRR30	115	130
LCOBSRR30	115	130

### Dimension (in mm)

PRODUCT CODE	LENGTH	WIDTH	HEIGHT
LCOBSRS12	74	74	90
LCOBSRS12	74	74	90

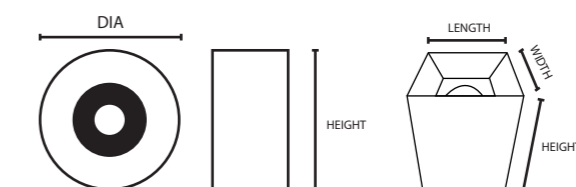

### Product Features

- Rated Life : 30000 Hrs
- Mounting Type : Recess Mounted
- Housing : Die Cast Aluminium + Chrome Reflector
- Finish : Black body & White body

### Applications

Houses, Offices, Hospitals, Showrooms



# CORVUS HANGING/OUTDOOR SURFACE



# CORVUS DIMMABLE LED COB LIGHTS



Product Code	Wattage	Voltage	Power Factor	System Luminous Efficacy	CRI	LED Light Source	Beam Angle	CCT	IP Rating	Surge Voltage	THD
<b>HANGING LED COB LIGHTS</b>											
LCOBHL12	12W	230V	>0.95	100 LM/W	>80	COB	60°	WH,WW NW	IP20	3 KV	<15%
LCOBBHL12	12W	230V	>0.95	100 LM/W	>80	COB	60°	WH,WW NW	IP20	3 KV	<15%
<b>OUTDOOR SURFACE LED COB LIGHTS (IP54)</b>											
LCOBSRR5406	6W	230V	>0.95	100 LM/W	>80	COB	40°	WW	IP54	3 KV	<15%
LCOBSRR5405	5W	230V	>0.95	100 LM/W	>80	COB	40°	WW	IP54	3 KV	<15%

### Dimension (in mm)

PRODUCT CODE	DIA	HEIGHT
LCOBHL12	80	220
LCOBBHL12	80	220
LCOBSRR5406	53	59
LCOBSRR5405	58	17

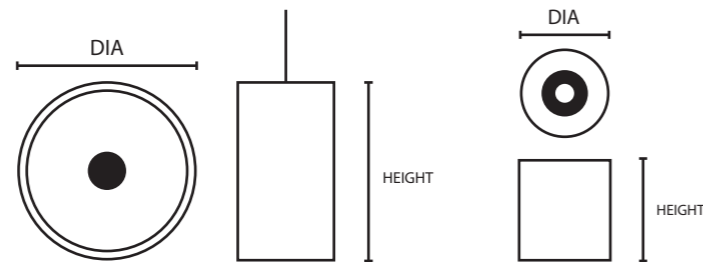

HANGING LIGHT

SURFACE LIGHT

### Product Features

- Rated Life : 50000 Hrs
- Mounting Type : Hanging/Surface
- Housing & Finish : Die Cast Aluminium

### Applications

Houses, Offices, Hospitals, Showrooms



Product Code	Wattage	Voltage	Power Factor	System Luminous Efficacy	CRI	LED Light Source	Beam Angle	CCT	IP Rating	Surge Voltage	THD
LCOBD07	7W	230V	>0.95	100 LM/W	>80	COB	60°	WH,WW NW	IP20	4 KV	<15%
LCOBD12	12W	230V	>0.95	100 LM/W	>80	COB	60°	WH,WW NW	IP20	4 KV	<15%
LCOBD18	18W	230V	>0.95	100 LM/W	>80	COB	60°	WH,WW NW	IP20	4 KV	<15%
LCOBD24	24W	230V	>0.95	100 LM/W	>80	COB	60°	WH,WW NW	IP20	4 KV	<15%
LCOBD30	30W	230V	>0.95	100 LM/W	>80	COB	60°	WH,WW NW	IP20	4 KV	<15%

### Dimension (in mm)

PRODUCT CODE	DIA	HEIGHT	CUT-OUT
LCOBD07	85	63	70
LCOBD12	107	78	92
LCOBD18	135	80	115
LCOBD24	136	88	116
LCOBD30	160	98	140

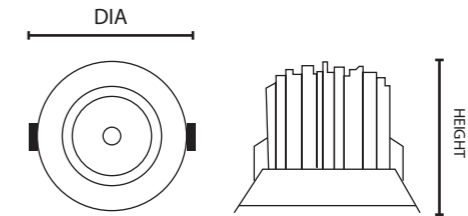

### Product Features

- Rated Life : 50000 Hrs
- Mounting Type : Recess Mounted
- Housing & Finish : Die Cast Aluminium + Glass Diffuser
- Dimmable Function : LUKER Dimmable LEDs work with TRAIC Dimmers. They May be some restriction in terms of dimming functionality when used with other lighting dimmers

### Applications

Houses, Offices, Hospitals, Showrooms





# CORVUS DEEP LED COB LIGHTS

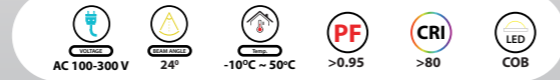

# DOMO CEILING LED LIGHTS

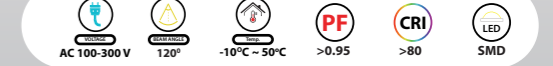

Product Code	Wattage	Voltage	Power Factor	System Luminous Efficacy	CRI	LED Light Source	Beam Angle	CCT	IP Rating	Surge Voltage	THD
LCOBPH12	12W	230V	>0.95	100 LM/W	>80	COB	24°	WH,WW NW	IP20	4 KV	<15%
LCOBHC12	12W	230V	>0.95	100 LM/W	>80	COB	24°	WH,WW NW	IP20	4 KV	<15%
LCOB12SQ	12W	230V	>0.95	100 LM/W	>80	COB	24°	WH,WW NW	IP20	4 KV	<15%
LCOB212SQ	24W	230V	>0.95	100 LM/W	>80	COB	24°	WH,WW NW	IP20	4 KV	<15%

### Dimension (in mm)

PRODUCT CODE	DIA	HEIGHT	CUT-OUT
LCOBPH12	88	100	73
LCOBHC12	88	110	70

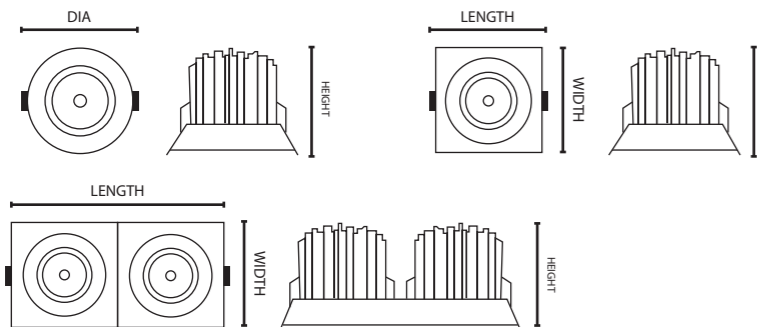

### Dimension (in mm)

PRODUCT CODE	LENGTH	WIDTH	HEIGHT	CUT-OUT
LCOB12SQ	92	92	85	80X80
LCOB212SQ	172	92	85	155X80

### Product Features

- Rated Life : 50000 Hrs
- Mounting Type : Recess Mounted
- Housing & Finish : Die Cast Aluminium

### Applications

Houses, Offices, Hospitals, Showrooms



Product Code	Wattage	Voltage	Power Factor	System Luminous Efficacy	CRI	LED Light Source	Beam Angle	CCT	IP Rating	Surge Voltage	THD
LCL18S	18W	230V	>0.95	100 LM/W	>80	SMD	120°	WH,WW	IP20	3 KV	<15%
LCL18R	18W	230V	>0.95	100 LM/W	>80	SMD	120°	WH,WW	IP20	3 KV	<15%
LCL07R	7W	230V	>0.95	100 LM/W	>80	SMD	120°	WH,WW	IP20	3 KV	<15%

### Dimension (in mm)

PRODUCT CODE	DIA	HEIGHT
LCL18R	320	80
LCL07R	85	51

### Dimension (in mm)

PRODUCT CODE	LENGTH	WIDTH	HEIGHT
LCL18S	270	270	60

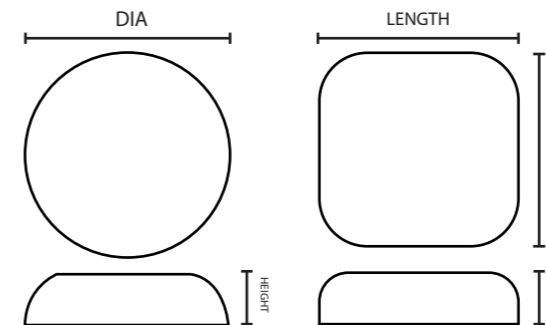

### Product Features

- Rated Life : 30000 Hrs
- Mounting Type : Surface Mounted
- Housing & Finish : Polycarbonate body & Diffuser

### Applications

Houses, Offices, Hospitals, Showrooms







**FERMO**  
FOCUS LED LIGHT



# FERMO FOCUS LED LIGHT



# FERMO FOCUS LED LIGHT

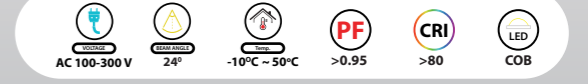
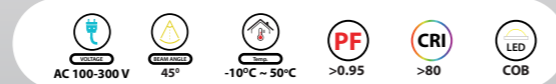

Product Code	Wattage	Voltage	Power Factor	System Luminous Efficacy	CRI	Body Finish	Beam Angle	CCT	IP Rating	Surge Voltage	THD
LSP01 SL	1W	230V	>0.95	100 LM/W	>80	SILVER	45°	WH,WW NW	IP20	3 KV	<15%
LSP01 BK	1W	230V	>0.95	100 LM/W	>80	BLACK	45°	WH,WW NW	IP20	3 KV	<15%
LSP02 SL	1W	230V	>0.95	100 LM/W	>80	SILVER	45°	WH,WW	IP20	3 KV	<15%
LSP02 PKW	1W	230V	>0.95	100 LM/W	>80	WHITE	45°	WH,WW	IP20	3 KV	<15%
LSP04	3W	230V	>0.95	100 LM/W	>80	WHITE	45°	WH,WW	IP20	3 KV	<15%
LSP04 BK	3W	230V	>0.95	100 LM/W	>80	BLACK	45°	WH,WW	IP20	3 KV	<15%

### Dimension (in mm)

PRODUCT CODE	DIA	HEIGHT
LSP01 SL	48	91
LSP01 BK	48	91
LSP02 SL	48	88
LSP02 PKW	48	88
LSP04	63	196
LSP04 BK	63	196

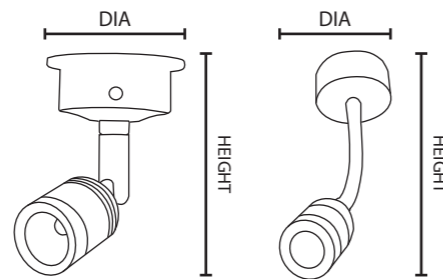

### Applications

Houses, Offices, Hospitals, Showrooms

### Product Features

- Rated Life : 30000 Hrs
- Mounting Type : Surface Mounted
- Housing : Die Cast Aluminium
- Light Source Rotation : 360° Rotation

Product Code	Wattage	Voltage	Power Factor	System Luminous Efficacy	CRI	LED Light Source	Beam Angle	CCT	IP Rating	Surge Voltage	THD
LSP03	3W	230V	>0.95	100 LM/W	>80	COB	24°	WH,WW	IP20	3 KV	<15%
LSP07	7W	230V	>0.95	100 LM/W	>80	COB	24°	WH,WW	IP20	3 KV	<15%
LSP18	18W	230V	>0.95	100 LM/W	>80	COB	24°	WH,WW	IP20	3 KV	<15%

### Dimension (in mm)

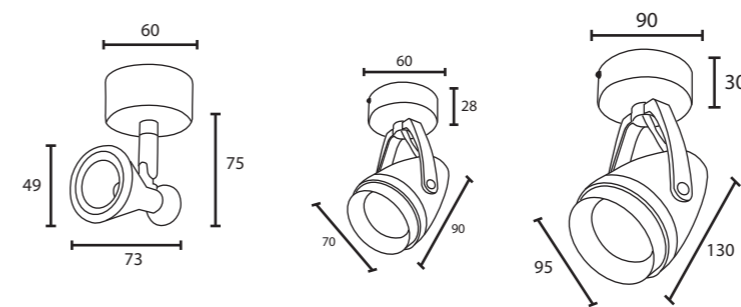

### Product Features

- Rated Life : 30000 Hrs
- Mounting Type : Surface Mounted
- Housing : Die Cast Aluminium
- Light Source Rotation : 360° Rotation

### Applications

Houses, Offices, Hospitals, Showrooms





# FISSO

ZOOM LED LIGHT

# FISSO ZOOM LED LIGHT

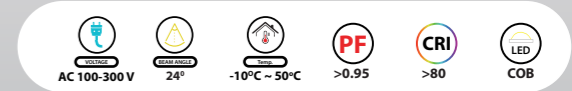

Product Code	Wattage	Voltage	Power Factor	System Luminous Efficacy	CRI	LED Light Source	Beam Angle	CCT	IP Rating	Surge Voltage	THD
LZCOB07	7W	230V	>0.95	100 LM/W	>80	COB	24°	WH,WW NW	IP20	4 KV	<15%
LZCOB18	18W	230V	>0.95	100 LM/W	>80	COB	24°	WH,WW NW	IP20	4 KV	<15%
LZCOB35	35W	230V	>0.95	100 LM/W	>80	COB	24°	WH,WW NW	IP20	4 KV	<15%
LZCOB50	50W	230V	>0.95	100 LM/W	>80	COB	24°	WH,WW NW	IP20	4 KV	<15%
LZCOB50SQ	50W	230V	>0.95	100 LM/W	>80	COB	24°	WH,WW NW	IP20	4 KV	<15%
LAZCOB12	12W	230V	>0.95	100 LM/W	>80	COB	24°	WH,WW NW	IP20	4 KV	<15%

### Dimension (in mm)

PRODUCT CODE	DIA	HEIGHT	CUT-OUT
LZCOB07	89	55	80
LZCOB18	134	128	112
LZCOB35	155	120	148
LZCOB50	200	150	180
LZCOB12	100	183	135

PRODUCT CODE	LENGTH	WIDTH	HEIGHT	CUT-OUT
LZCOB50SQ	240	145	100	207x122

### Product Features

Rated Life : 30000 Hrs  
 Mounting Type : Surface Mounted  
 Housing : Die Cast Aluminium

### Applications

Houses, Offices, Hospitals, Showrooms







# FUOCO TRACK LED LIGHTS

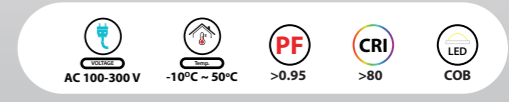

Product Code	Wattage	Voltage	Power Factor	System Luminous Efficacy	CRI	LED Light Source	Beam Angle	CCT	IP Rating	Surge Voltage	THD
<b>LSPT12</b>	12W	230V	>0.95	100 LM/W	>80	COB	60°	WH,WW NW	IP20	4 KV	<15%
<b>LSPT12S</b>	12W	230V	>0.95	100 LM/W	>80	COB	36°	WH,WW NW	IP20	4 KV	<15%
<b>LSPT18</b>	18W	230V	>0.95	100 LM/W	>80	COB	60°	WH,WW NW	IP20	4 KV	<15%
<b>LSPT18S</b>	18W	230V	>0.95	100 LM/W	>80	COB	36°	WH,WW NW	IP20	4 KV	<15%
<b>LSPT24</b>	24W	230V	>0.95	100 LM/W	>80	COB	60°	WH,WW NW	IP20	4 KV	<15%
<b>LSPT24S</b>	24W	230V	>0.95	100 LM/W	>80	COB	36°	WH,WW NW	IP20	4 KV	<15%
<b>LSPT30</b>	30W	230V	>0.95	100 LM/W	>80	COB	60°	WH,WW NW	IP20	4 KV	<15%
<b>LSPT30S</b>	30W	230V	>0.95	100 LM/W	>80	COB	45°	WH,WW NW	IP20	4 KV	<15%

### Dimension (in mm)

PRODUCT CODE	A	B	C	D	E
LSPT12	95	40	96	60	100
LSPT12S	120.5	34.9	98	75.5M	97.5
LSPT18	126	42	121	69.7	24
LSPT18S	120	35	133.2	90	96.8
LSPT24	185	34.5	140	90	105
LSPT24S	120.5	34.7	134	90	95
LSPT30	148.5	47	148.5	79.46	107.7
LSPT30S	120	34.6	149.5	98	97

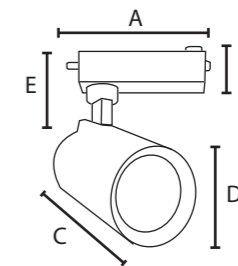

### Product Features

- Rated Life : 30000 Hrs
- Mounting Type : Track Mounted
- Housing : Die Cast Aluminium
- Body finish : Black & White Body
- Light Source Rotation : 360° Rotation

### Applications

Houses, Offices, Hospitals, Showrooms

# FUOCO TRACK LED LIGHTS





# FUOCO MAGNETIC LED TRACK LIGHTS

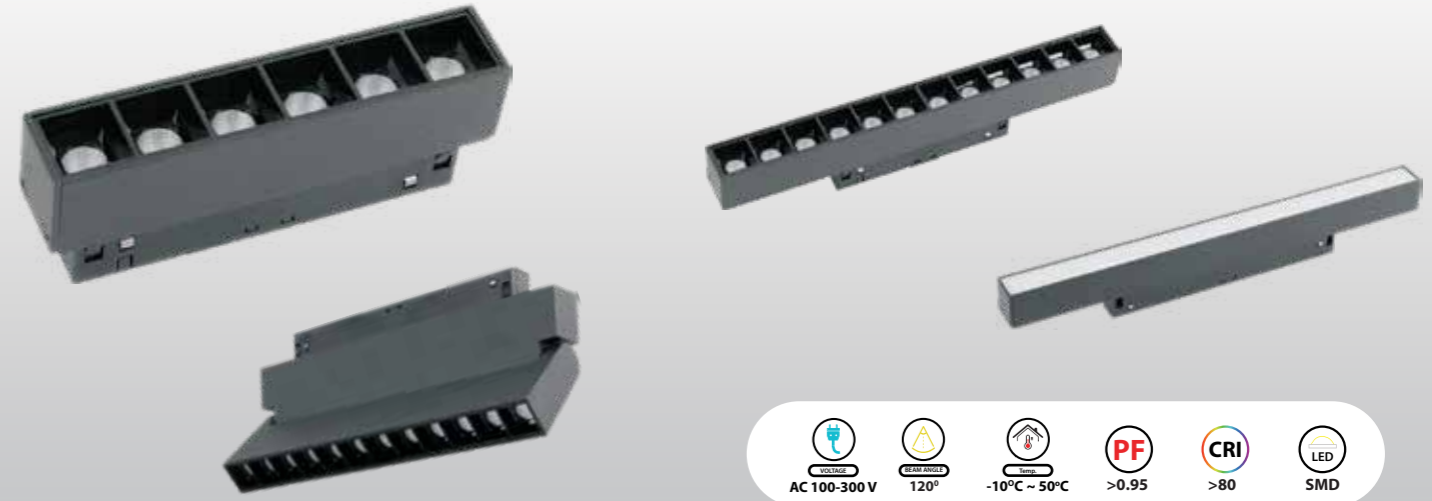

Product Code	Wattage	Voltage	Power Factor	System Luminous Efficacy	CRI	LED Light Source	Beam Angle	CCT	IP Rating	Surge Voltage	THD
<b>LMTLN06</b>	6W	230V	>0.95	100 LM/W	>80	SMD	60°	WW, NW	IP20	4 KV	<15%
<b>LMTLN18</b>	18W	230V	>0.95	100 LM/W	>80	SMD	60°	WW, NW	IP20	4 KV	<15%
<b>LMTLN12A</b>	12W	230V	>0.95	100 LM/W	>80	SMD	60°	WW, NW	IP20	4 KV	<15%
<b>LMTLN20</b>	20W	230V	>0.95	100 LM/W	>80	SMD	60°	WW, NW	IP20	4 KV	<15%

### Dimension (in mm)

PRODUCT CODE	LENGTH	WIDTH	HEIGHT
LMTLN06	108	22	25
LMTLN18	322	22	25
LMTLN12A	220	22	115
LMTLN20	600	22	25

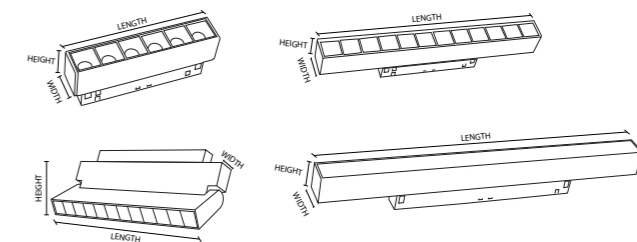

### Product Features

- Rated Life : 30000 Hrs
- Mounting Type : Track Mounted
- Housing & Finish : ABS Plastic Body + PC Diffuser

### Applications

Houses, Showrooms, Hotels, Resorts, Corridor

# FUOCO

MAGNETIC LED TRACK LIGHTS





# FUOCO MAGNETIC LED TRACK LIGHTS

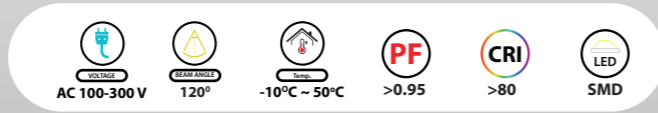

# FUOCO MAGNETIC TRACK ACCESSORIES



Product Code	Wattage	Voltage	Power Factor	System Luminous Efficacy	CRI	LED Light Source	Beam Angle	CCT	IP Rating	Surge Voltage	THD
LMTSP20	20W	230V	>0.95	100 LM/W	>80	SMD	60°	WW, NW	IP20	3 KV	<15%
LMTSP09	20W	230V	>0.95	100 LM/W	>80	SMD	60°	WW, NW	IP20	3 KV	<15%

### Dimension (in mm)

PRODUCT CODE	DIA	HEIGHT
LMTSP20	58	155
LMTSP09	95	34

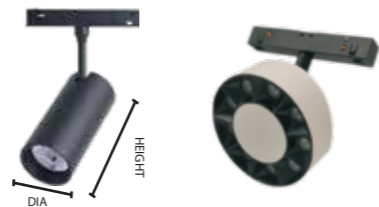

### Product Features

- Rated Life : 30000 Hrs
- Mounting Type : Track Mounted
- Housing & Finish : ABS Plastic Body + PC Diffuser

### Applications

Houses, Showrooms, Hotels, Resorts, Corridor



### Surface Track Channel - 1 MTR

MODEL	DIMENSION (IN MM)	BODY COLOR
LMTCH1MBK	1000(L) X 26.5(W) X 53.5 (H)	BLACK

### Surface Track Channel - 2 MTR

MODEL	DIMENSION (IN MM)	BODY COLOR
LMTCH2MBK	2000(L) X 26.5(W) X 53.5 (H)	BLACK

### Concealed Track Channel - 2 MTR

MODEL	DIMENSION (IN MM)	BODY COLOR
LMTCHRC2MBK	2000(L) X 70(W) X 53.5 (H)	BLACK

### Surface Track Fixing Clamp

MODEL	DIMENSION (IN MM)	BODY COLOR
LMTCL	-	-

### Wire connector - START

MODEL	DIMENSION (IN MM)	BODY COLOR
LMTHCNC	-	BLACK

### Wire connector - STRAIGHT

MODEL	DIMENSION (IN MM)	BODY COLOR
LMTICNC	-	BLACK

### Wire connector - CORNER

MODEL	DIMENSION (IN MM)	BODY COLOR
LMTH4CNC	-	BLACK

### HORIZONTAL SURFACE - CORNER

MODEL	DIMENSION (IN MM)	BODY COLOR
LMTHCR	1000(L) X 26.5(W) X 53.5 (H)	BLACK

### VERTICAL SURFACE - CORNER

MODEL	DIMENSION (IN MM)	BODY COLOR
LMTCH1MBK	80X80	BLACK

### MAGNETIC LED DRIVER 100W, 48V

MODEL	DIMENSION (IN MM)	BODY COLOR
LMTDR100	220(L) X 23(W) X 26 (H)	BLACK

### MAGNETIC LED DRIVER 200W, 48V

MODEL	DIMENSION (IN MM)	BODY COLOR
LMTDR200	310(L) X 23(W) X 26 (H)	BLACK





***LED STRIP - INDOOR***





# LED STRIP - INDOOR

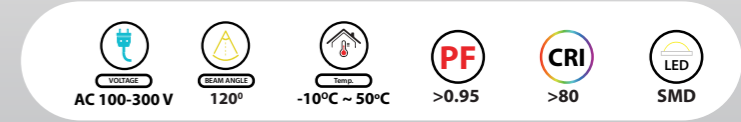
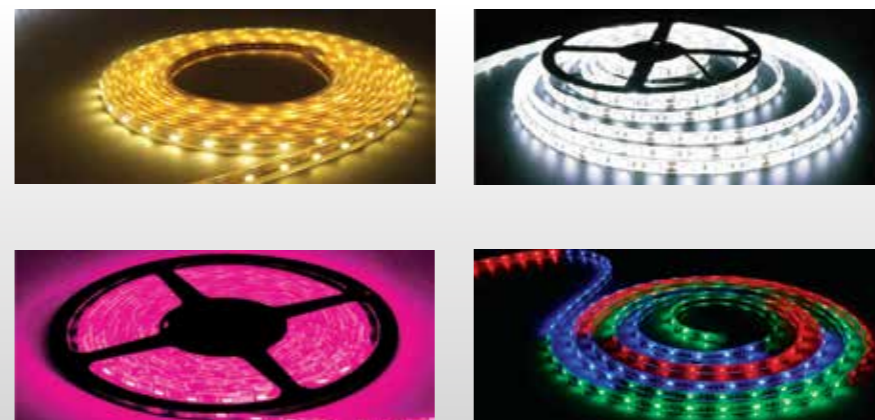

Product Code	Wattage	Voltage	LED's/ Meter	System Luminous Efficacy	CRI	LED Light Source	Beam Angle	CCT	IP Rating	LED Size	STD PKG.
<b>VERO INDOOR STRIP-2835</b>											
<b>LS2835</b>	6W	12V	60	60-70 LM/M	>80	SMD	120°	WH,WW NW,BL,RD,GR	IP20	2835	5M/POLL
<b>LSI2835</b>	6W	12V	60	60-70 LM/M	>80	SMD	120°	PINK	IP20	2835	<15%
<b>LORO INDOOR STRIP-5050</b>											
<b>LS5050</b>	14.6W	230V	60	60-70 LM/M	>80	SMD	120°	WH,WW NW,BL,RD,GR	IP20	5050	<15%
<b>LSI5050</b>	14.6W	230V	60	60-70 LM/M	>80	SMD	120°	PINK / RGB	IP20	5050	<15%

### Dimension (in mm)

PRODUCT CODE	LENGTH	WIDTH	HEIGHT
LS2835	5MTR	7.7MM	1MM
LSI2835	5MTR	6.7MM	1MM
LS5050	5MTR	10.1MM	1MM
LSI5050	5MTR	9.5MM	1MM

### Product Features

Rated Life : 30000 Hrs  
 Mounting Type : Surface mount  
 Housing & Finish : Flexible LED PCB

### Applications

Houses, Hotels, Restaurants, Resort, Showrooms

# LED STRIP - INDOOR







# CAPO OUTDOOR LED STRIP- IP65

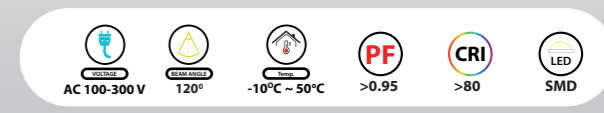
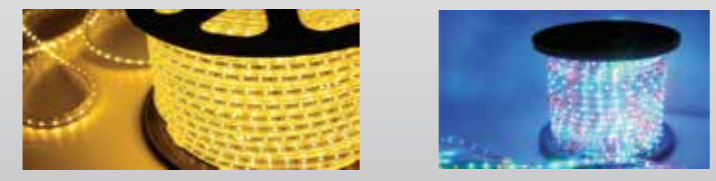

Product Code	Watts/Meter	Voltage	LED'S/ Meter	System Luminous Efficacy	CRI	LED Light Source	Beam Angle	CCT	IP Rating	LED Size	STD PKG.
<b>LS02835220V</b>	8W	220V	120	60-70 LM/W	>80	SMD	120°	WH,WW,NW, RD,BL,GR,PK	IP65	2835	50Mtr
<b>LS05050</b>	14.4W	220V	60	60-70 LM/W	>80	SMD	120°	WH,WW, RD,BL,GR	IP65	5050	50Mtr
<b>LS05050</b>	14.4W	220V	60	60-70 LM/W	>80	SMD	120°	RGB,PINK	IP65	5050	50Mtr
<b>LS054</b>	6W	24V	120	60-70 LM/W	>80	SMD	120°	WH,WW	IP65	2835	50Mtr
<b>LS068</b>	12W	24V	120	60-70 LM/W	>80	SMD	120°	WW	IP65	2835	50Mtr

### Dimension

PRODUCT CODE	LENGTH	WIDTH	HEIGHT
LS02835220V	50MTR	10.2MM	5.6MM
LS05050	50MTR	20.2MM	5.6MM
LS05050	50MTR	16.8MM	7.15MM
LS054	50MTR	16MM	7MM
LS068	10MTR	9.2MM	4.4MM

### Product Features

Rated Life : 30000 Hrs  
 Mounting Type : Surface mount  
 Housing & Finish : Flexible LED PCB

### Applications

Houses, Hotels, Restaurants, Resort, Showrooms

# CAPO OUTDOOR LED STRIP- IP65





# NERO NEON FLEXIBLE STRIP - OUTDOOR



## STRIP LIGHT ACCESSORIES



Product Code	Watts/METER	Voltage	LED'S/Meter	System Luminous Efficacy	CRI	LED Light Source	Beam Angle	CCT	IP Rating	LED SIZE	STD PKG
<b>LS02835</b>	12W	220V	120	60-70 LM/W	>80	SMD	120°	WH,WW NW,BL	IP65	2835	50Mtr
<b>LS02835</b>	12W	220V	120	60-70 LM/W	>80	SMD	120°	RD,GR, PINK	IP65	2835	50Mtr
<b>LS0283524V</b>	7W	24V	120	60-70 LM/W	>80	SMD	120°	WW	IP68	2835	50Mtr

### Dimension

PRODUCT CODE	LENGTH	WIDTH	HEIGHT
LS02835	50MTR	8MM	14.5MM
LS0283524V	50MTR	6.5MM	13MM

### Product Features

Rated Life : 30000 Hrs  
 Mounting Type : Surface mount  
 Housing & Finish : Flexible LED PCB

### Applications

Houses, Hotels, Restaurants, Resort, Showrooms

### RGB CONTROLLER

PRODUCT	PRODUCT CODE	COLOR
	LSRGB06	6 AMPS
	LSRGB12	12 AMPS
	LSRGB30	30 AMPS

### OUTDOOR STRIP CONNECTOR

PRODUCT	PRODUCT CODE	COLOR
	LSOC5050	WH, WW BLUE
	LSOC5050RGB	RGB

### NEON LED STRIP CONNECTOR

PRODUCT	PRODUCT CODE	COLOR
	LSOC2835	ALL COLORS

### LSO68 CONNECTOR WITH END CAP

PRODUCT	PRODUCT CODE	COLOR
	LSOC68	WHITE

### LSO68 FIXING TAPE

PRODUCT	PRODUCT CODE
	LSOTP68





**AMPIO**  
STRIP DRIVERS



# AMPIO STRIP DRIVER



# AMPIO OUTDOOR LED STRIP DRIVE

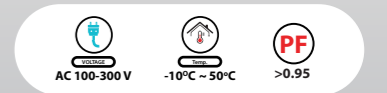

Product Code	Ampere	Input Voltage	Power Factor	Output Voltage	Power	Driver Efficiency	Over Voltage Prot.	Open & Short Circuit Prot.	IP Rating	Surge Voltage	THD
LSD02	2 AMPS	230V	>0.95	12V DC	24W	>87%	YES	YES	IP20	3 KV	<15%
LSD03	3 AMPS	230V	>0.95	12V DC	36W	>87%	YES	YES	IP20	3 KV	<15%
LSD05	5 AMPS	230V	>0.95	12V DC	60W	>87%	YES	YES	IP20	3 KV	<15%
LSD08	8 AMPS	230V	>0.95	12V DC	96W	>87%	YES	YES	IP20	3 KV	<15%
LSD12	12.5 AMPS	230V	>0.95	12V DC	150W	>87%	YES	YES	IP20	3 KV	<15%
LSD16	16 AMPS	230V	>0.95	12V DC	192W	>87%	YES	YES	IP20	3 KV	<15%
LSD20	20 AMPS	230V	>0.95	12V DC	240W	>87%	YES	YES	IP20	3 KV	<15%
LSD30	30 AMPS	230V	>0.95	12V DC	360W	>87%	YES	YES	IP20	3 KV	<15%

### Dimension (in mm)

PRODUCT CODE	LENGTH	WIDTH	HEIGHT
LSD02	98	37.56	27.26
LSD03	109	38.1	31.1
LSD05	134.79	40.73	31
LSD08	144.3	46.25	37.47
LSD12	220	52.20	37.6
LSD16	213	64	31
LSD20	213	64	31
LSD30	213	64	31

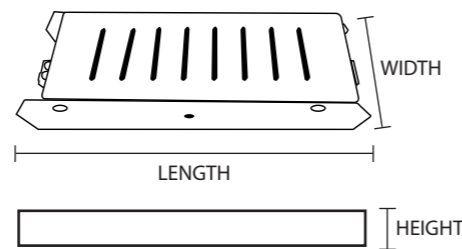

Product Code	Ampere	Input Voltage	Power Factor	Output Voltage	Power	Driver Efficiency	Over Voltage Prot.	Open & Short Circuit Prot.	IP Rating	Surge Voltage	THD
LUWD3	3 AMPS	230V	>0.95	24V DC	72W	>87%	YES	YES	IP65	3 KV	<15%
LUWD5	5 AMPS	230V	>0.95	24V DC	120W	>87%	YES	YES	IP65	3 KV	<15%
LUWD2	2.5 AMPS	230V	>0.95	24V DC	60W	>87%	YES	YES	IP65	3 KV	<15%
LUWD6	6.25 AMPS	230V	>0.95	24V DC	150W	>87%	YES	YES	IP65	3 KV	<15%

### Dimension (in mm)

PRODUCT CODE	LENGTH	WIDTH	HEIGHT
LUWD3	173.6	43.5	28.7
LUWD5	-	-	-
LUWD2	-	-	-
LUWD6	-	-	-

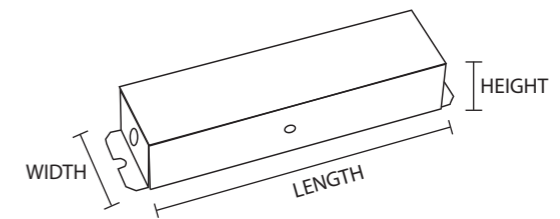

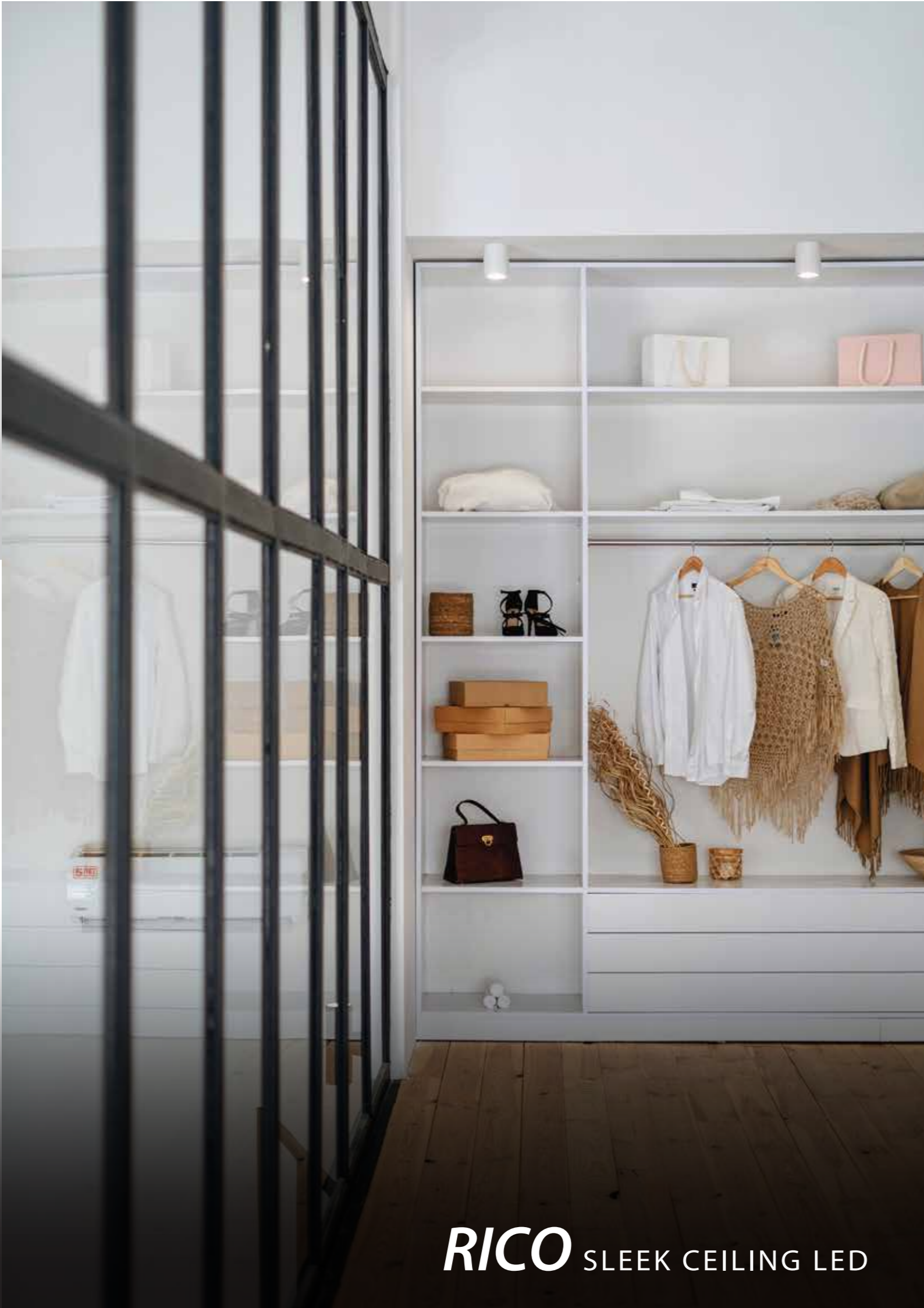

# RICO SLEEK CEILING LED

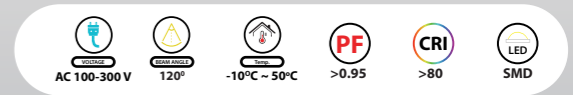

Product Code	Wattage	Voltage	Power Factor	System Luminous Efficacy	CRI	LED Light Source	Beam Angle	CCT	IP Rating	Surge Voltage	Body Finish
LCL03SSQ	3W	230V	>0.95	80 LM/W	>80	SMD	120°	WH,WW	IP20	2 KV	WHITE
LCL03SSW	3W	230V	>0.95	80 LM/W	>80	SMD	120°	WH	IP20	2 KV	WOOD
LCL03SRD	3W	230V	>0.95	80 LM/W	>80	SMD	120°	WH,WW BL,GR,RD,PK	IP20	2 KV	WHITE
LCL03SRW	3W	230V	>0.95	80 LM/W	>80	SMD	120°	WH	IP20	2 KV	WOOD

### Dimension (in mm)

PRODUCT CODE	DIA	HEIGHT	PRODUCT CODE	LENGTH	WIDTH	HEIGHT
LCL03SRD	60	10	LCL03SSQ	60	60	10
LCL03SRW	60	10	LCL03SSW	60	60	10

### Product Features

- Rated Life : 30000 Hrs
- Mounting Type : Surface Mounted
- Housing & Finish : Die Cast Aluminium + PC Diffuser

### Applications

Domestic, Commercial

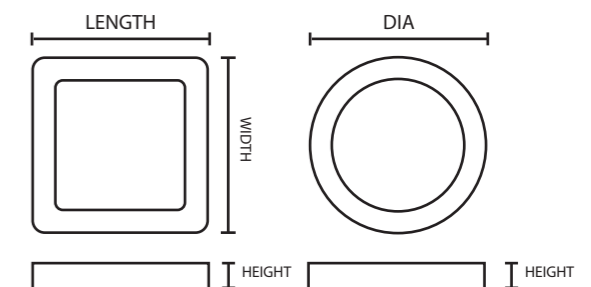

RICO SLEEK CEILING LED





# STRADA LED STREET LIGHTS

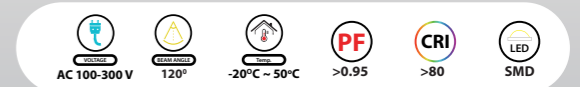
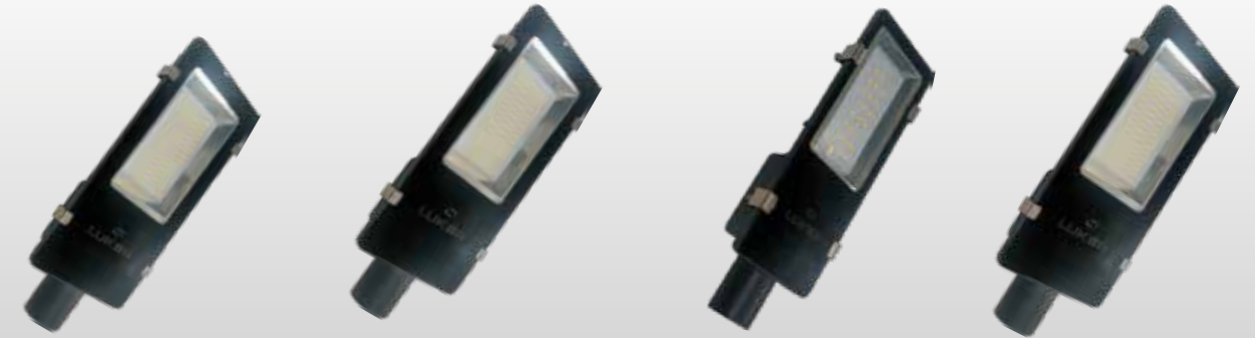

Product Code	Wattage	Voltage	Power Factor	System Luminous Efficacy	CRI	LED Light Source	Beam Angle	CCT	IP Rating	Surge Voltage	THD
LST-15	15W	230V	>0.95	100 LM/W	>80	SMD	120°	WH,WW	IP65	UPTO 20 KV	<5%
LST-24	24W	230V	>0.95	100 LM/W	>80	SMD	120°	WH,WW	IP65	UPTO 20 KV	<5%
LST-36	36W	230V	>0.95	100 LM/W	>80	SMD	120°	WH,WW	IP65	UPTO 20 KV	<5%
LST-48	48W	230V	>0.95	100 LM/W	>80	SMD	120°	WH,WW	IP65	UPTO 20 KV	<5%
LST-60	60W	230V	>0.95	100 LM/W	>80	SMD	120°	WH,WW	IP65	UPTO 20 KV	<5%
LST-72	72W	230V	>0.95	100 LM/W	>80	SMD	120°	WH,WW	IP65	UPTO 20 KV	<5%
LST-90	90W	230V	>0.95	100 LM/W	>80	SMD	120°	WH,WW	IP65	UPTO 20 KV	<5%
LST-120	120W	230V	>0.95	100 LM/W	>80	SMD	120°	WH,WW	IP65	UPTO 20 KV	<5%
LST-160	160W	230V	>0.95	100 LM/W	>80	SMD	120°	WH,WW	IP65	UPTO 20 KV	<5%

### Dimension (in mm)

PRODUCT CODE	LENGTH	WIDTH	HEIGHT	PIPE DIA. MAX
LST-15	280	100	60	33
LST-24	323	102	50	33
LST-36	336	119	50	33
LST-48	364	137	56	33
LST-60	364	137	70	33
LST-72	419	195	70	42
LST-90	419	195	70	42
LST-120	419	195	70	42
LST-160	521	250	86	60

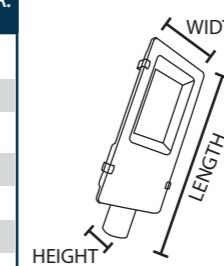

### Product Features

- Rated Life : 50000 Hrs
- Mounting Type : Pole Mounted
- Housing & Finish : Die Cast Aluminium + toughned Glass

### Applications

Domestic, Commercial, Industries,

**STRADA** LED STREET LIGHTS



# STREET & FLOOD LIGHTS SENSOR TYPE



# STRADA SLEEK LED STREET LIGHTS

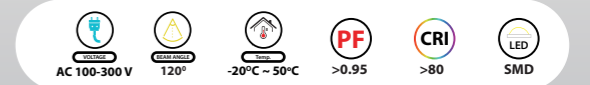
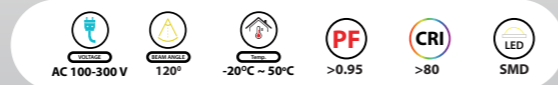

Product Code	Wattage	Voltage	Power Factor	System Luminous Efficacy	CRI	LED Light Source	Beam Angle	CCT	IP Rating	Surge Voltage	THD
LST-24SEN	24W	230V	>0.95	100 LM/W	>80	SMD	120°	WH,WW	IP65	UPTO 20 KV	<5%
LST-48SEN	48W	230V	>0.95	100 LM/W	>80	SMD	120°	WH,WW	IP65	UPTO 20 KV	<5%
LST-72SEN	72W	230V	>0.95	100 LM/W	>80	SMD	120°	WH,WW	IP65	UPTO 20 KV	<5%
LST-120SEN	120W	230V	>0.95	100 LM/W	>80	SMD	120°	WH,WW	IP65	UPTO 20 KV	<5%
LFL50SEN	50W	230V	>0.95	100 LM/W	>80	SMD	120°	WH,WW	IP65	UPTO 20 KV	<5%

### Dimension (in mm)

PRODUCT CODE	LENGTH	WIDTH	HEIGHT	PIPE DIA. MAX
LST-24SEN	323	102	50	33
LST-48SEN	364	137	56	33
LST-72SEN	419	195	70	42
LST-120SEN	419	195	70	42
LFL50SEN	247	255	45	-

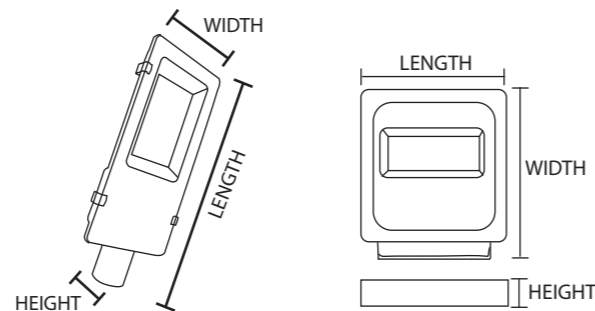

### Product Features

- Rated Life : 50000 Hrs
- Mounting Type : Pole Mounted
- Housing & Finish : Die Cast Aluminium + toughned Glass

### Applications

Domestic, Commercial, Industries,

Product Code	Wattage	Voltage	Power Factor	System Luminous Efficacy	CRI	LED Light Source	Beam Angle	CCT	IP Rating	Surge Voltage	THD
LSTE-20	20W	230V	>0.95	100 LM/W	>80	SMD	120°	WH	IP65	6 KV	<5%
LSTE-30	30W	230V	>0.95	100 LM/W	>80	SMD	120°	WH	IP65	6 KV	<5%
LSTE-50	50W	230V	>0.95	100 LM/W	>80	SMD	120°	WH	IP65	6 KV	<5%
LSTE-80	80W	230V	>0.95	100 LM/W	>80	SMD	120°	WH	IP65	6 KV	<5%
LSTE-100	100W	230V	>0.95	100 LM/W	>80	SMD	120°	WH	IP65	6 KV	<5%
LSTE-120	120W	230V	>0.95	100 LM/W	>80	SMD	120°	WH	IP65	6 KV	<5%

### Dimension (in mm)

PRODUCT CODE	LENGTH	WIDTH	HEIGHT	PIPE DIA. MAX
LSTE-20	260	108	60	42
LSTE-30	310	125	60	45
LSTE-50	365	165	60	45
LSTE-60	375	165	60	42
LSTE-80	375	163	60	42
LSTE-100	432	195	70	48
LSTE-120	432	195	70	48

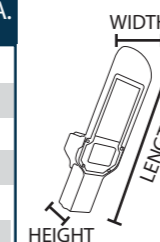

### Product Features

- Rated Life : 50000 Hrs
- Mounting Type : Pole Mounted
- Housing & Finish : Die Cast Aluminium + toughned Glass

### Applications

Domestic, Commercial, Industries,







***LED FLOOD LIGHTS***

# ALCOR LED FLOOD LIGHTS



# ALCOR LED FLOOD LIGHTS

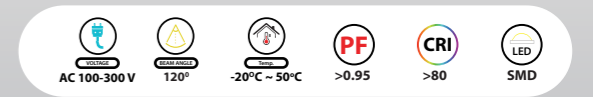
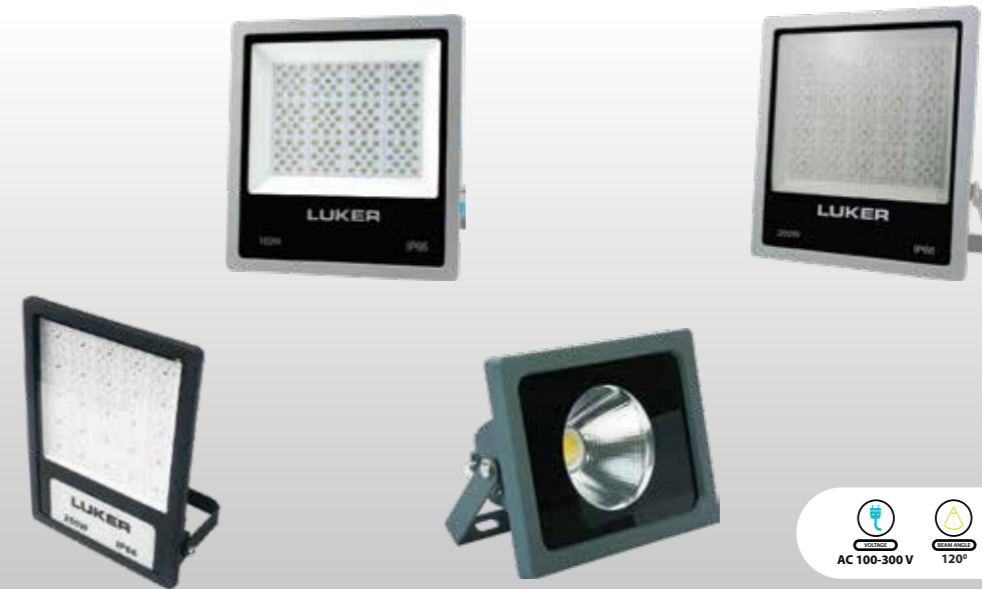
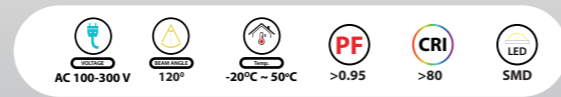

Product Code	Wattage	Voltage	Power Factor	System Luminous Efficacy	CRI	LED Light Source	Beam Angle	CCT	IP Rating	Surge Voltage	THD
LFL10	10W	230V	>0.95	100 LM/W	>80	SMD	120°	WH,WW BL,GR	IP66	6 KV	<5%
LFLR10	10W	230V	>0.95	100 LM/W	>80	SMD	120°	RGB	IP66	6 KV	<5%
LFL20	20W	230V	>0.95	100 LM/W	>80	SMD	120°	WH,WW BL,GR	IP66	6 KV	<5%
LFLR20	20W	230V	>0.95	100 LM/W	>80	SMD	120°	RGB	IP66	6 KV	<5%
LFL30	30W	230V	>0.95	100 LM/W	>80	SMD	120°	WH,WW BL,GR	IP66	6 KV	<5%
LFLR30	30W	230V	>0.95	100 LM/W	>80	SMD	120°	RGB	IP66	6 KV	<5%
LFL50	50W	230V	>0.95	100 LM/W	>80	SMD	120°	WH,WW BL,GR	IP66	6 KV	<5%
LFLR50	50W	230V	>0.95	100 LM/W	>80	SMD	120°	RGB,GDY	IP66	6 KV	<5%

Product Code	Wattage	Voltage	Power Factor	System Luminous Efficacy	CRI	LED Light Source	Beam Angle	CCT	IP Rating	Surge Voltage	THD
LFL100	100W	230V	>0.95	100 LM/W	>80	SMD	120°	WH,WW	IP66	6 KV	<5%
LFL160	160W	230V	>0.95	100 LM/W	>80	SMD	120°	WH,WW GR	IP66	6 KV	<5%
LFL200	200W	230V	>0.95	100 LM/W	>80	SMD	120°	WH,WW	IP66	6 KV	<5%
LFL250	250W	230V	>0.95	100 LM/W	>80	SMD	120°	WH	IP66	6 KV	<5%
LFL300	300W	230V	>0.95	100 LM/W	>80	SMD	120°	WH	IP66	6 KV	<5%
LFLCOB20	20W	230V	>0.95	100 LM/W	>80	SMD	120°	WH	IP65	6 KV	<5%
LFLCOB50	50W	230V	>0.95	100 LM/W	>80	SMD	120°	WH	IP65	6 KV	<5%

### Dimension (in mm)

PRODUCT CODE	LENGTH	WIDTH	HEIGHT
LFL10	110	130	35
LFLR10	110	130	35
LFL20	137	160	40
LFLR20	137	160	40
LFL30	167	184	42
LFLR30	167	184	42
LFL50	208	237	46
LFLR50	208	237	46

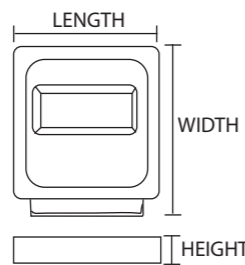

### Product Features

Rated Life : 50000 Hrs  
 Mounting Type : Wall / Surface Mounted  
 Housing & Finish : Die Cast Aluminium + toughned Glass

### Applications

Domestic, Commercial, Industries,

### Dimension (in mm)

PRODUCT CODE	LENGTH	WIDTH	HEIGHT
LFL100	292	252	55
LFL160	305	305	55
LFL200	375	375	120
LFL250	433	320	47
LFL300	433	320	47
LFLCOB20	185	150	115
LFLCOB50	285	230	145

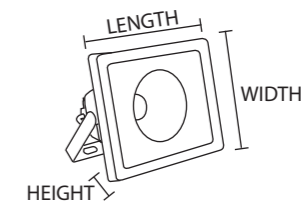
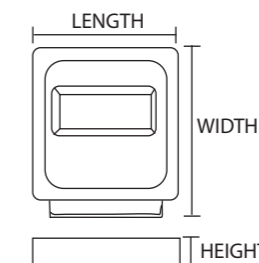

### Product Features

Rated Life : 50000 Hrs  
 Mounting Type : Wall / Surface Mounted  
 Housing & Finish : Die Cast Aluminium + toughned Glass

### Applications

Domestic, Commercial, Industries,





# ALCOR SG LED FLOOD LIGHTS



# ALCOR SG LED FLOOD LIGHTS

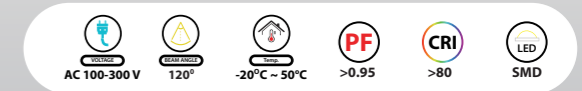
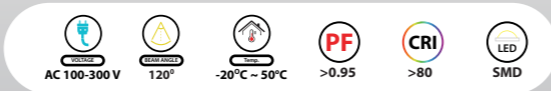

Product Code	Wattage	Voltage	Power Factor	System Luminous Efficacy	CRI	LED Light Source	Beam Angle	CCT	IP Rating	Surge Voltage	THD
LFLSL10SG	10W	230V	>0.95	100 LM/W	>80	SMD	120°	WH,WW	IP66	6 KV	<5%
LFLSL20SG	20W	230V	>0.95	100 LM/W	>80	SMD	120°	WH,WW	IP66	6 KV	<5%
LFLSL30SG	30W	230V	>0.95	100 LM/W	>80	SMD	120°	WH,WW	IP66	6 KV	<5%
LFLSL50SG	50W	230V	>0.95	100 LM/W	>80	SMD	120°	WH,WW	IP66	6 KV	<5%
LFLSL80SG	80W	230V	>0.95	100 LM/W	>80	SMD	120°	WH	IP66	6 KV	<5%

### Dimension (in mm)

PRODUCT CODE	LENGTH	WIDTH	HEIGHT
LFLSL10SG	150	120	30
LFLSL20SG	170	140	30
LFLSL30SG	190	160	30
LFLSL50SG	210	180	30
LFLSL80SG	280	240	30

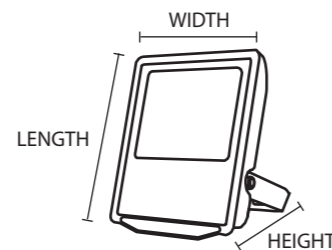

### Product Features

Rated Life : 50000 Hrs  
 Mounting Type : Wall / Surface Mounted  
 Housing & Finish : Die Cast Aluminium + toughned Glass

### Applications

Domestic, Commercial, Industries,



Product Code	Wattage	Voltage	Power Factor	System Luminous Efficacy	CRI	LED Light Source	Beam Angle	CCT	IP Rating	Surge Voltage	THD
LFLSL100NSG	100W	230V	>0.95	100 LM/W	>80	SMD	120°	WH,WW	IP66	6 KV	<5%
LFLSL150NSG	150W	230V	>0.95	100 LM/W	>80	SMD	120°	WH,WW	IP66	6 KV	<5%
LFLSL200NSG	200W	230V	>0.95	100 LM/W	>80	SMD	120°	WH,WW	IP66	6 KV	<5%
LFLSL250NSG	250W	230V	>0.95	100 LM/W	>80	SMD	120°	WH	IP66	6 KV	<5%
LFLSL300NSG	300W	230V	>0.95	100 LM/W	>80	SMD	120°	WH	IP66	6 KV	<5%
LFLSL400NSG	400W	230V	>0.95	100 LM/W	>80	SMD	120°	WH	IP66	6 KV	<5%
LFLSL500	500W	230V	>0.95	100 LM/W	>80	SMD	120°	WH	IP66	6 KV	<5%

### Dimension (in mm)

PRODUCT CODE	LENGTH	WIDTH	HEIGHT
LFLSL100NSG	280	240	30
LFLSL150NSG	350	270	36
LFLSL200NSG	420	300	36
LFLSL250NSG	480	350	40
LFLSL300NSG	480	350	40
LFLSL400NSG	480	350	40
LFLSL500	515	410	45

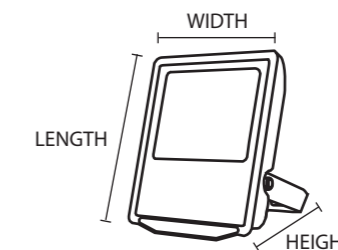

### Product Features

Rated Life : 50000 Hrs  
 Mounting Type : Wall / Surface Mounted  
 Housing & Finish : Die Cast Aluminium + toughned Glass

### Applications

Domestic, Commercial, Industries,







# ENDEAVOUR LED FLOOD LIGHTS



Product Code	Wattage	Voltage	Power Factor	System Luminous Efficacy	CRI	LED Light Source	Beam Angle	CCT	IP Rating	Surge Voltage	THD
<b>LFLHL150</b>	150W	230V	>0.95	100 LM/W	>80	SMD	120°	WH	IP65	6 KV	<5%
<b>LFLHL200</b>	200W	230V	>0.95	100 LM/W	>80	SMD	120°	WH	IP65	6 KV	<5%
<b>LFLHL300</b>	300W	230V	>0.95	100 LM/W	>80	SMD	120°	WH	IP65	6 KV	<5%
<b>LFLHL350</b>	350W	230V	>0.95	100 LM/W	>80	SMD	120°	WH	IP65	6 KV	<5%

### Dimension (in mm)

PRODUCT CODE	LENGTH	WIDTH	HEIGHT
LFLHL150	370	355	65
LFLHL200	450	355	65
LFLHL300	610	355	65
LFLHL350	685	355	65

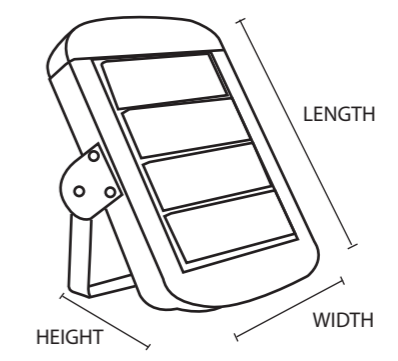

### Product Features

- Rated Life : 50000 Hrs
- Mounting Type : Wall / Surface Mounted
- Housing & Finish : Die Cast Aluminium + toughened Glass

### Applications

Domestic, Commercial, Industries,

**LED FLOOD LIGHTS**







# NELLA IP65 LED TUNNEL LIGHTS

# NELLA IP65 LED TUNNEL LIGHTS



Product Code	Wattage	Voltage	Power Factor	System Luminous Efficacy	CRI	LED Light Source	Beam Angle	CCT	IP Rating	Surge Voltage	THD
LFLHL30	30W	230V	>0.95	100 LM/W	>80	SMD	120°	WH	IP65	6 KV	<10%
LFLHL50	50W	230V	>0.95	100 LM/W	>80	SMD	120°	WH	IP65	6 KV	<10%

### Dimension (in mm)

PRODUCT CODE	LENGTH	WIDTH	HEIGHT (Incl.Clamp)
LFLHL30	300	70	220
LFLHL50	300	70	220

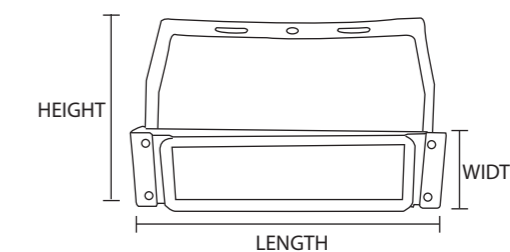

### Product Features

- Rated Life : 50000 Hrs
- Mounting Type : Wall / Surface Mounted
- Housing & Finish : Die Cast Aluminium + toughned Glass

### Applications

Domestic, Commercial, Industries,





**WELL GLASS &  
CANOPY LIGHTS**



# FARO WELL GLASS LED LIGHTS



# CENNO CANOPY LED LIGHTS

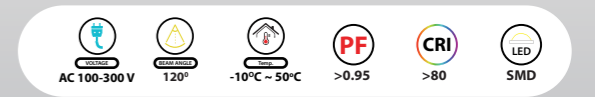
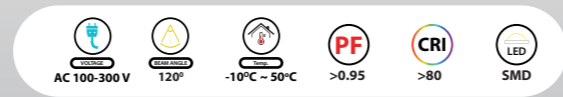

Product Code	Wattage	Voltage	Power Factor	System Luminous Efficacy	CRI	LED Light Source	Beam Angle	CCT	IP Rating	Surge Voltage	THD
LW040	40W	230V	>0.95	100 LM/W	>80	SMD	120°	WH	IP65	6 KV	<5%
LW070	70W	230V	>0.95	100 LM/W	>80	SMD	120°	WH	IP65	6 KV	<5%

### Dimension (in mm)

PRODUCT CODE	DIA	HEIGHT
LW040	160	155
LW070	205	190

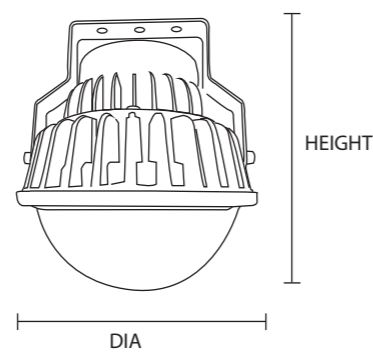

### Product Features

- Rated Life : 50000 Hrs
- Mounting Type : Wall / Surface Mounted
- Housing & Finish : Die Cast Aluminium + toughned Glass

### Applications

Domestic, Commercial, Industries,



Product Code	Wattage	Voltage	Power Factor	System Luminous Efficacy	CRI	LED Light Source	Beam Angle	CCT	IP Rating	Surge Voltage	THD
LPB080	80W	230V	>0.95	100 LM/W	>80	SMD	120°	WH	IP65	6 KV	<5%
LPB080N	80W	230V	>0.95	100 LM/W	>80	SMD	120°	WH	IP65	6 KV	<5%

### Dimension (in mm)

PRODUCT CODE	LENGTH	WIDTH	HEIGHT
LPB080	325	325	80
LPB080N	375	375	180

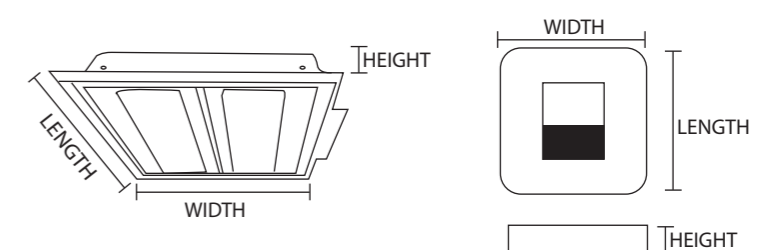

### Product Features

- Rated Life : 50000 Hrs
- Mounting Type : Recess Mounted
- Housing & Finish : Die Cast Aluminium + PC Diffuser

### Applications

Commercial, Industrial,





# ARCO WALL WASHER LED LIGHTS



Product Code	Wattage	Voltage	Power Factor	System Luminous Efficacy	CRI	LED Light Source	Beam Angle	CCT	IP Rating	Surge Voltage	THD
<b>LODWW10</b>	10W	230V	>0.95	100 LM/W	>80	COB	10°	WH,WW BL,GR,GDY	IP65	3 KV	<15%
<b>LODWW18</b>	18W	230V	>0.95	100 LM/W	>80	COB	10°	WH,BL GDY	IP65	3 KV	<15%
<b>LODWW12</b>	12W	230V	>0.95	100 LM/W	>80	COB	30°	BL	IP65	3 KV	<15%
<b>LODWW24</b>	24W	230V	>0.95	100 LM/W	>80	COB	30°	BL	IP65	3 KV	<15%

### Dimension (in mm)

PRODUCT CODE	LENGTH	WIDTH	HEIGHT
LODWW10	150	70	-
LODWW18	149	88.5	154
LODWW12	500	60	60
LODWW24	1000	60	60

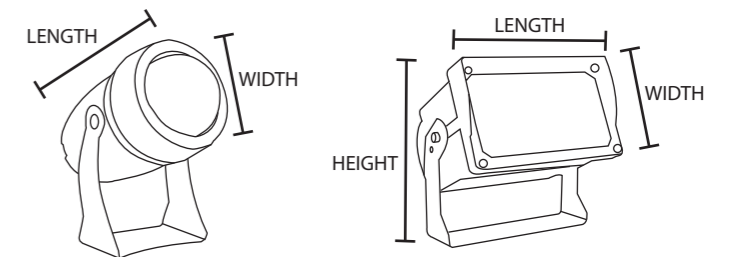

### Product Features

- Rated Life : 30000 Hrs
- Mounting Type : Surface Mounted
- Housing & Finish : Die Cast Aluminium + Glass

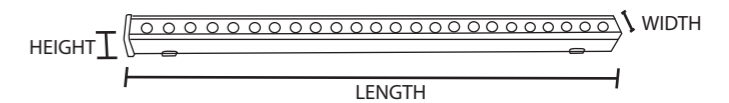

### Applications

Domestic, Commercial, Exterior Lighting

## WALL WASHER LED LIGHTS







***HIGH BAY LIGHTS***



# AVIOR LOW BAY & HIGH BAY LED



# AVIOR LOW BAY & HIGH BAY LED

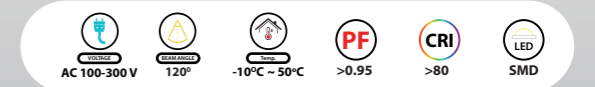
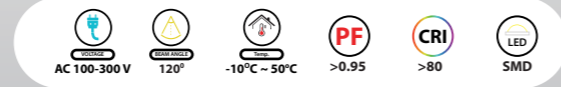

Product Code	Wattage	Voltage	Power Factor	System Luminous Efficacy	CRI	LED Light Source	Beam Angle	CCT	IP Rating	Surge Voltage	THD
LHBYC40	40W	230V	>0.95	100 LM/W	>80	SMD	120°	WH	IP40	10 KV	<5%
LHBY50	50W	230V	>0.95	100 LM/W	>80	SMD	120°	WH	IP40	10 KV	<5%
LHBY70	70W	230V	>0.95	100 LM/W	>80	SMD	120°	WH	IP40	10 KV	<5%
LHBY100	100W	230V	>0.95	100 LM/W	>80	SMD	120°	WH	IP40	10 KV	<5%
LHBY120	1200W	230V	>0.95	100 LM/W	>80	SMD	120°	WH	IP40	10 KV	<5%
LHBY150	150W	230V	>0.95	100 LM/W	>80	SMD	120°	WH	IP40	10 KV	<5%
LHBY200	200W	230V	>0.95	100 LM/W	>80	SMD	120°	WH	IP40	10 KV	<5%

### Dimension (in mm)

PRODUCT CODE	DIA	HEIGHT
LHBYC40	350	210
LHBY50	350	285
LHBY70	350	285
LHBY100	500	260
LHBY120	500	270
LHBY150	500	270
LHBY200	500	270

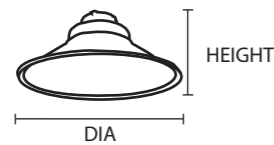

### Product Features

- Rated Life : 50000 Hrs
- Mounting Type : Suspended Mount
- Housing & Finish : Die Cast Alu. Body + Clear Anodised Alu. Diffuser

### Applications

Industries, Warehouse, Commercial



Product Code	Wattage	Voltage	Power Factor	System Luminous Efficacy	CRI	LED Light Source	Beam Angle	CCT	IP Rating	Surge Voltage	THD
LOHY50	50W	230V	>0.95	100 LM/W	>80	SMD	120°	WH	IP65	10 KV	<5%
LOHY100	100W	230V	>0.95	100 LM/W	>80	SMD	120°	WH	IP65	10 KV	<5%
LOHY150	150W	230V	>0.95	100 LM/W	>80	SMD	120°	WH	IP65	10 KV	<5%
LOHY200	200W	230V	>0.95	100 LM/W	>80	SMD	120°	WH	IP65	10 KV	<5%
LHBY150HL	150W	230V	>0.95	100 LM/W	>80	SMD	120°	WH	IP65	10 KV	<5%

### Dimension (in mm)

PRODUCT CODE	DIA	HEIGHT
LOHY50	245	135
LOHY100	362	141
LOHY150	320	138
LOHY200	360	138

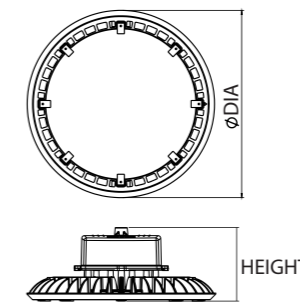

PRODUCT CODE	LENGTH	WIDTH	HEIGHT
LHBY150HL	965	90	60

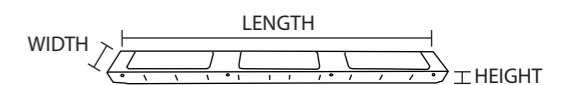

### Product Features

- Rated Life : 50000 Hrs
- Mounting Type : Suspended Mount
- Housing & Finish : Die Cast Aluminium + toughned Glass

### Applications

Industries, Warehouse, Commercial







***LINEAR LED LIGHTING***

# LUSSO LINEAR LIGHTING (ASSEMBLED)

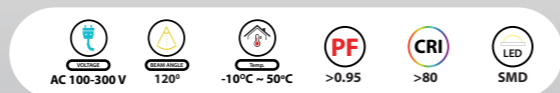

# LUSSO LINEAR LIGHTING (ASSEMBLED)

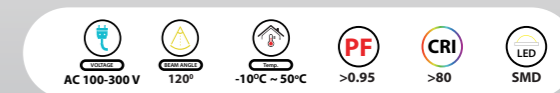

Product Code	Wattage	Voltage	Power Factor	System Luminous Efficacy	CRI	LED Light Source	Beam Angle	CCT	IP Rating	Surge Voltage	THD
LPL70501M	43W	230V	>0.95	80 LM/W	>80	SMD	120°	WH,WW NW	IP20	3 KV	<15%
LPL70502M	86W	230V	>0.95	80 LM/W	>80	SMD	120°	WH,WW NW	IP20	3 KV	<15%

### Dimension (in mm)

PRODUCT CODE	LENGTH	WIDTH	HEIGHT
LPL70501M	1219	50	70
LPL70502M	2438	50	70

### Product Features

Rated Life : 50000 Hrs  
 Mounting Type : Suspended Mount  
 Housing & Finish : Die Cast Aluminium + PC Diffuser

### Applications

Houses, Offices, Hospitals, Showrooms, Hotels,



Product Code	Wattage	Voltage	Power Factor	System Luminous Efficacy	CRI	LED Light Source	Beam Angle	CCT	IP Rating	Surge Voltage	THD
LPL50351M	36W	230V	>0.95	70 LM/W	>80	SMD	120°	WH,WW NW	IP20	3 KV	<15%
LPL50352M	72W	230V	>0.95	70 LM/W	>80	SMD	120°	WH,WW NW	IP20	3 KV	<15%

### Dimension (in mm)

PRODUCT CODE	LENGTH	WIDTH	HEIGHT
LPL50351M	1000	50	35
LPL50352M	2000	50	35

### Product Features

Rated Life : 50000 Hrs  
 Mounting Type : Suspended Mount  
 Housing & Finish : Die Cast Aluminium + PC Diffuser

### Applications

Houses, Offices, Hospitals, Showrooms, Hotels,





# LUSSO LED LINEAR LIGHTING



# LUSSO LED LINEAR LIGHTING



**Product Code** : LPL1809  
 Mount type : Concealed  
 Body Material : Alu + PC Diffuser  
 Body Color : Aluminium Finish  
 IP Rating : IP20  
 Standard Length : 2 Meter  
 Accessory : 2 End Caps & 3 Clamps

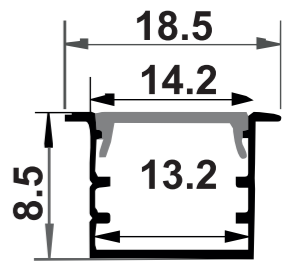

**Product Code** : LPL1010  
 Mount type : Concealed  
 Body Material : Alu + PC Diffuser  
 Body Color : Aluminium Finish  
 IP Rating : IP20  
 Standard Length : 2 Meter  
 Accessory : 2 End Caps & 3 Clamps

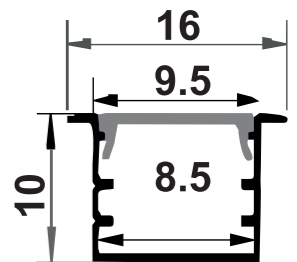

**Product Code** : LPL1413  
 Mount type : Concealed  
 Body Material : Alu + PC Diffuser  
 Body Color : Aluminium Finish  
 IP Rating : IP20  
 Standard Length : 2 Meter  
 Accessory : 2 End Caps & 3 Clamps

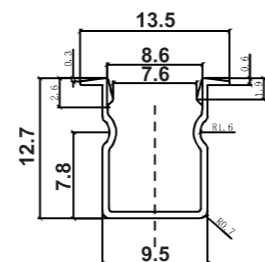

**Product Code** : LPL4026  
 Mount type : Concealed  
 Body Material : Alu + PC Diffuser  
 Body Color : Aluminium Finish  
 IP Rating : IP20  
 Standard Length : 2 Meter  
 Accessory : 2 End Caps & 3 Clamps

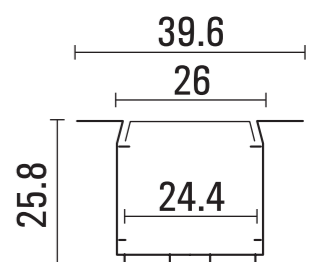

**Product Code** : LPL2514  
 Mount type : Concealed  
 Body Material : Alu + PC Diffuser  
 Body Color : Aluminium Finish  
 IP Rating : IP20  
 Standard Length : 2 Meter  
 Accessory : 2 End Caps & 3 Clamps

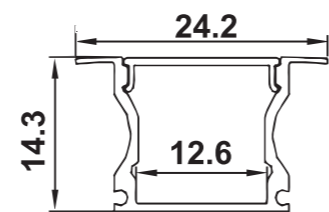

**Product Code** : LPL5035  
 Mount type : Concealed  
 Body Material : Alu + PC Diffuser  
 Body Color : White Powder Coated  
 IP Rating : IP20  
 Standard Length : 2 Meter  
 Accessory : 2 End Caps & 3 Clamps

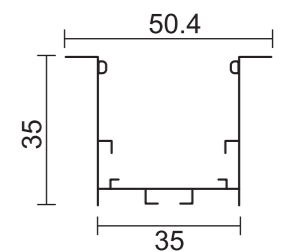

**Product Code** : LPL2514 BK  
 Mount type : Concealed  
 Body Material : Alu + PC Diffuser  
 Body Color : Black Finish  
 IP Rating : IP20  
 Standard Length : 2 Meter  
 Accessory : 2 End Caps & 3 Clamps

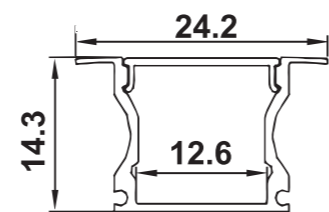

**Product Code** : LPL4435  
 Mount type : Concealed  
 Body Material : Alu + PC Diffuser  
 Body Color : White Powder Coated  
 IP Rating : IP20  
 Standard Length : 2 Meter  
 Accessory : 2 End Caps & 3 Clamps

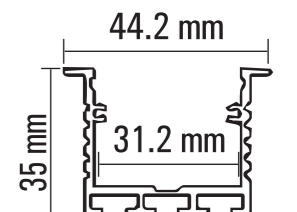

# ALCUNO LED LINEAR LIGHTING COMPONENTS

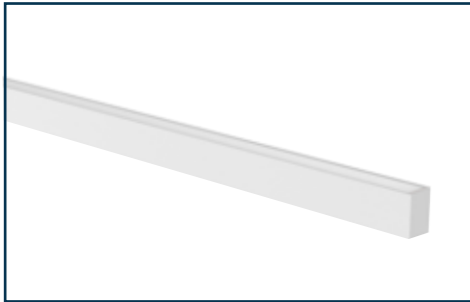

**Product Code** : LPL7050  
 Mount type : Surface  
 Body Material : Alu + PC Diffuser  
 Body Color : White Powder Coated  
 IP Rating : IP20  
 Standard Length : 2 Meter / 2.5 Meter  
 Accessory : 2 End Caps & 3 Clamps

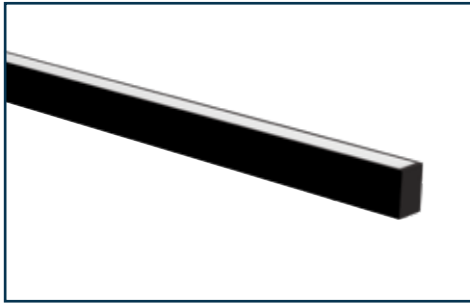
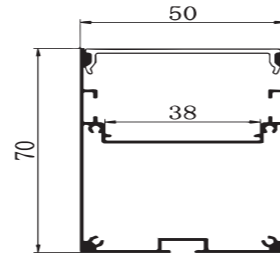

**Product Code** : LPL7050 BK  
 Mount type : Surface  
 Body Material : Alu + PC Diffuser  
 Body Color : Black Finish  
 IP Rating : IP20  
 Standard Length : 2 Meter / 2.5 Meter  
 Accessory : 2 End Caps & 3 Clamps

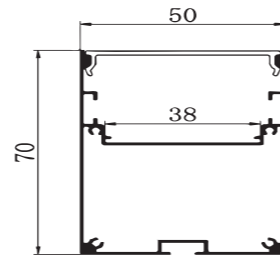

**Product Code** : LPL4320 BK  
 Mount type : Concealed  
 Body Material : Alu + PC Diffuser  
 Body Color : Black Finish  
 IP Rating : IP20  
 Standard Length : 2 Meter  
 Accessory : 2 End Caps & 3 Clamps

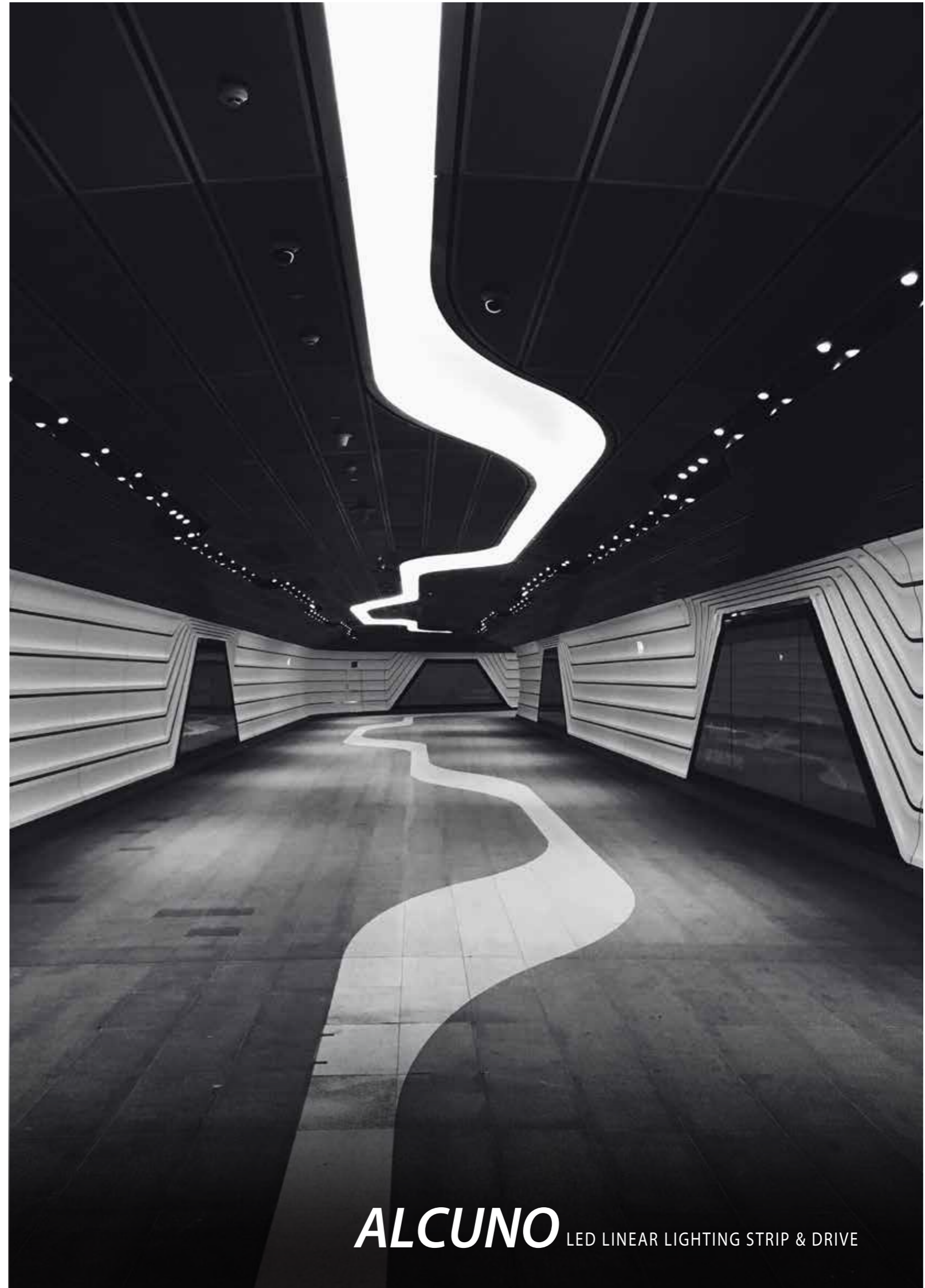
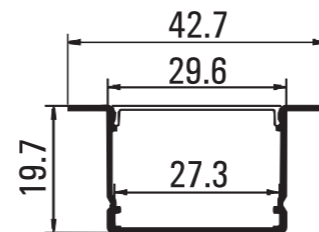



# LUSSO LED LINEAR LIGHTING



# LUSSO LED LINEAR LIGHTING



**Product Code** : LPL3535  
 Mount type : Surface  
 Body Material : Alu + PC Diffuser  
 Body Color : White Powder Coated  
 IP Rating : IP20  
 Standard Length : 2 Meter  
 Accessory : 2 End Caps & 3 Clamps

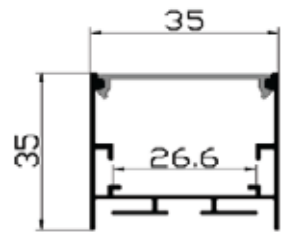

**Product Code** : LPL5015  
 Mount type : Surface  
 Body Material : Alu + PC Diffuser  
 Body Color : White Powder Coated  
 IP Rating : IP20  
 Standard Length : 2 Meter  
 Accessory : 2 End Caps & 3 Clamps

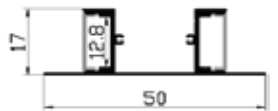

**Product Code** : LPL1805  
 Mount type : Surface  
 Body Material : Alu + PC Diffuser  
 Body Color : Aluminium Finish  
 IP Rating : IP20  
 Standard Length : 2 Meter  
 Accessory : 2 End Caps & 3 Clamps

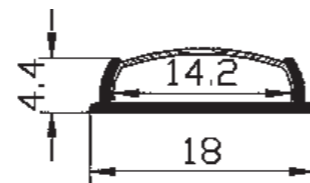

**Product Code** : LPL2015  
 Mount type : Surface  
 Body Material : Alu + PC Diffuser  
 Body Color : Aluminium Finish  
 IP Rating : IP20  
 Standard Length : 2 Meter  
 Accessory : 2 End Caps & 3 Clamps

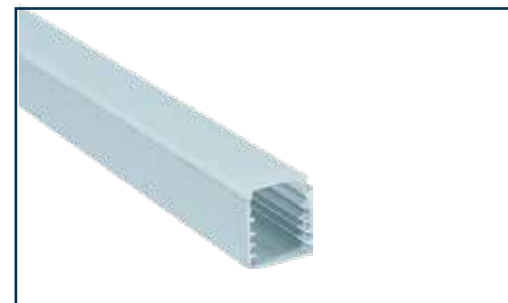
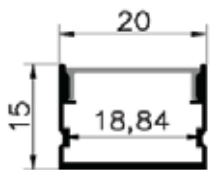

**Product Code** : LPL1414  
 Mount type : Surface  
 Body Material : Alu + PC Diffuser  
 Body Color : Aluminium Finish  
 IP Rating : IP20  
 Standard Length : 2 Meter  
 Accessory : 2 End Caps & 3 Clamps

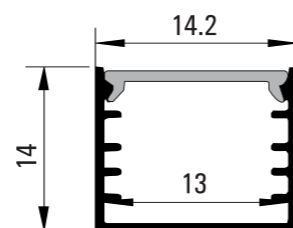

**Product Code** : LPL2025  
 Mount type : Surface  
 Body Material : Alu + PC Diffuser  
 Body Color : White Powder Coated  
 IP Rating : IP20  
 Standard Length : 2 Meter  
 Accessory : 2 End Caps & 3 Clamps

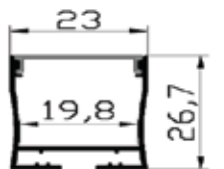

**Product Code** : LPL2115  
 Mount type : Corner Surface  
 Body Material : Alu + PC Diffuser  
 Body Color : Aluminium Finish  
 IP Rating : IP20  
 Standard Length : 2 Meter  
 Accessory : 2 End Caps & 3 Clamps

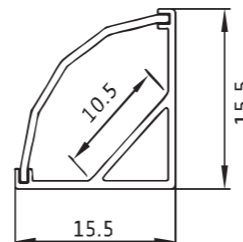

**Product Code** : LPL3020 BK  
 Mount type : Surface  
 Body Material : Alu + PC Diffuser  
 Body Color : Black Finish  
 IP Rating : IP20  
 Standard Length : 2 Meter  
 Accessory : 2 End Caps & 3 Clamps

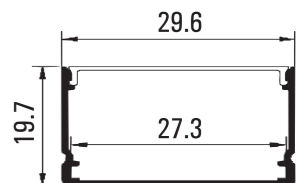

# ALCUNO LED LINEAR LIGHTING STRIP

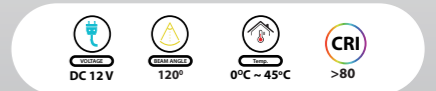
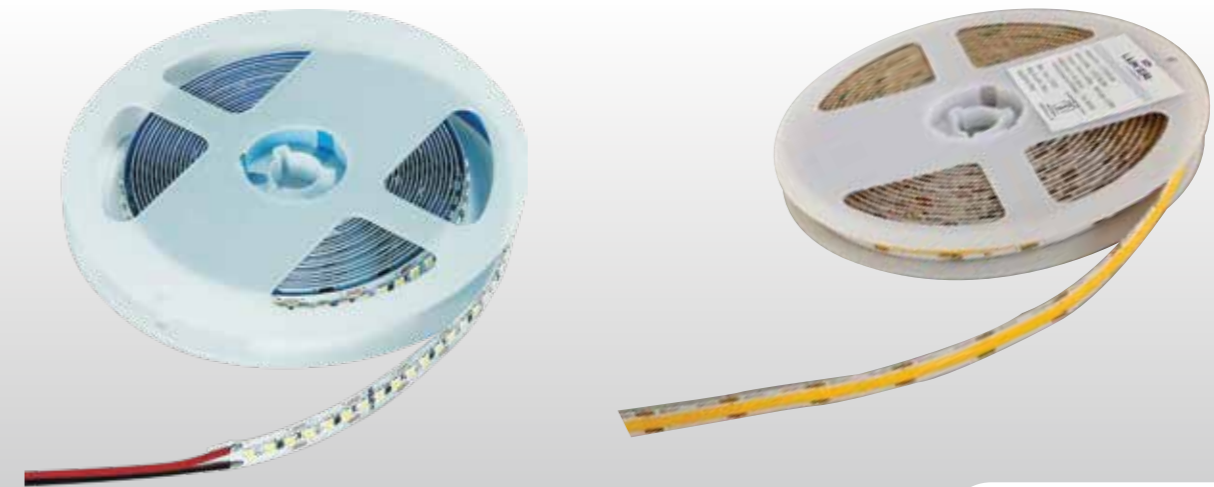

Product Code	Wattage	Voltage	LED's/ Meter	System Luminous Efficacy	CRI	LED Light Source	Beam Angle	CCT	IP Rating	LED Size	STD PKG.
<b>LPLS120</b>	12W	12V DC	120	60-70 LM/W	>80	SMD	120°	WH,WW NW,BL	IP20	2835	5 MTR
<b>LPLS180</b>	18W	12V DC	180	60-70 LM/W	>80	SMD	120°	WH,WW NW,BL	IP20	2835	5 MTR
<b>LPLS240</b>	20W	12V DC	240	60-70 LM/W	>80	SMD	120°	WH,WW NW	IP20	2835	5 MTR
<b>LSCOB384</b>	12W	12V DC	384	60-70 LM/W	>80	COB	120°	WW	IP20	-	5 MTR

### Dimension (in mm)

PRODUCT CODE	LENGTH	WIDTH	HEIGHT
LPLS120	5000	7.9	1.40
LPLS180	5000	9.84	1.33
LPLS240	5000	9.9	1.40
LSCOB384	5000	10.1	1.8

### Product Features

Rated Life : 30000 Hrs  
 Mounting Type : Surface mount  
 Housing & Finish : Flexible LED PCB

### Applications

Houses, Hotels, Restaurants, Resort, Showrooms

**ALCUNO**  
LED LINEAR LIGHTING STRIP & DRIVE





# ALCUNO ACCESSORIES

## HANGING KIT - 1 MTR



MODEL	QUANTITY	BODY COLOR
LPLSHK	1 PAIR	CHROME

## HANGING KIT - 2 MTR



MODEL	QUANTITY	BODY COLOR
LPLDHK	1 PAIR	CHROME

## STRAIGHT CONNECTOR



MODEL	SUITABLE FOR	BODY COLOR
LPLSTCN	LPL3535, LPL4435, LPL5035	CHROME

## 45° SIDE ANGLE CONNECTOR



MODEL	SUITABLE FOR	BODY COLOR
LPL45INCN	LPL3535, LPL4435, LPL5035	CHROME

## 45° TOP ANGLE CONNECTOR

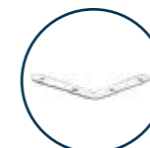

MODEL	SUITABLE FOR	BODY COLOR
LPL45EXCN	LPL3535, LPL4435, LPL5035	CHROME

## SURFACE MOUNTING CLIPS



MODEL	SUITABLE FOR	BODY COLOR
LPLCL01	LPL2514, LPL0192, LPL2967	CHROME

## RECESS MOUNTING SPRING CLIPS



MODEL	SUITABLE FOR	BODY COLOR
LPLCL02	LPL4435, LPL2319	CHROME

# EMERGENCY LIGHTS



Product Code	Wattage	Voltage	Power Factor	System Luminous Efficacy	CRI	LED Light Source	Beam Angle	CCT	IP Rating	Surge Voltage	THD
--------------	---------	---------	--------------	--------------------------	-----	------------------	------------	-----	-----------	---------------	-----

### FOCO EMERGENCY BULB

<b>LBGB09CL</b>	9W	230V	>0.95	100 LM/W	>80	SMD	120°	WH	IP40	3 KV	<15%
<b>LBGB12CL</b>	12W	230V	>0.95	100 LM/W	>80	SMD	120°	WH	IP40	3 KV	<15%

### LUMOS EMERGENCY TUBE

<b>LTGT520</b>	20W	230V	>0.95	100 LM/W	>80	SMD	120°	WH	IP40	3 KV	<15%
----------------	-----	------	-------	----------	-----	-----	------	----	------	------	------

### IRIS EMERGENCY PANEL

<b>LNSPELRDE0015</b>	11x18W	230V	>0.95	100 LM/W	>80	SMD	120°	WH	IP40	3 KV	<15%
----------------------	--------	------	-------	----------	-----	-----	------	----	------	------	------

### Dimension (in mm)

PRODUCT CODE	LENGTH	WIDTH	HEIGHT
LTGT520	1190	20	30

PRODUCT CODE	DIA	HEIGHT	CUT-OUT
LNSPELRDE0015	170	20	155

PRODUCT CODE	DIA	HEIGHT
LBGB09CL	70	145
LBGB12CL	80	155

### MODE OF OPERATION

**Normal AC Mode:** Connect the pannel into the AC supply, it will Turn on and charge the battery at the same time.

**Emergency Mode:** When power failure, the light will glow automatically and the light will last upto 2 hours if it is fully charged.

# EMERGENCY LIGHTS





# VICINO SMART BACKLIT PANEL

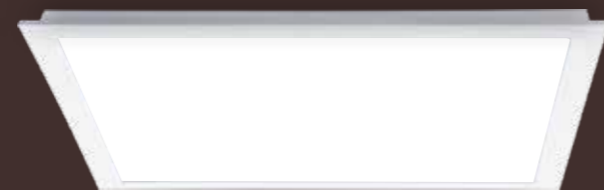
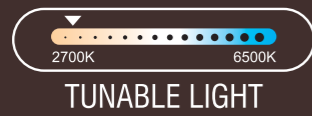
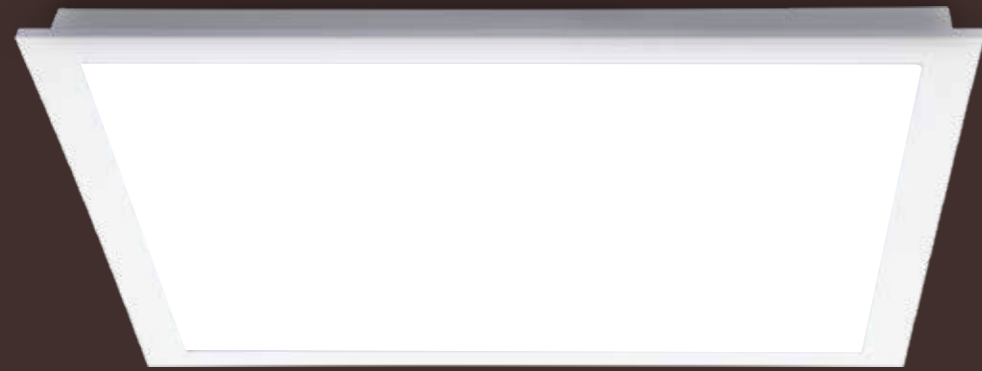

# VICINO SMART BACKLIT PANEL

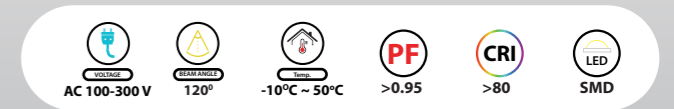

Product Code	Wattage	Voltage	Power Factor	System Luminous Efficacy	CRI	LED Light Source	Beam Angle	CCT	IP Rating	Surge Voltage	THD
LKM2240 SMA	40W	230V	>0.95	100 LM/W	>80	SMD	120°	2700K-6500K	IP20	4 KV	<10%

### Dimension (in mm)

PRODUCT CODE	LENGTH	WIDTH	HEIGHT	CUTOUT
LKM2240 SMA	595	595	35	570X570

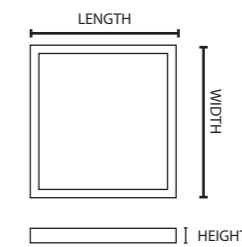

### Product Features

- Rated Life : 50000 Hrs
- Mounting Type : Recess Mounted
- Housing & Finish : Die Cast Aluminium + PC Diffuser

### Applications

Houses, Offices, Hospitals, Showrooms

### Smart Panel Features

- Light CCT tunable from 2700K - 6500K
- Dimmable smoothly from 100% - 10%
- Group Control function available to operate Multiple devices together
- Customised Off-Timer Function available

Download TUYA SMART LIFE / SMART LIFE app on Play Store & App Store





# SOLTERO COMMERCIAL LED SOLAR STREET LIGHT



# SOLTERO COMMERCIAL LED SOLAR STREET LIGHT

Product Code	LSTPSOL012	LSTPSOL018	LSTPSOL040
Wattage	12W	18W	40W
System Luminous Flux	1200 LM	1800 LM	4000 LM
Beam Angle	120°	120°	120°
CCT	6000-6500K	6000-6500K	6000-6500K
Battery Type	LifepO4,12.8V 6AH	LifepO4,12.8V 12AH	LifepO4,12.8V 24AH
Charging Time(by Sun)	7-8 Hrs	7-8 Hrs	7-8 Hrs
Backup Time	8-12 Hrs	8-12 Hrs	8-12 Hrs
Detection Range	12m Height With 75° Sensing Area	12m Height With 75° Sensing Area	12m Height With 75° Sensing Area
IP Rating	IP65	IP65	IP65
Solar Panel	18V 40W, POLYCRYSTALLINE	18V 50W, POLYCRYSTALLINE	18V 100W, POLYCRYSTALLINE
Sensor Available	PIR + Ambient Light Sensor	PIR + Ambient Light Sensor	PIR + Ambient Light Sensor
Dimesnsion	L:324MM, W:150MM, H:65MM	L:324MM, W:150MM, H:65MM	L:324MM, W:150MM, H:65MM
Pipe Dia	INSTALL Ø42MM	INSTALL Ø42MM	INSTALL Ø42MM
Solar Panel Dimension	670MM X 430MM X 33MM	L:324MM, W:150MM, H:65MM	L:522MM W:180MM H:80MM
Preferredd Mounting Height	4 TO 5 MTR	4 TO 5 MTR	5 TO 6 MTR
Rated Life	> 50,000 HOURS	> 50,000 HOURS	> 50,000 HOURS
Luminaire Body & Finish	DIE CAST ALUMINIUM BODY	DIE CAST ALUMINIUM BODY	DIE CAST ALUMINIUM BODY

- Solar streetlights will turn ON automatically in the absence of sunlight.
- Also it has Built-in PIR sensor for controlling the brightness. First 4 hours it glows with 100% brightness and thereafter goes into power saving mode-with 30% brightness.
- In power saving mode it will glow at 100% brightness (30 sec only) if any movement is detected within 12 meter radius.

