

**IMPROVING
LIVES**



PRICELIST

APRIL 2024



P. 15
DMX³ ACB from
630 A to 6300 A
fixed version

P. 16
DMX³ ACB from
630 A to 6300 A
draw out version

P. 18
Auxiliaries &
accessories



P. 24
DMX SP 2500 switch
disconnectors 630 A to
2500 A fixed version
draw-out version

P. 25
Auxiliaries &
accessories

P. 25
DMX SP 2500
protection units

Power



P. 59
DSX

P. 62-64
EMDX³
Digital meter

P. 66-68
PMX
Digital panel meter



P. 78-81
MPX³ & MPX³
accessories

P. 83
Alpx³ box type
capacitors standard
and heavy duty
440 V

P. 83
ALPX³ resin filled
capacitors standard
and heavy duty
440 V, 480 V & 525 V



P. 88-93
DX³ MCB
& isolators

P. 93-95
DX³ RCD
add-on module
with metering

P. 95
DX³ time switches
and contactors

**Protection,
Isolation,
Controlling,
Signalling,
Metering.**



P. 100
Time lag switches

P. 100
Lexic dimmer and
power contactors

P. 100
Lexic
time delay
relay



P. 106-107
Ekinox³
Phase selector neo DB,
TPN DB- 7/8 segment

P. 106
Ekinox³
SPN & ETPN DBs

P. 107-108
Ekinox³
TPN DB-
7 segment DBs

**Distribution
Boards**



P. 109
Ekinox³
Cable end box,
meter box, PPT Kit
& accessories

P. 110
Ekinox³ DBs
Plexo 3, boxes for
DX³ and accessories



P. 127
Square
white mechanism

P. 128-129
Square white mechanism, USB chargers,
data & voice, hotel functions, audio video,
energy plugs, USB charger, RJ 11 telephone
sockets, information outlets

**Arteor™
Wiring
Accessories**



P. 132-133
Square champagne mechanism, USB
chargers, data & voice, hotel functions, audio
video, energy plugs, USB charger, RJ 11
telephone sockets, information outlets

P. 133-134
Round white
mechanisms

**Arteor™
IoT**



P. 150
Arteor™
connected home

P. 150-151
White, magnesium & champagne mechanism-
connected light switches, outlets, gateway pack,
wireless controls & wireless scene switches



P. 19
Power supply

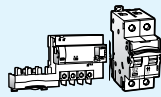

P. 20-22
E-communicating infrastructure

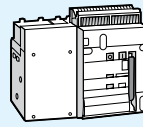

P. 24
DMX SP 2500 ACB
630 A to 2500 A
fixed version draw-out version



P. 28
DRX MCCBs

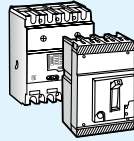

P. 29-43
DPX³ MCCBs & accessories

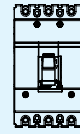

P. 46
DRX 125
MCCBs



P. 47-51
DRX 125,
250^{HP} & 630
MCCBs & accessories

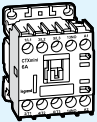

P. 70-72
CTX³ contactors

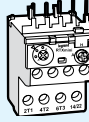

P. 73-74
RTX³
thermal relays

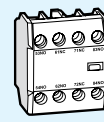

P. 75-76
CTX³
accessories



P. 83
Alpican gas filled
capacitors
heavy duty 440 V



P. 84
Reactors and
power factor
controllers

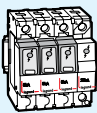

P. 96-99
SPD

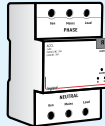

P. 99
ACCL

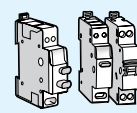

P. 99-100
DX3 changeover
switches,
push buttons and
indicators

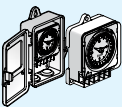

P. 101
Time switches and
accessories



P. 107
Ekinox³
TPN DB-VTPN



P. 109
Ekinox³
P17 Tempra plug
& socket DBs



P. 109
Ekinox³ metra plug
& socket DBs



P. 108-109
Ekinox³
metal
enclosures

NEW I

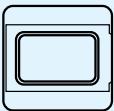

P. 110
Plexo-S DBs
and accessories

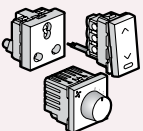

P. 129-130
Square
magnesium mechanism



P. 130-131
Square magnesium mechanism USB
chargers, data & voice, hotel functions,
audio video, energy plugs, USB
charger, RJ 11 telephone sockets,
information outlets

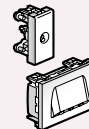

P. 131-132
Square
champagne mechanism

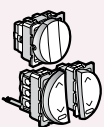

P. 134-135
Round magnesium+champagne
mechanism switches, push
buttons, dimmers & regulators,
plates, accessories

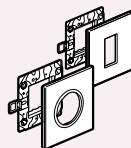

P. 135-142
Square cover plates,
round cover plates

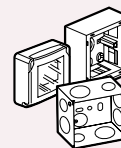

P. 142-143
Plastic surface,
metal flush boxes,
plexo boxes &
accessories



P. 151-154
Cover plates with and
without frame & accessories

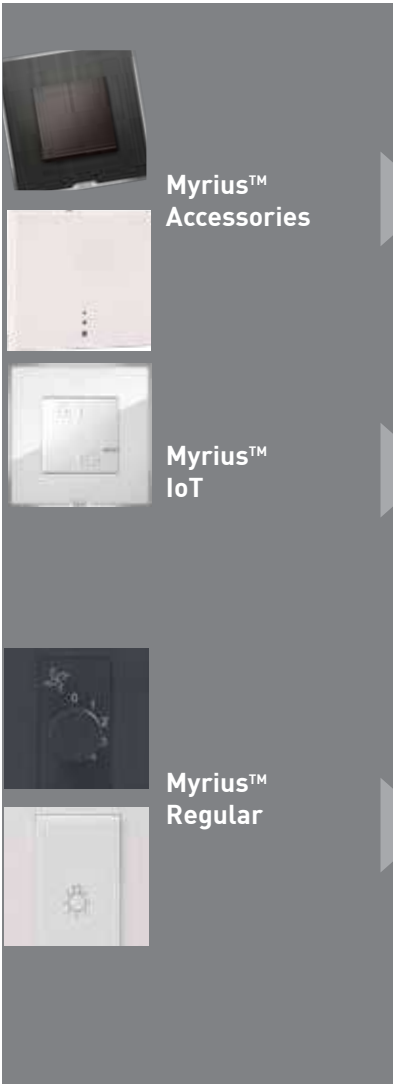

**Myrius™
Accessories**

**Myrius™
IoT**

**Myrius™
Regular**

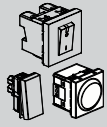

P. 162
Classic white switches,
push buttons, dimmers
& regulators, emergency
light

NEW!



P. 163-164
Hospitality functions,
sockets, electronic
function,
USB chargers

NEW!



P. 166-168
Plate with frame
White, ice white, ice black, pearl champagne,
sonic silver, dark fade, interlude, trinity, luminar,
stellar, ice silk & ice graphite

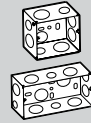

P. 169
Metal flush boxes

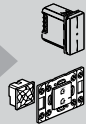

P. 174-175
Connected home white & charcoal grey mechanism, light switches,
connected outlets, curtain/roller binder, gateway pack, wireless control,
wireless scene switches

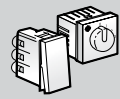

P. 184
White mechanism
switches, push buttons,
sockets, power units
and dimmer and
regulators



P. 184-185
Hospitality functions,
sockets, electronic
function & USB chargers

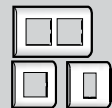

P. 188
White & black
plastic plates

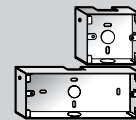

P. 189
Flush mounting &
surface boxes



**Mylinc™
Wiring
Accessories**

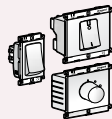

P. 193-194
White mechanism switches,
dimmers and accessories
USB charger and remote unit

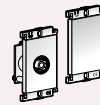

P. 193-194
White mechanism- TV
and RJ 11 telephone
sockets and accessories



P. 195
Matt grey mechanism



P. 196-197
Mylinc modular
plates- matt grey, pearl white,
champagne, silver alu, dark
bronze



**Lyncus™
Wiring
Accessories**



P. 201
White mechanism
switches, push buttons,
standard sockets

NEW!



P. 202
USB chargers



P.202
Dimmer and
regulators,
hospitality functions



P. 203
Chic grey mechanism- switches,
push buttons, dimmer and
regulators, accessories



P.203
Hospitality functions,
data voice, pre
terminated

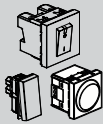

P. 164-165
Charcoal grey mechanisms, switches, push buttons, dimmers & regulators, emergency light

NEW!

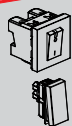

P. 165-166
Charcoal grey mechanisms, hospitality functions, sockets, electronic function, usb chargers



P. 166
Mechanism antibacterial & accessories



P. 169
Plastic surface boxes & metal surface boxes

NEW!



P. 175-179
Cover frame
White, ice white, ice black, pearl champagne, sonic silver, dark fade, interlude, trinity, luminar, stellar, ice silk & ice graphite



P. 178
Cover plates without frame & accessories

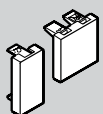

P. 185-186
Anti-Bacterial switches and accessories

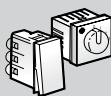

P. 186-187
Black mechanism-switches, push buttons, sockets, power units and dimmer and regulators

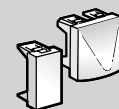

P. 187-188
Hospitality functions, sockets, electronic function, USB chargers

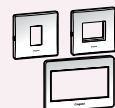

P. 194
Mylinc white modular plates

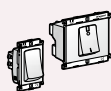

P. 194
Matt grey mechanism

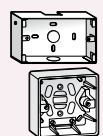

P. 197-198
Mylinc white surrounds, flush, plastic and surface boxes



P.202
Sound diffusion and loud speakers, universal dimmers, touch switches, reading lights



P.202
Data voice, pre terminated audio video connectors

NEW!



P. 203-204
Audio video connectors, USB chargers

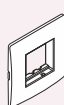

P. 204-206
Plate & frame white, chic grey, brushed silver, alu sunset, champagne, matt silver

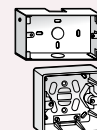

P. 207
Metal flush box & plastic surface boxes

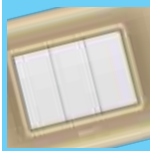

Allzy Wiring Accessories

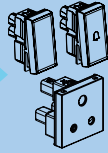

P. 212
White mechanisms - switches, sockets & dimmer and fan regulators

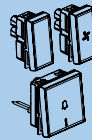

P. 212-213
White mechanisms - hospitality functions, sockets & connectors and protectors and accessories



Britzy™ Wiring Accessories

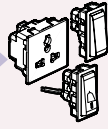

P. 218
Switches, sockets and push buttons

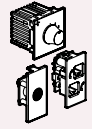

P. 218
Data & voice, television sockets, dimmers & regulators & accessories



Cable Management System and Accessories

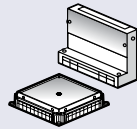

P. 232
Raceways & junction boxes for screed floors PVC, metal and accessories

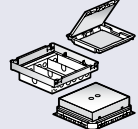

P. 233-238
Floor boxes for raised floor, screed floor and tile/marble, support plates



P. 235
Selection chart: concrete floor

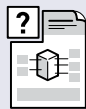

P. 245
Selection chart: DLP mini trunking systems

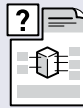

P. 246-247
Selection chart : DLP aluminium Trunking system

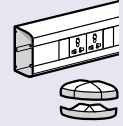

P. 248-249
Snap-on trunking 45 mm, routing sections and accessories



VDI Structured Cabling

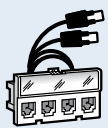

P. 256
LCS³, cat. 8 patch panels

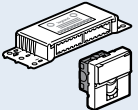

P. 256
LCS³, cat. 8 cables and cords

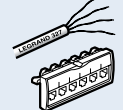

P. 256-260
LCS³, cat. 6A patch panels, RJ 45, cables and cords

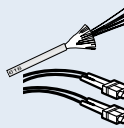

P. 266
LCS³, audio/video patch panel chord cables

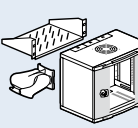

P. 267-269
Modular panels cassettes for LCS³ fibre optic drawers

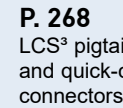

P. 268
LCS³ pigtailed, case and quick-connect connectors



Movement Detectors and Door Phones



P. 275
Movement detectors



P. 275
Video door entry system



P17 Tempra Pro, Hypra and Plugs & Sockets



P. 282-283
P17 Tempra Pro sockets

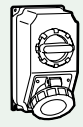

P. 283
P17 Tempra Pro for refrigerated container

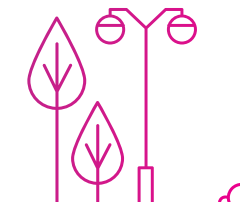
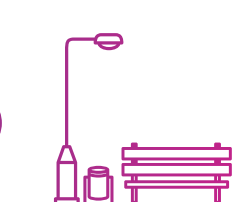

NEW

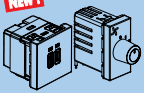

P. 212
White mechanisms -
electronic functions

NEW

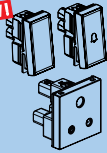

P. 213-214
Matt black mechanisms- switches, sockets
& dimmer and fan regulators, electronic
duntions, hospitality functions, sockets &
connectors and protectors and accessories

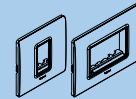

P. 214-215
Plate, frame,
boxes, flush
metal box and
surface box

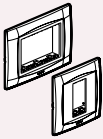

P. 219-220
white plate, warm orange silver,
herb beige, urban bronze, orange
chrome with frame

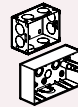

P. 220
Flush & surface
mounting boxes

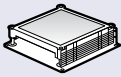

P. 234
Universal floor box,
heavy duty in-screed
floor box, floor boxes
3 module, floor access
unit for raised floors

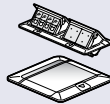

P. 238
Pop-up type
flush- mounting
boxes, power & data
desk grommets



P. 242-243
Selection chart:
Snap-on trunking



P. 244-245
Selection chart:
DLP PVC
adaptable trunking
system

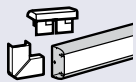

P. 248-249
DLP PVC trunking
system, trunking,
mini-trunking and
accessories

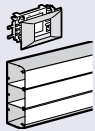

P. 250
DLP-S
PVC trunking
system and trunking
accessories

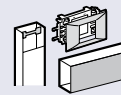

P. 250-251
DLP aluminium
adaptable trunking
system, aluminum
snap-on columns

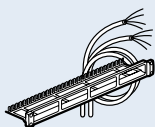

P. 263-264
LCS³,
cat. 5E patch
panels, cables
and cords, RJ 45

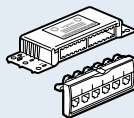

P. 264
LCS³,
cat. Splitter
sockets, adapters
and accessories

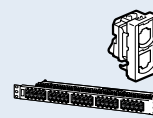

P. 265
LCS³, audio/video
preterminated
sockets

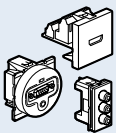

P. 270
9" fibre optic
drawers, LCS³
fibre optic blocks

P. 271
Patch chords



P. 284
Hypra industrial
plugs and sockets



Intelligent EI

SMARTNESS THAT MAKES A DIFFERENCE

Our Intelligent EI is a fully interconnected electrical system that enables reliable delivery of energy to customers through real-time, automated control systems. An overlay of information-oriented software and services on top of the existing infrastructure provides more reasons and opportunities for customer participation to make informed decisions and better operational efficiency.

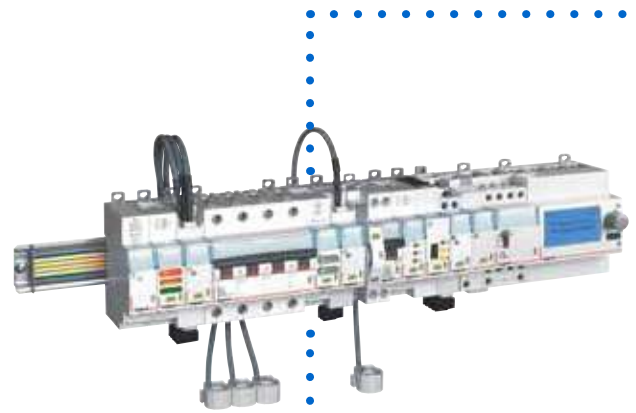

**PROGRAMMING
AND DISPLAY**



COMMUNICATION



MEASUREMENT



SIGNALLING



CONTROL



Scan to know more about the product.



**SIGNALLING
AND CONTROL**



CX³

A SMART PLATFORM FOR YOUR ENERGY MANAGEMENT NEEDS

The CX³ EMS energy management system allows the precise management and use of energy within a building. It allows full control of all activities and help supervises facility more effectively.



WEBSERVER



ACBs



MCCB'S



MEASURING UNIT



WATER



GAS



Scan to know more about the product.



3RD PARTY BMS/SCADA

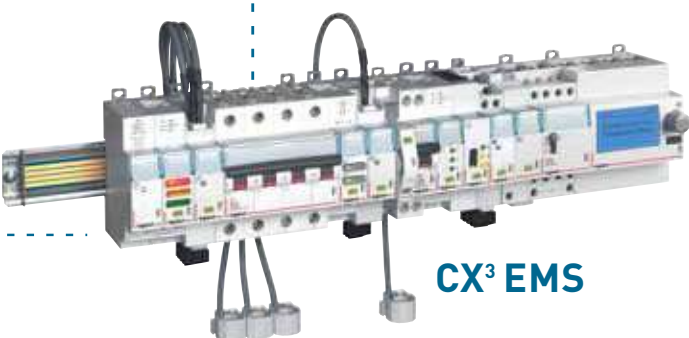

CX³ EMS



ENERGY
METER



ELECTRICITY

XL³ DO

FUTURE READY
ENCLOSURES DESIGNED
TO OUTPERFORM
ALL CONDITIONS

6300A
Integrated Switchboard Solutions



Scan to know more about
the product.

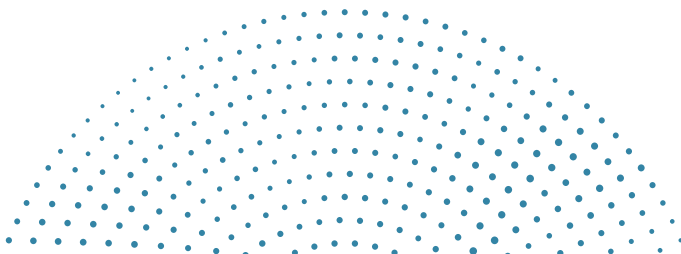

Advantages with XL3 DO:



Design verified assembly in accordance with IEC 61439, guarantees safe investment.



Internal arc withstand ensures additional personal safety.



Design Ambient of 50°C to withstand the harsh Indian conditions.



Available in IP43/54 configuration ensures further safety.



Be Connected and take control through communication capable products.



Sufficient cabling space with real front access foresees maintenance.



The wide choice of columns offers an unlimited number of XL3 DO enclosure configurations, so you can optimise and adapt your solutions to different types of environment.



Compact solution guarantees space saving.

AIR CIRCUIT BREAKERS

DMX³

EFFICIENT
PROTECTION
UP TO 6300 A



MP6 LSI/LSI_g TOUCH SCREEN PROTECTION UNIT



LEDs INDICATING CORRECT
OPERATION, PRE-ALARM
AND ALARM FOR OVERLOAD
AND TEMPERATURE

SETTINGS LOCK

ON BUTTON

MINI USB
PORT FOR PC
CONNECTION

Innovative and user friendly touch screen tripping units



Scan to know more about
the product.

DMX³ air circuit breakers



- Range – 630 A to 6300 A
- Three Optimum Frame Sizes
- Breaking Capacities of 50 kA, 65 kA & 100 kA
- Advanced Self Powered Electronic Protection Units
- Options for LSI and LSIG Trip Units
 - L : Ir – 0.4 to 1 In , tr – 5 to 30 sec
 - S : Isd – 1.5 to 10 Ir , tsd – 0.1 to 1 sec
 - I : Ii – 2 to 15 In
 - G : 0.2 to 1 In , tg – 0.1 to 1 sec
- Options of LCD and Touch Screen Multi Colour Displays
- Neutral Overload Protection – OFF-50 %-100 %
- Communication Ready
- In Built Temperature Protection
- Rotatable Terminals for Horizontal/Vertical Orientation
- Fast Operation
- Options to install various safety interlock
- Internal Battery for Trip Units
- Individual fault diagnosis
- Individual Fault Counter & Historical Trip Record
- Option to add 6 Programmable Digital Relay Contacts with Time Delay Changeover
- Option to Measure Current, Voltage, Frequency, Power, Energy, Power Factor and internal battery voltage
- Advanced Functions of Logical Selectivity, Reverse Power, Current Unbalance, Overvoltage, Undervoltage, Voltage Unbalance, Under Frequency, Over Frequency & Phase Reversal

Type and frame size	Rated Current (A)	3P			4P		
		Cat.Nos	MRP*/₹/Unit	Pack	Cat.Nos	MRP*/₹/Unit	Pack

Fixed version

DMX ³ - N 2500, Icu 50 kA Frame - 1	630 A	0286 20	■	1	0286 30	■	1
	800 A	0286 21	■	1	0286 31	■	1
	1000 A	0286 22	■	1	0286 32	■	1
	1250 A	0286 23	■	1	0286 33	■	1
	1600 A	0286 24	■	1	0286 34	■	1
	2000 A	0286 25	■	1	0286 35	■	1
	2500 A	0286 26	■	1	0286 36	■	1
DMX ³ -N 4000 Icu 50 kA Frame - 2	3200 A	0286 27	■	1	0286 37	■	1
	4000 A	0286 28	■	1	0286 38	■	1
DMX ³ - H 2500, Icu 65 kA Frame - 1	630 A	0286 40	■	1	0286 50	■	1
	800 A	0286 41	■	1	0286 51	■	1
	1000 A	0286 42	■	1	0286 52	■	1
	1250 A	0286 43	■	1	0286 53	■	1
	1600 A	0286 44	■	1	0286 54	■	1
	2000 A	0286 45	■	1	0286 55	■	1
	2500 A	0286 46	■	1	0286 56	■	1
DMX ³ -H 4000 Icu 65 kA Frame - 2	3200 A	0286 47	■	1	0286 57	■	1
	4000 A	0286 48	■	1	0286 58	■	1
DMX ³ - L 2500, Icu 100 kA Frame - 2	630 A	0286 60	■	1	0286 70	■	1
	800 A	0286 61	■	1	0286 71	■	1
	1000 A	0286 62	■	1	0286 72	■	1
	1250 A	0286 63	■	1	0286 73	■	1
	1600 A	0286 64	■	1	0286 74	■	1
	2000 A	0286 65	■	1	0286 75	■	1
	2500 A	0286 66	■	1	0286 76	■	1
DMX ³ -L 4000 Icu 100 kA Frame - 2	3200 A	0286 67	■	1	0286 77	■	1
	4000 A	0286 68	■	1	0286 78	■	1
DMX ³ -L 6300 Icu 100 kA Frame - 3	5000 A	0289 50	■	1	0289 60	■	1
	6300 A	0289 51	■	1	0289 61	■	1

■ Price available on request.

* MRP - Maximum Retail Price Inclusive of all taxes including GST.

Bold Cat.Nos are products normally available with Legrand (India) Stockists. Cat.Nos that are not bold - delivery within 4 - 8 weeks from the date of order. **Bold packing quantity** is our mandatory packing. Orders to be placed by Legrand (India) Stockist in multiples of the same.



0286 37



0286 56

DMX³ air circuit breakers

Type and frame size	Rated Current (A)	3P			4P		
		Cat.Nos	MRP*/₹/Unit	Pack	Cat.Nos	MRP*/₹/Unit	Pack
Draw - out version							
DMX ³ - N 2500, Icu 50 kA Frame - 1	630 A	0287 20	■	1	0287 30	■	1
	800 A	0287 21	■	1	0287 31	■	1
	1000 A	0287 22	■	1	0287 32	■	1
	1250 A	0287 23	■	1	0287 33	■	1
	1600 A	0287 24	■	1	0287 34	■	1
	2000 A	0287 25	■	1	0287 35	■	1
	2500 A	0287 26	■	1	0287 36	■	1
DMX ³ -N 4000 Icu 50 kA Frame - 2	3200 A	0287 27	■	1	0287 37	■	1
	4000 A	0287 28	■	1	0287 38	■	1
DMX ³ - H 2500, Icu 65 kA Frame - 1	630 A	0287 40	■	1	0287 50	■	1
	800 A	0287 41	■	1	0287 51	■	1
	1000 A	0287 42	■	1	0287 52	■	1
	1250 A	0287 43	■	1	0287 53	■	1
	1600 A	0287 44	■	1	0287 54	■	1
	2000 A	0287 45	■	1	0287 55	■	1
	2500 A	0287 46	■	1	0287 56	■	1
DMX ³ -H 4000 Icu 65 kA Frame - 2	3200 A	0287 47	■	1	0287 57	■	1
	4000 A	0287 48	■	1	0287 58	■	1
DMX ³ - L 2500, Icu 100 kA Frame - 2	630 A	0287 60	■	1	0287 70	■	1
	800 A	0287 61	■	1	0287 71	■	1
	1000 A	0287 62	■	1	0287 72	■	1
	1250 A	0287 63	■	1	0287 73	■	1
	1600 A	0287 64	■	1	0287 74	■	1
	2000 A	0287 65	■	1	0287 75	■	1
	2500 A	0287 66	■	1	0287 76	■	1
DMX ³ -L 4000 Icu 100 kA Frame - 2	3200 A	0287 67	■	1	0287 77	■	1
	4000 A	0287 68	■	1	0287 78	■	1
DMX ³ -L 6300 Icu 100 kA Frame - 3	5000 A	0289 52	■	1	0289 62	■	1
	6300 A	0289 53	■	1	0289 63	■	1



0287 56

switch disconnecter (trip free switches) from 1250 to 6300 A

Fixed version

DMX ³ -I 2500 Frame - 1	1250 A	0286 83	■	1	0286 93	■	1
	1600 A	0286 84	■	1	0286 94	■	1
	2000 A	0286 85	■	1	0286 95	■	1
	2500 A	0286 86	■	1	0286 96	■	1
DMX ³ -I 4000 Frame - 2	3200 A	0286 87	■	1	0286 97	■	1
	4000 A	0286 88	■	1	0286 98	■	1
DMX ³ -I 6300 Frame - 3	6300 A	0289 70	■	1	0289 71	■	1



0286 96

draw - out version

DMX ³ -I 2500 Frame - 1	1250 A	0287 83	■	1	0287 93	■	1
	1600 A	0287 84	■	1	0287 94	■	1
	2000 A	0287 85	■	1	0287 95	■	1
	2500 A	0287 86	■	1	0287 96	■	1
DMX ³ -I 4000 Frame - 2	3200 A	0287 87	■	1	0287 97	■	1
	4000 A	0287 88	■	1	0287 98	■	1
DMX ³ -I 6300 Frame - 3	6300 A	0289 77	■	1	0289 78	■	1



0287 96

* MRP - Maximum Retail Price Inclusive of all taxes including GST.
■ Price available on request.

Bold Cat.Nos are products normally available with Legrand (India) Stockists.
Cat.Nos that are not bold - delivery within 4 - 8 weeks from the date of order.
Bold packing quantity is our mandatory packing. Orders to be placed by Legrand (India) Stockist in multiples of the same.

DMX³

electronic protection units

Cat.Nos	Description	MRP*/₹/Unit	Pack
---------	-------------	-------------	------

Electronic protection units MP4

0288 01	Electronic Protection Unit with LCD screen with Im, tm, lr, tr and li adjustments on the front	■	1
0288 02	Electronic Protection Unit with LCD screen with Im, tm, lr, tr, li, lg and tg adjustments on the front	■	1



0288 02

Electronic protection units MP6

0288 03	Electronic Protection Unit with Touch screen with Im, tm, lr, tr and li, adjustments on the front	■	1
0288 04	Electronic Protection Unit with Touch screen with Im, tm, lr, tr, li, lg and tg adjustments on the front	■	1



0288 03

Accessories for electronic protection units

0288 10	External neutral CT for DMX ³ 6300	■	1
0288 11 ⁽¹⁾	External neutral CT	■	1

Type and frame size	3P			4P		
	Cat.Nos	MRP*/₹/Unit	Pack	Cat.Nos	MRP*/₹/Unit	Pack

Fixed version

DMX ³ 2500, fixed version, frame - 1	0288 84	■	1	0288 85	■	1
	0288 82	■	1	0288 83	■	1
DMX ³ 4000, DMX ³ 6300 fixed version, frame - 2 & 3	0288 92	■	1	0288 93	■	1
DMX ³ 2500 draw-out version, Frame - 1	0288 96	■	1	0288 97	■	1
DMX ³ 4000, DMX ³ 6300 draw-out version, fram - 2 & 3	0288 94	■	1	0288 95	■	1
DMX ³ 2500, draw-out version, frame-1 suitable for Aluminium	0288 96A	■	1	0288 97A	■	1
DMX ³ 4000, DMX ³ 6300 draw-out version, frame - 2&3, suitable for Aluminium	0288 94A	■	1	0288 95A	■	1



0288 84



0288 82

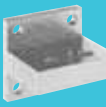

0288 96

Spreaders

DMX ³ 2500, fixed version, frame - 1	0289 02	■	1	0288 87	■	1
	0288 88	■	1	0288 89	■	1
	0288 90	■	1	0288 91	■	1



0288 91

Equipment for conversion of a fixed device into draw-out device

Bases (cradle) for Draw-Out Device

DMX ³ /DMX ³ -I 2500, frame - 1	0289 02	■	1	0289 03	■	1
DMX ³ /DMX ³ -I 4000, frame - 2	0289 04	■	1	0289 05	■	1
DMX ³ /DMX ³ -I 6300, frame - 3	0289 13	■	1	0289 14	■	1

Transformation kit for Draw-Out Version

DMX ³ /DMX ³ -I 2500, frame - 1	0289 09	■	1	0289 10	■	1
DMX ³ /DMX ³ -I 4000, frame - 2	0289 11	■	1	0289 12	■	1
DMX ³ /DMX ³ -I 6300, frame - 3	0289 15	■	1	0289 16	■	1

* MRP - Maximum Retail Price inclusive of all taxes including GST.

■ Price available on request.

(1) Optional accessories to be ordered while ordering electronic protection unit and DMX³ air circuit breakers for factory assembly

Bold Cat.Nos are products normally available with Legrand (India) Stockists. Cat.Nos that are not bold - delivery within 4 - 8 weeks from the date of order. Bold packing quantity is our mandatory packing. Orders to be placed by Legrand (India) Stockist in multiples of the same.

DMX³ auxiliaries and accessories

Cat.Nos	Description	MRP* ₹ / Unit	Pack
---------	-------------	------------------	------

Control and signalling auxiliaries

Shunt trip

0288 48	24 V~/=	■	1
0288 49	48 V~/=	■	1
0288 50	110 V~/=	■	1
0288 51	230 V~/=	■	1
0288 52	415 V~	■	1



0288 51

Undervoltage releases

0288 55	24 V~/=	■	1
0288 56	48 V~/=	■	1
0288 57	110 V~/=	■	1
0288 58	230 V~/=	■	1
0288 59	415 V~	■	1



0288 58

Undervoltage releases with delay

0288 62	110 V~/=	■	1
0288 63	230 V~/=	■	1

Motor operators

0288 34	24 V~/=	■	1
0288 35	48 V~/=	■	1
0288 36	110 V~/=	■	1
0288 37	230 V~/=	■	1
0288 38	415 V~	■	1



0288 37

Closing coils

0288 41	24 V~/=	■	1
0288 42	48 V~/=	■	1
0288 43	110 V~/=	■	1
0288 44	230 V~/=	■	1
0288 45	415 V~	■	1



0288 44

Locking

Key locking in "open" position

0288 27	Open position lock RONIS x 5 + 3 keys (Random)	■	1
0288 28	2 hole support frame for RONIS locks	■	1
4238 80	Key barrel and flat key with random mapping	■	1
4238 81	Key barrel and flat key with fixed mapping	■	1
4238 82	Key barrel and flat key with fixed mapping	■	1
4238 83	Key barrel and star key with random mapping	■	1
0281 94	Kit for key lock in d/o position DMX3	■	1

* MRP - Maximum Retail Price Inclusive of all taxes including GST.

■ Price available on request.

▼ For communication add 4226 82 + 4226 89

DMX³ auxiliaries and accessories

Cat.Nos	Description	MRP* ₹ / Unit	Pack
---------	-------------	------------------	------

Locking

Key locking in the draw out position

4238 80	Key Lock (Only lock + key)	■	1
4238 83	Key barrel and star key with random mapping	■	1
0281 94	Kit for key lock in d/o position DMX3	■	1



Door locking

0288 20	Left-hand and right-hand side mounting	■	1
---------	--	---	---

Padlocks in "open" position

0288 21	Padlocking system for ACB	■	1
0288 24	Padlocking for button	■	1
0288 26	Padlocking system for shutters	■	1

Automation control unit

4226 81	Standard unit	■	1
4226 82	Advanced unit	■	1
4226 89▼	Communication module	■	1



4226 82

Equipment for supply invertors

0288 64	Interlock for DMX ³ 2500	■	1
0288 65	Interlock for DMX ³ 4000	■	1
0288 66	Interlock for DMX ³ 6300	■	1



0288 64

Cable interlock

0289 20	Type 1 (2600 mm)	■	1
0289 21	Type 2 (3000 mm)	■	1
0289 22	Type 3 (3600 mm)	■	1
0289 23	Type 4 (4000 mm)	■	1
0289 24	Type 5 (4600 mm)	■	1
0289 25	Type 6 (5600 mm)	■	1

Accessories

0288 25	Rating mis-insertion device	■	1
0288 23	Operations counter	■	1
0288 13	Inserted / test / Draw-out Contact	■	1
0288 14	Contact "ready to close" with charged springs	■	1
0288 15	Set of additional signalling contacts	■	1
0288 16	Signal Contact for Auxiliaries	■	1
0288 22	Door sealing IP 40	■	1
0288 79	Lifting plate	■	1

Bold Cat.Nos are products normally available with Legrand (India) Stockists. Cat.Nos that are not bold - delivery within 4 - 8 weeks from the date of order. Bold packing quantity is our mandatory packing. Orders to be placed by Legrand (India) Stockist in multiples of the same.

power supply

Cat.Nos	Description	MRP* ₹ / Unit	Pack
---------	-------------	------------------	------

Generic power supply for all your conversion needs from AC to DC

Features

Conform to standards UL 508, UL 60950, EN 61558-2-16 and IEC EN 60950-1, EN 55022 class B, EN 61000-3-2, EN 61000-3-3, EN 61000-6-2 and EN 61204-3

Operating frequency: 50/60 Hz

Output voltage present indicator

Output voltage adjustment potentiometer on front panel

Integrated short-circuit and overload protection

For mounting on a symmetrical rail depth 7.5 mm and 15 mm

1467 01	Single-ph swmodule powrsupl15W	5550	1
1467 11	Single-ph swmodule powrsupl24W	6012	1

* MRP - Maximum Retail Price Inclusive of all taxes including GST.
(1) Price in Meters; No of meters in Pack, Standard length 2 meters to be ordered in multiple of 2 meters.

power supply

Cat.Nos	Description	MRP* ₹ / Unit	Pack
---------	-------------	------------------	------



1467 21

1467 12	Single-ph swmodule powrsupl54W	6710	1
1467 21	SM POWER SUPPLY 24V - 15W	6252	1
1467 22	Single-ph swmodule powrsupl36W	6244	1
1467 23	Single-ph swmodule powrsupl60W	6824	1
1467 24	Single-ph swmodule powrsupl92W	7450	1

Bold Cat.Nos are products normally available with Legrand (India) Stockists. Cat.Nos that are not bold - delivery within 4 - 8 weeks from the date of order. Bold packing quantity is our mandatory packing. Orders to be placed by Legrand (India) Stockist in multiples of the same.

Switching Mode Power Supplies

single-phase

Generic power supply for all your conversion needs from AC to DC

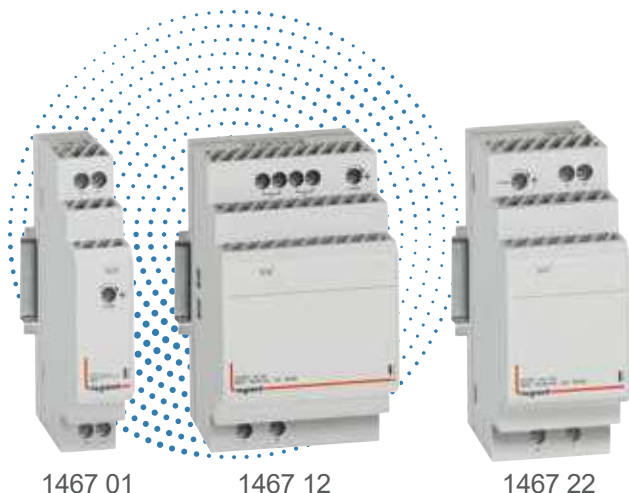

1467 01

1467 12

1467 22

UL 508 approvals

conforming to IES EN 60950-1, EN 61558-2-16

Conforming to EN 55022 class B*, EN 61000-3-2 class A, EN 61000-3-3

Conforming to EN 61000-4-2, 3, 4, 6 Level 3, criterion A

EN 61000-4-5 and 8 level 4, criterion A

EN 61204-3

*Class B means the power supply can be used in any environment, including residential

Features

Operating frequency: 50/60 Hz

Integrated short-circuit and overload protection on the power supply secondary

Class II insulation

Output voltage present indicator

Output voltage adjustment potentiometer on front panel

Output voltage variation: ±1%

No-load power consumption less than 0.3w

Cooling by natural convection

Modular product

COMMUNICATION ARCHITECTURE

PROTECTION

MEASUREMENT

CONTROL AND SIGNALLING

RESIDENTIAL

DX³ Ph+N MCBs



408614



408590

EMDX³ energy meters



4120 45



4120 81



4120 91



406295



406252



026136

Auxiliaries
and motorised
control

+

I/O interface

COLLECTIVE HOUSING AND
SMALL OFFICE BUILDINGS

DX3 MCBs



408614



408590

EMDX³ measuring
units



4120 53

EMDX³
energy
meters



4120 45 / 4120 81 / 4120 91



4106 57

Earth Leakage
Module with integrated
Measurement

Cx3 EMS modules:

414919
Single phase



414920
Three phase



414926
Pulse
concentrator

CX3 EMS
signalling and
control modules



414929



414930



414932

CX3 EMS signalling and
control modules



414931

COMMERCIAL AND INDUSTRIAL



420010

DPX3 MCCBs



028696

DMX3 MCCBs

EMDX³ measuring
units



4120 53



4120 45 / 4120 91
EMDX³ energy
meters

Auxiliaries and
motorised control

+

I/O interface



028815



026144



026136



414923

CX3 EMS
measuring
module

Auxiliaries and
motorised controls



028815



026144

+

CX3 EMS
signalling and
control modules



414929



414932

Electronic DPX3
with integrated
measurement



028803

DMX3 with
electronic
Protection unit

COMMUNICATION

REMOTE

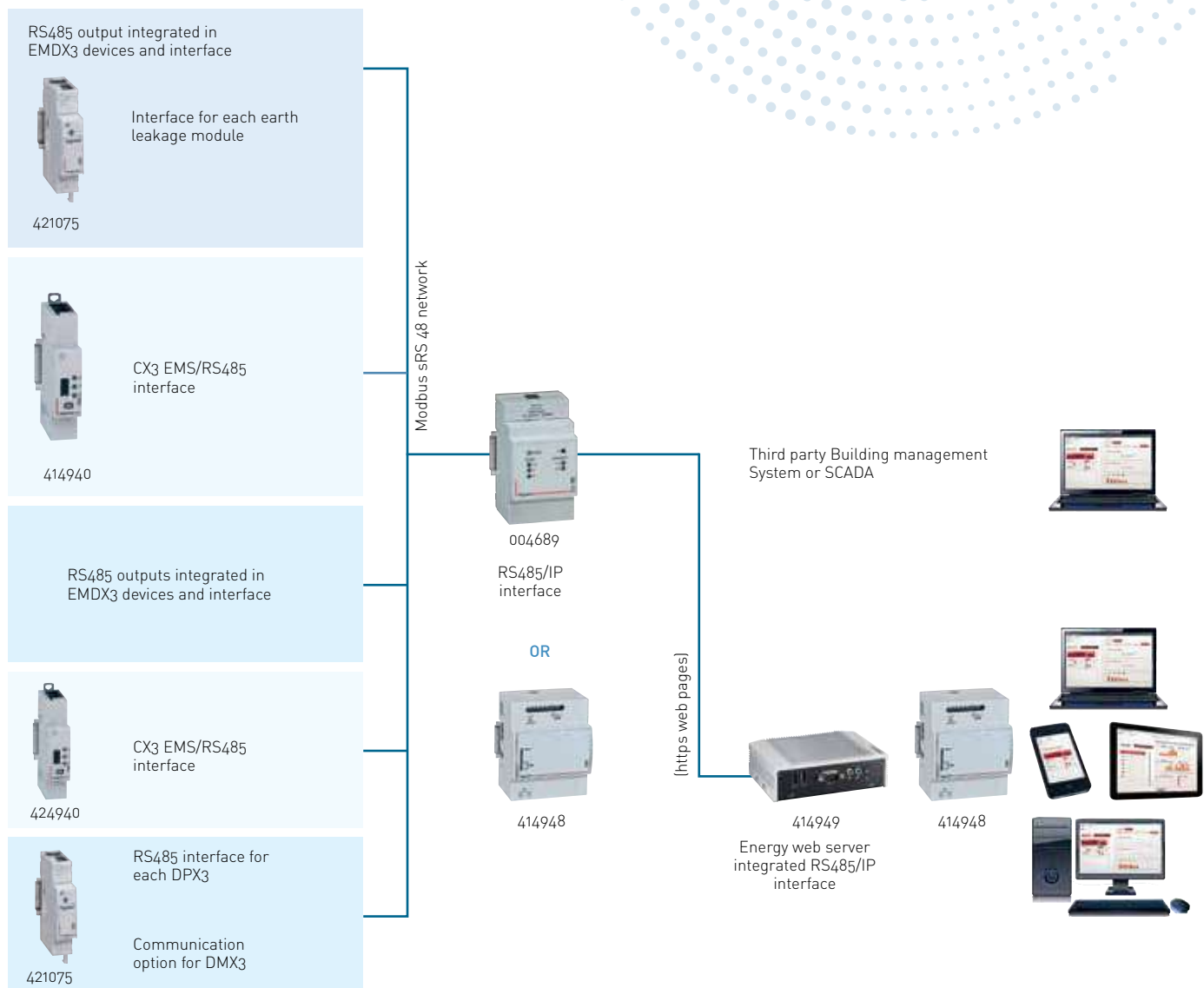

e-communicating infrastructure

Cat.Nos	Description	MRP* ₹ / Unit	Pack
---------	-------------	------------------	------

Power supervision system

Remote control, Monitoring and Measurement

Communication accessories for ACB

0288 05	Communication option - for DMX ³ electronic protection units (Factory Fitted)	3300	1
0288 06	Power supply - external - 12 V DC - for DMX ³ electronic protection units	6840	1

Communication modules

Modules programmable output

Features

Programmable electronic device capable of controlling 6 relay outputs. The device can work in three different ways, with DMX3, with DPX3 or as Independent module depending on the product it is associated with

6 Programmable relay outputs with 230 V, 8 A contacts

Communication is ensured by the Modbus protocol.

0288 12	Modules programmable output	30490	1
---------	-----------------------------	-------	---

Signalling and control interface

Features

Signalling and control interface between the power supervision system and the **thermal magnetic or electronic circuit breakers**.

Equipped with analogue / digital inputs and relay outputs.

Can handle multiple circuit breakers.

24 inputs for collecting information from the signalling auxiliaries on the DPX³ and DMX³ circuit breakers: auxiliary contact NO position (1 input) or NO+NC position (2 inputs), fault signal (1 input)

6 outputs for: the remote control of the motor driven circuit breakers (2 outputs) and for tripping the circuit breakers (1 output)

Communication is ensured by the Modbus protocol. Address, speed and coding can be modified with

configuration kit.

0261 36	Signalling and control interface	31760	1
---------	----------------------------------	-------	---

Communication accessories for MCCB

Features

RS485 communication interface

Potential free contact for circuit breaker tripped status information max. 220 V 0.2 A

4210 75	DPX ³ electronic interface For connecting electronic DPX ³ to an RS485 Modbus communication network Note: 24 V ₌ is required to power up the module	18390	1
4210 83	Auxiliary power supply for DPX ³ - 24 V _~ ± - 250 mA Can be used to power upto 8 breakers	5130	1

e-communicating infrastructure

Cat.Nos	Description	MRP* ₹ / Unit	Pack
---------	-------------	------------------	------

Communication accessories for MCB

Features

RS485 communication interface

Potential free contact for circuit breaker tripped status information max. 220 V 0.2 A

Can be connected with DX3 add on Modules (4106 57/58/59)

4210 75	DPX ³ electronic interface For connecting electronic DPX ³ to an RS485 Modbus communication network Note: 24 V ₌ is required to power up the module	18390	1
---------	---	-------	---

Communication accessories

0261 45	Configurator kit For configuring the DPX and DPX ³ I/O card and interface Kit with configurators 0 to 9 (10 configurators for each digit)	■	1
0046 89	IP converter For RS 485/ Ethernet conversion for connecting electricity meters and measurement control units to an IP network	■	1
1466 23	Stabilised switched modules power supply- single phase -75-960 W-output 24 V ₌ -120 W	■	1

Energy management multi-support web servers

Allow remote configuration, test, control and visualization, via a web browser on PCs, smartphones, web viewers, tablet computers, of data Converter

Features

In-built IP convertor

Power supply: 9 to 28 V₌ with the help of a single-phase switching mode power supply Cat.No 1467 21 to be ordered separately. With the Legrand Power supervision system, circuit breakers are integrated in a supervision system

You can therefore check the status of the circuit breakers, measure the electrical values and control the circuit breakers remotely.

MODBUS protocol

4149 47	For 10 Modbus addresses or 10 pulse modules	■	1
4149 48	For 32 Modbus addresses or 32 pulse modules	■	1
4149 49	For 255 Modbus addresses or 255 pulse modules Supplied with external power supply and fixing brackets	■	1

* MRP - Maximum Retail Price Inclusive of all taxes including GST.
(1) Price in Meters; No of meters in Pack, Standard length 2 meters to be ordered in multiple of 2 meters.

Bold Cat.Nos are products normally available with Legrand (India) Stockists. Cat.Nos that are not bold - delivery within 4 - 8 weeks from the date of order. Bold packing quantity is our mandatory packing. Orders to be placed by Legrand (India) Stockist in multiples of the same.

DMX

SP-2500

A SUPERIOR ACB IN
THE 630 A - 2500 A RANGE



With DMX-SP, Legrand offers you a new range of air circuit breakers and trip free switches that meet the performance requirements of any standard installation for current ratings up to 2500 A and breaking capacities up to 50 kA. Quality, reliability and strength are the main attributes of this new range, which provides effective protection for all your installations.

OPTIMIZED

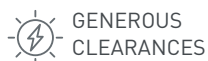

GENEROUS
CLEARANCES

SMART



ELECTRONIC RELEASES
OFFERING PRECISE
PROTECTION



IN - BUILT TEMPERATURE
PROTECTION

EFFICIENT



EASY INSTALLATION



EASY MAINTENANCE



Scan to know more about
the product.

DMX SP 2500 air circuit breakers



- Range – 630 A to 2500 A
- Single Frame Size
- Options of Fixed and Drawout Versions
- Options of Manual & Electrical Versions
- Icu=Ics=Icw(1s)=50 kA
- Compact Dimensions
- Advanced Self Powered Electronic Protection Units
 - MP2 & MP4
- MP2 - Electronic PU with LSI/LSIg + Neutral O/L + Over Temperature Protection
- MP4 - Electronic PU with LSI/LSIg + Neutral O/L + Over Temperature Protection
 - + LCD Display with Current Metering + 10 Trip History + 10 Alarms + Logical Selectivity
- Options of LSI and LSIG Protections
 - L : I_r – 0.4 to 1 I_n, t_r – 5 to 30 sec
 - S : I_{sd} – 1.5 to 10 I_r, t_{sd} – 0.1 to 1 sec
 - I : I_{li} – 2 to 15 I_n
 - G : I_g – 0.2 to 1 I_n, t_g – 0.1 to 1 sec
- Neutral Overload Protection - OFF-50 %-100 %
- In Built Temperature Protection
- Rotatable Terminals for Horizontal/Vertical Orientation
- Fast Operation
- Options to install various safety interlock



6695 26



6695 31

Type and frame size	Rated Current (A)	3P			4P		
		Cat.Nos	MRP*/₹/Unit	Pack	Cat.Nos	MRP*/₹/Unit	Pack

Fixed version

DMX SP 2500 Icu = 50 kA	630 A	6695 24	118720	1	6695 30	165370	1
	800 A	6695 25	118720	1	6695 31	165370	1
	1000 A	6695 26	127200	1	6695 32	178090	1
	1250 A	6695 27	150520	1	6695 33	207770	1
	1600 A	6695 28	174790	1	6695 34	228900	1
	2000 A	6695 29	209330	1	6695 35	275000	1
	2500 A	6695 76	265050	1	6695 77	308030	1

Drawout version

DMX SP 2500 Icu = 50 kA	630 A	6695 36	152640	1	6695 42	199280	1
	800 A	6695 37	152640	1	6695 43	199280	1
	1000 A	6695 38	161130	1	6695 44	212010	1
	1250 A	6695 39	184450	1	6695 45	241690	1
	1600 A	6695 40	208080	1	6695 46	262180	1
	2000 A	6695 41	258030	1	6695 47	306750	1
	2500 A	6695 78	300870	1	6695 79	358180	1

Switch disconnectors / trip free switches Fixed version

DMX SP 2500	630 A	6695 48	118720	1	6695 54	165370	1
	800 A	6695 49	118720	1	6695 55	165370	1
	1000 A	6695 50	127200	1	6695 56	178090	1
	1250 A	6695 51	150520	1	6695 57	207770	1
	1600 A	6695 52	174790	1	6695 58	228900	1
	2000 A	6695 53	209330	1	6695 59	275000	1
	2500 A	6695 80	265050	1	6695 81	308030	1

Drawout version

DMX SP 2500	630 A	6695 60	152640	1	6695 66	199280	1
	800 A	6695 61	152640	1	6695 67	199280	1
	1000 A	6695 62	161130	1	6695 68	212010	1
	1250 A	6695 63	184450	1	6695 69	241690	1
	1600 A	6695 64	208080	1	6695 70	262180	1
	2000 A	6695 65	258030	1	6695 71	306750	1
	2500 A	6695 82	300870	1	6695 83	358180	1

* MRP - Maximum Retail Price Inclusive of all taxes including GST.

Bold Cat.Nos are products normally available with Legrand (India) Stockists. Cat.Nos that are not bold - delivery within 4 - 8 weeks from the date of order. Bold packing quantity is our mandatory packing. Orders to be placed by Legrand (India) Stockist in multiples of the same.

DMX SP 2500

electronic protection units

Cat.Nos	Description	MRP* ₹ / Unit	Pack
---------	-------------	------------------	------

Electronic protection units

0281 67	Electronic Protection Unit MP2 LSI	26320	1
0281 68	Electronic Protection Unit MP2 LSIG	32390	1
0281 65	Electronic Protection Unit MP4 LSI	31990	1
0281 66	Electronic Protection Unit MP4 LSIG	39990	1

Auxillaries accessories

Motor operator

0281 20	24 V~/=	37330	1
0281 21	48 V~/=	37330	1
0281 22	110-130 V~/=	37330	1
0281 23	220-250 V~/=	37330	1
0281 24	415-440 V~	37330	1

Closing coil

0281 26	24 V~/=	6290	1
0281 27	48 V~/=	6290	1
0281 28	110-130 V~/=	6290	1
0281 29	220-250 V~/=	6290	1
0281 30	415-440 V~	6290	1

Shunt release

0281 31	24 V~/=	6290	1
0281 32	48 V~/=	6290	1
0281 33	110-130 V~/=	6290	1
0281 34	220-250 V~/=	6290	1
0281 35	415-440 V~	6290	1

Undervoltage release

0281 36	24 V~/=	8500	1
0281 37	48 V~/=	8500	1
0281 38	110-130 V~/=	8500	1
0281 39	220-250 V~/=	8500	1
0281 40	415-440 V~	8500	1

Time delay module for undervoltage release

0288 62	110 V~/=	■	1
0288 63	230 V~/=	7120	1

Mechanical accessories

Phase barriers / insulated shields

6696 00	Fix Version 3P DMX SP	■	1
6696 01	Fix Version 4P DMX SP	■	1
6696 02	Draw-out Version 3P DMX SP	2160	1
6696 03	Draw-out Version 4P DMX SP	2880	1

■ Price available on request.

* MRP - Maximum Retail Price Inclusive of all taxes including GST.

DMX SP 2500

auxillaries accessories

Cat.Nos	Description	MRP* ₹ / Unit	Pack
---------	-------------	------------------	------

Key lock open & drawout position

0288 91	Open & DO position lock	■	1
4238 80	Key lock (only lock+key)	■	1
4238 81	Key lock FIXED (only lock+key)	■	1
4238 82	Key lock FIXED (only lock+key)	■	1
4238 83	Keylock drawout - DMX SP	■	1
0281 84	Door lock for both right & left handle Frame 2500	5270	1
0281 87	Inserted/test/drawout lock button	2430	1

Terminals

0288 84	Real terminals - flat connections with bars-3P	20810	1
0288 82	Real terminals - vertical connections with bars-4P	23120	1
0288 85	Real terminals - flat connections with bars-3P	27050	1
0288 83	Real terminals - vertical connections with bars-4P	31210	1
0288 96	Real terminals - vertical or horizontal connection with bars to be fixed onto plate-3P	12580	1
0288 97	Real terminals - vertical or horizontal connection with bars to be fixed onto plate-4P	16780	1

Additional accessories

0281 88	Mechanical Counter	4050	1
0281 77	Padlock for Button	1610	1
6696 05	Enternal Neutral	7860	1
0281 73	Signalling Contact inserted-test-D/O	3170	1
0281 74	AUX Ready to close-charged springs	3240	1
0281 75	Module with 6 aux contacts	24290	1
0281 90	Mechanical Interlock two device	12990	1

Bold Cat.Nos are products normally available with Legrand (India) Stockists. Cat.Nos that are not bold - delivery within 4 - 8 weeks from the date of order. Bold packing quantity is our mandatory packing. Orders to be placed by Legrand (India) Stockist in multiples of the same.

DPX³

PRECISE PROTECTION
AND MEASUREMENT
UP TO 1600 A



TOTAL SELECTIVITY FOR OPTIMUM CONTINUITY OF SERVICE

DYNAMIC SELECTIVITY

Electronic DPX³ units have 2-position adjustment:

- Low for normal selectivity level
- High for high selectivity level

When electronic circuit breakers are set to High there is a slight tripping delay, enabling a high level of selectivity to be obtained, even for the highest short-circuit currents.

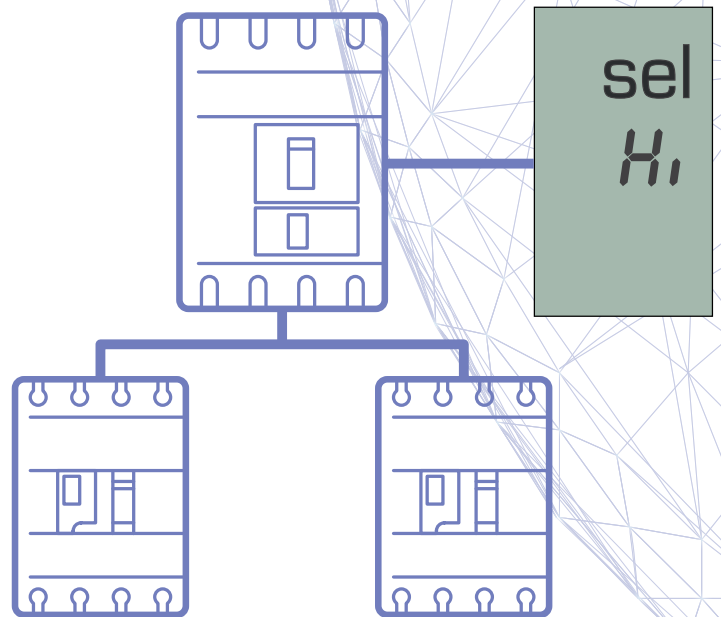

DPX³ 160



DPX³ 250



DPX³ 630



DPX³ 1600



Scan to know more about
the product.



NEW FUNCTIONS
TO SIMPLIFY USE

Integrated measurement From 40 to 1600 A

The measurement data can also be viewed remotely on a PC equipped with supervision software, via a communication interface.

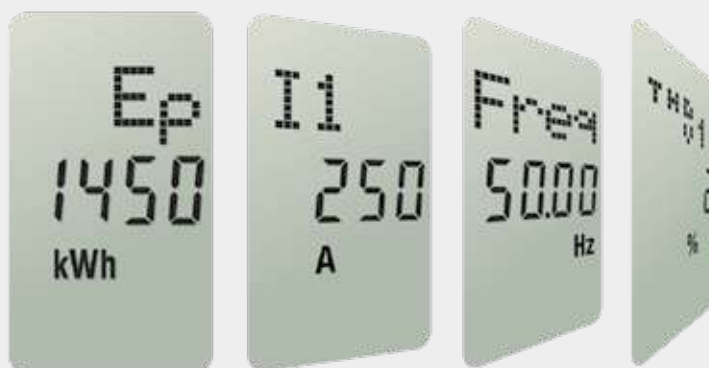

DRX™ MCCB

Type and frame size	Rated Current (A)	Poles	Cat.Nos	MRP* ₹ / Unit	Pack
---------------------	-------------------	-------	---------	---------------	------

DRX MCCBs

DRX 100 Icu = 10 kA	63 A	3 Pole	0270 39	3630	1/12
	75 A	3 Pole	0270 07	3630	1/12
	100 A	3 Pole	0270 08	3630	1/12
NEW!	125 A	3 Pole	0270 09	4770	1/12
NEW!	63 A	4 Pole	0270 29	5230	1/12
	75 A	4 Pole	0270 17	5230	1/12
	100 A	4 Pole	0270 18	5230	1/12
	125 A	4 Pole	0270 19	5620	1/12

Description	Cat.Nos	MRP* ₹ / Unit	Pack
-------------	---------	---------------	------

DIN rail adaptor

DRX 100	0271 87	500	1
---------	---------	-----	---

Rotary handles - direct

DRX 100	6687 70	1250	1
---------	---------	------	---

Rotary handles - vary-depth

DRX 100	6687 71	1910	1
---------	---------	------	---

Padlocking support for operating handle

DRX 100	0271 80	170	1
---------	---------	-----	---

Connection accessories

Set of 2 shields for 3 pole	0271 81	120	1
-----------------------------	---------	-----	---

Sealable terminal shields (moulded shrouds)

For DRX 100 - 3 pole	0271 83	1620	1
For DRX 100 - 4 pole	0271 84	1520	1

Cage terminals

For DRX 100 - 3 pole	0271 71	330	1
For DRX 100 - 4 pole	0271 73	310	1

Electrical accessories

Block with 1 auxiliary (1 AUX)	0271 40	1090	1
Block with 1 alarm (1 AL)	0271 41	1090	1
Block with 1 auxiliary + 1 alarm (1 AUX + 1 AL)	0271 42	1900	1

Current shunt coils

200/277 V~ and =	0271 54	2350	1
380/480 V~ and =	0271 55	2350	1

Undervoltage release coils

200/240 V~	0271 64	3260	1
380/415 V~	0271 65	3260	1

DRX spreader links

3 Links set for TP	6250 10	270	1
4 Links set for FP	6250 11	390	1

Metal one way enclosures for MCCB

Cat.Nos	Description	No. of modules	MRP* ₹ / Unit	Pack
5078 05	DRX 100 MCCB enclosure-TP	3	■	1
5078 06	DRX 100 MCCB enclosure-FP	3	■	1

* MRP - Maximum Retail Price Inclusive of all taxes including GST.

BUSBAR TRUNKING SYSTEM

FOR INDUSTRIAL, COMMERCIAL, RESIDENTIAL AND SERVICE SECTOR BUILDINGS

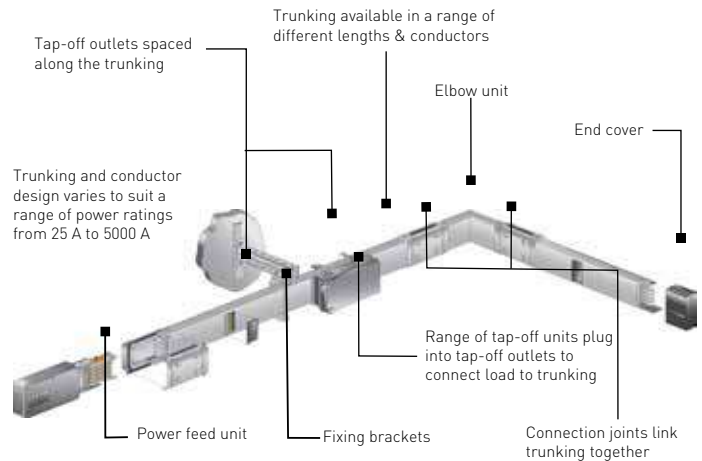

Exclusive features

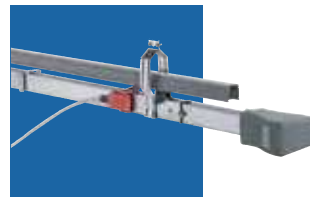

Low Power (25 A, 40 A, 63 A)

- Lighting busway
- 2, 4 & 6 pole
- IP 55 protection
- Tap off units at each 0.5 mt interval
- Copper busbars



Medium Power (63 A - 1000 A)

- Riser mains application
- IP 40, IP 52, IP 55 protection
- Tap off units at each 1 mt interval
- Aluminium & copper busbars



Cast Resin Busbar (630 A - 6300 A)

- Fully insulated with epoxy resin
- IP68 suited for outdoor
- Industrial plants, Petrochemical plants, Chemical plants in areas with risk of flooding.

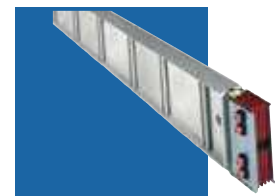

Super Compact (630 A - 6300 A)

- Sandwich type construction
- IP 65 protection
- Tap off boxes at each 1 mt interval
- Aluminium & copper busbars



Scan to know more about the product.

Bold Cat.Nos are products normally available with Legrand (India) Stockists. Cat.Nos that are not bold - delivery within 4 - 8 weeks from the date of order. Bold packing quantity is our mandatory packing. Orders to be placed by Legrand (India) Stockist in multiples of the same.

DPX³ MCCB

DPX³ MCCB with thermal magnetic protection unit

- Range: 16A – 1250A, Ics=100%Icu, Four Optimum Frames
 - Thermal Adjustable – 0.8 to 1In, Magnetic Adjustable** – 5 to 10In
 - Breaking Capacity# – 16kA, 25kA, 36kA, 50kA, 70kA & 100kA
 - Option for In built or add on module for Earth Leakage Protection##
 - Adjustable sensitivity: 0.03 - 0.3 - 1 - 3 A
 - Adjustable tripping: 0 - 0.3 - 1 - 3s
 - Suitable for Isolation
- ** Fixed at 10In for DPX³ 160
 # Refer Catalogue for frame wise data
 ## For DPX³ 160, DPX³ 250 and DPX³ 630 Only

Category	Type	Rated Current (A)	3P			4P		
			Cat.Nos	MRP*/₹/Unit	Pack	Cat.Nos	MRP*/₹/Unit	Pack

Thermal magnetic : O/L & S/C protection

16 KA	DPX ³ 160	16	4200 00	7590	1	4200 10	10110	1
		25	4200 01	7590	1	4200 11	10110	1
		40	4200 02	7590	1	4200 12	10110	1
		63	4200 03	7590	1	4200 13	10110	1
		80	4200 04	7590	1	4200 14	10110	1
		100	4200 05	7590	1	4200 15	10110	1
		125	4200 06	8210	1	4200 16	10180	1
		160	4200 07	10590	1	4200 17	13330	1
25 KA	DPX ³ 160	16	4200 40	8870	1	4200 50	12330	1
		25	4200 41	8870	1	4200 51	12330	1
		40	4200 42	8870	1	4200 52	12330	1
		63	4200 43	8870	1	4200 53	12330	1
		80	4200 44	8870	1	4200 54	12330	1
		100	4200 45	8870	1	4200 55	12330	1
		125	4200 46	12830	1	4200 56	15570	1
		160	4200 47	16680	1	4200 57	19830	1
	DPX ³ 250	200	4202 08	23040	1	4202 18	27840	1
		250	4202 09	26710	1	4202 19	36000	1
36 KA	DPX ³ 160	16	4200 80	11240	1	4200 90	14030	1
		25	4200 81	11240	1	4200 91	14030	1
		40	4200 82	11240	1	4200 92	14030	1
		63	4200 83	11240	1	4200 93	14030	1
		80	4200 84	11240	1	4200 94	14030	1
		100	4200 85	11240	1	4200 95	14030	1
		125	4200 86	13180	1	4200 96	17200	1
		160	4200 87	16980	1	4200 97	19990	1
	DPX ³ 250	200	4202 38	29040	1	4202 48	36720	1
		250	4202 39	32230	1	4202 49	39320	1
	DPX ³ 630	320	4220 01	38730	1	4220 06	43990	1
		400	4220 02	38730	1	4220 07	44950	1
		500	4220 03	46600	1	4220 08	55430	1
		630	4220 04	46600	1	4220 09	56850	1
	DPX ³ 1600	800	4222 52	71110	1	4222 57	82700	1
		1000	4222 53	90570	1	4222 58	117330	1
		1250	4222 54	129410	1	4222 59	141150	1

■ Price available on request.

* MRP - Maximum Retail Price Inclusive of all taxes including GST.

Bold Cat.Nos are products normally available with Legrand (India) Stockists. Cat.Nos that are not bold - delivery within 4 - 8 weeks from the date of order. Bold packing quantity is our mandatory packing. Orders to be placed by Legrand (India) Stockist in multiples of the same.

DPX³ MCCB

DPX³ MCCB with thermal magnetic protection unit

Category	Type	Rated Current (A)	3P			4P			
			Cat.Nos	MRP*/₹/Unit	Pack	Cat.Nos	MRP*/₹/Unit	Pack	
Thermal magnetic : O/L & S/C protection									
50 KA	DPX ³ 160	16	4201 20	14970	1	4201 30	18860	1	
		25	4201 21	14970	1	4201 31	18860	1	
		40	4201 22	14970	1	4201 32	18860	1	
		63	4201 23	14970	1	4201 33	18860	1	
		80	4201 24	14970	1	4201 34	18860	1	
		100	4201 25	14970	1	4201 35	18860	1	
		125	4201 26	19620	1	4201 36	22610	1	
		160	4201 27	22080	1	4201 37	25690	1	
	DPX ³ 250	200	4202 68	35190	1	4202 78	44460	1	
		250	4202 69	37150	1	4202 79	46240	1	
	DPX ³ 630	320	4220 15	42050	1	4220 20	51250	1	
		400	4220 16	42950	1	4220 21	51250	1	
		500	4220 17	53170	1	4220 22	67150	1	
		630	4220 18	53170	1	4220 23	68850	1	
	DPX ³ 1600	800	4222 64	78290	1	4222 69	97670	1	
		1000	4222 65	119170	1	4222 70	137860	1	
		1250	4222 66	175070	1	4222 71	183810	1	
	70 KA	DPX ³ 250	100	4206 05	30830	1	4206 15	34030	1
			160	4206 07	38520	1	4206 17	47890	1
			200	4206 08	47430	1	4206 18	58360	1
			250	4206 09	50400	1	4206 19	60750	1
DPX ³ 630		320	4220 29	49190	1	4220 34	60920	1	
		400	4220 30	49200	1	4220 35	60920	1	
		500	4220 31	64160	1	4220 36	82660	1	
		630	4220 32	67430	1	4220 37	82660	1	
DPX ³ 1600		800	4222 76	125130	1	4222 81	145070	1	
		1000	4222 77	187630	1	4222 82	265660	1	
		1250	4222 78	192220	1	4222 83	306340	1	

* MRP - Maximum Retail Price Inclusive of all taxes including GST.
 ■ Price available on request.

Bold Cat.Nos are products normally available with Legrand (India) Stockists. Cat.Nos that are not bold - delivery within 4 - 8 weeks from the date of order. Bold packing quantity is our mandatory packing. Orders to be placed by Legrand (India) Stockist in multiples of the same.

DPX³ MCCB

DPX³ MCCB with thermal magnetic protection unit

Category	Type	Rated Current (A)	3P			4P		
			Cat.Nos	MRP*/₹/Unit	Pack	Cat.Nos	MRP*/₹/Unit	Pack
Thermal magnetic + electronic earth leakage module								
16 KA	DPX ³ 160	16	-	-	-	4200 30	34150	1
		25	-	-	-	4200 31	34150	1
		40	-	-	-	4200 32	34150	1
		63	-	-	-	4200 33	34150	1
		80	-	-	-	4200 34	34150	1
		100	-	-	-	4200 35	34150	1
		125	-	-	-	4200 36	36020	1
		160	-	-	-	4200 37	45700	1
25 KA	DPX ³ 160	16	-	-	-	4200 70	43230	1
		25	-	-	-	4200 71	43230	1
		40	-	-	-	4200 72	43230	1
		63	-	-	-	4200 73	43230	1
		80	-	-	-	4200 74	43230	1
		100	-	-	-	4200 75	43230	1
		125	-	-	-	4200 76	43250	1
		160	-	-	-	4200 77	51060	1
	DPX ³ 250	100	-	-	-	4202 25	52120	1
		160	-	-	-	4202 27	54790	1
		200	-	-	-	4202 28	56910	1
		250	-	-	-	4202 29	60860	1
36 KA	DPX ³ 160	16	-	-	-	4201 10	52590	1
		25	-	-	-	4201 11	52590	1
		40	-	-	-	4201 12	52590	1
		63	-	-	-	4201 13	52590	1
		80	-	-	-	4201 14	52590	1
		100	-	-	-	4201 15	52590	1
		125	-	-	-	4201 16	52870	1
		160	-	-	-	4201 17	62890	1
	DPX ³ 250	100	-	-	-	4202 55	54410	1
		160	-	-	-	4202 57	63380	1
		200	-	-	-	4202 58	66470	1
		250	-	-	-	4202 59	71080	1
50 KA	DPX ³ 160	16	-	-	-	4201 50	60900	1
		25	-	-	-	4201 51	60900	1
		40	-	-	-	4201 52	60900	1
		63	-	-	-	4201 53	60900	1
		80	-	-	-	4201 54	60900	1
		100	-	-	-	4201 55	60900	1
		125	-	-	-	4201 56	64880	1
		160	-	-	-	4201 57	69440	1
	DPX ³ 250	100	-	-	-	4202 85	65290	1
		160	-	-	-	4202 87	75580	1
		200	-	-	-	4202 88	79630	1
		250	-	-	-	4202 89	84610	1

■ Price available on request.

* MRP - Maximum Retail Price Inclusive of all taxes including GST.

Bold Cat.Nos are products normally available with Legrand (India) Stockists. Cat.Nos that are not bold - delivery within 4 - 8 weeks from the date of order. Bold packing quantity is our mandatory packing. Orders to be placed by Legrand (India) Stockist in multiples of the same.

DPX³ MCCB

DPX³ MCCB with electronic S2[#] (LSI)[#] protection punit

- Range: 40A – 1600A, Ics=100%Icu, Three Optimum Frames
- Protection against overloads:
 - Ir adjustable from 0.4 to 1 x In
 - tr adjustable from 3 to 30s#
- Protection against short circuits:
 - Isd adjustable from 1.5 to 10 x Ir
 - tsd adjustable from 0 to 0.5s
- Inbuilt Instantaneous Protection:
 - li# – Fixed
- Option for In built or add on module for Earth Leakage Protection##
 - Adjustable sensitivity: 0.03 - 0.3 - 1 - 3 A
 - Adjustable tripping: 0 - 0.3 - 1 - 3s
- Breaking Capacity# – 25kA, 36kA, 50kA, 70kA & 100kA
- In built Display for Current Metering with accuracy of class 1
- Internal Battery with battery measure function
- Communication Ready via COMM Port
- Logical Selectivity Ready (Zone Selective Interlocking)
- Dynamic Selectivity as per Selectivity Charts
- In Built USB Port for Software Diagnosis
- Suitable for Isolation

Category	Type	Rated Current (A)	3P			4P		
			Cat.Nos	MRP*/₹/Unit	Pack	Cat.Nos	MRP*/₹/Unit	Pack

Electronic S2

25 KA	DPX ³ 250	40	4203 02	24580	1	4203 12	32280	1
		100	4203 05	24580	1	4203 15	32280	1
		160	4203 07	31850	1	4203 17	38090	1
		250	4203 09	41530	1	4203 19	51490	1
36 KA	DPX ³ 250	40	4203 32	26720	1	4203 42	32940	1
		100	4203 35	26720	1	4203 45	32940	1
		160	4203 37	33490	1	4203 47	44690	1
		250	4203 39	44870	1	4203 49	51630	1
	DPX ³ 630	320	4220 57	49350	1	4220 62	60310	1
		400	4220 58	49350	1	4220 63	60310	1
		500	4220 59	55220	1	4220 64	74070	1
		630	4220 60	56370	1	4220 65	75630	1
DPX ³ 1600	800	4223 00	94380	1	4223 06	112600	1	
	1000	4223 01	141020	1	4223 07	208090	1	
	1250	4223 02	169920	1	4223 08	253100	1	
	1600	4223 03	210290	1	4223 09	282460	1	
50 KA	DPX ³ 250	40	4203 62	31770	1	4203 72	42340	1
		100	4203 65	31770	1	4203 75	41650	1
		160	4203 67	38360	1	4203 77	45800	1
		250	4203 69	51180	1	4203 79	61950	1
	DPX ³ 630	320	4220 67	56030	1	4220 72	71470	1
		400	4220 68	56030	1	4220 73	71470	1
		500	4220 69	65470	1	4220 74	81850	1
		630	4220 70	65470	1	4220 75	81850	1
	DPX ³ 1600	800	4223 12	108510	1	4223 18	133280	1
		1000	4223 13	150930	1	4223 19	210350	1
		1250	4223 14	183150	1	4223 20	266960	1
		1600	4223 15	256500	1	4223 21	301960	1

* MRP - Maximum Retail Price Inclusive of all taxes including GST.
 ■ Price available on request.

Bold Cat.Nos are products normally available with Legrand (India) Stockists.
 Cat.Nos that are not bold - delivery within 4 - 8 weeks from the date of order.
 Bold packing quantity is our mandatory packing. Orders to be placed by Legrand (India) Stockist in multiples of the same.

DPX³ MCCB

DPX³ MCCB with electronic S2[#] (LSI)^{*} protection unit

Category	Type	Rated Current (A)	3P			4P		
			Cat.Nos	MRP*/₹/Unit	Pack	Cat.Nos	MRP*/₹/Unit	Pack

Electronic S2

70 KA	DPX ³ 250	40	4206 35	40180	1	4206 45	53150	1
		100	4206 37	40580	1	4206 47	53150	1
		160	4206 38	53150	1	4206 48	61050	1
		250	4206 39	60680	1	4206 49	78310	1
	DPX ³ 630	320	4220 77	71040	1	4220 82	91700	1
		400	4220 78	71040	1	4220 83	91700	1
		500	4220 79	80830	1	4220 84	103080	1
		630	4220 80	80830	1	4220 85	103080	1
	DPX ³ 1600	800	4223 24	141570	1	4223 30	179160	1
		1000	4223 25	198390	1	4223 31	283140	1
		1250	4223 26	237580	1	4223 32	330320	1
		1600	4223 27	319380	1	4223 33	393230	1

Electronic S2 + electronic earth leakage module

25 kA	DPX ³ 250	40	-	-	-	4203 22	73740	1
		100	-	-	-	4203 25	73380	1
		160	-	-	-	4203 27	78720	1
		250	-	-	-	4203 29	92570	1
36 kA	DPX ³ 250	40	-	-	-	4203 52	76650	1
		100	-	-	-	4203 55	76650	1
		160	-	-	-	4203 57	84350	1
		250	-	-	-	4203 59	98590	1
50 kA	DPX ³ 250	40	-	-	-	4203 82	85390	1
		100	-	-	-	4203 85	85390	1
		160	-	-	-	4203 87	92340	1
		250	-	-	-	4203 89	107550	1
70 kA	DPX ³ 250	40	-	-	-	4206 55	107830	1
		100	-	-	-	4206 57	107830	1
		160	-	-	-	4206 58	121850	1
		250	-	-	-	4206 59	166920	1

■ Price available on request.

* MRP - Maximum Retail Price Inclusive of all taxes including GST.

Bold Cat.Nos are products normally available with Legrand (India) Stockists. Cat.Nos that are not bold - delivery within 4 - 8 weeks from the date of order. Bold packing quantity is our mandatory packing. Orders to be placed by Legrand (India) Stockist in multiples of the same.

DPX³ MCCB

DPX³ MCCB with electronic Sg (LSIg) protection unit

- Range: 40A – 1600A, Ics=100%Icu, Three Optimum Frames
- Protection against Overloads:
 - Ir adjustable from 0.4 to 1 x In
 - tr adjustable from 3 to 30s#
- Protection against Short Circuits:
 - Isd adjustable from 1.5 to 10 x Ir
 - tsd adjustable from 0 to 0.5s
- Inbuilt Instantaneous Protection:
 - li# – Fixed
- Protection against Ground Fault:
 - Ig adjustable from 0.2 to 1 In & OFF
 - tg adjustable from 0.1 to 1s
- Breaking Capacity#– 25kA, 36kA, 50kA, 70kA & 100kA
- In built Display for Current Metering with high accuracy of class 1
- Internal Battery with battery measure function
- Communication Ready via COMM Port
- Logical Selectivity Ready (Zone Selective Interlocking)
- Dynamic Selectivity as per Selectivity Charts
- In Built USB Port for Software Diagnosis
- Switchable Thermal Memory
- Suitable for Isolation

Category	Type	Rated Current (A)	3P			4P		
			Cat.Nos	MRP*/₹/Unit	Pack	Cat.Nos	MRP*/₹/Unit	Pack

Electronic Sg

25 KA	DPX ³ 250	40	4205 02	44200	1	4205 12	49480	1
		100	4205 05	44200	1	4205 15	49480	1
		160	4205 07	49180	1	4205 17	54530	1
		250	4205 09	54370	1	4205 19	63620	1
36 KA	DPX ³ 250	40	4205 22	46810	1	4205 32	52740	1
		100	4205 25	46810	1	4205 35	52740	1
		160	4205 27	51690	1	4205 37	54820	1
		250	4205 29	53080	1	4205 39	56220	1
	DPX ³ 630	320	4221 37	64690	1	4221 42	70130	1
		400	4221 38	64690	1	4221 43	70130	1
		500	4221 39	67160	1	4221 44	80810	1
		630	4221 40	67160	1	4221 45	80810	1
	DPX ³ 1600	800	4223 96	136100	1	4224 02	164070	1
		1000	4223 97	180850	1	4224 03	237970	1
		1250	4223 98	203220	1	4224 04	272180	1
		1600	4223 99	211300	1	4224 05	319620	1
50 KA	DPX ³ 250	40	4205 42	48210	1	4205 52	53290	1
		100	4205 45	48210	1	4205 55	53290	1
		160	4205 47	53060	1	4205 57	58040	1
		250	4205 49	54440	1	4205 59	68000	1
	DPX ³ 630	320	4221 47	65480	1	4221 52	76170	1
		400	4221 48	65480	1	4221 53	76170	1
		500	4221 49	71870	1	4221 54	90630	1
		630	4221 50	71870	1	4221 55	90630	1
	DPX ³ 1600	800	4224 08	145730	1	4224 14	165870	1
		1000	4224 09	195700	1	4224 15	248060	1
		1250	4224 10	216230	1	4224 16	276720	1
		1600	4224 11	230700	1	4224 17	328410	1

* MRP - Maximum Retail Price Inclusive of all taxes including GST.
 ■ Price available on request.

Bold Cat.Nos are products normally available with Legrand (India) Stockists. Cat.Nos that are not bold - delivery within 4 - 8 weeks from the date of order. Bold packing quantity is our mandatory packing. Orders to be placed by Legrand (India) Stockist in multiples of the same.

DPX³ MCCB

DPX³ MCCB with electronic Sg (LSI)g protection unit

Category	Type	Rated Current (A)	3P			4P		
			Cat.Nos	MRP*/₹/Unit	Pack	Cat.Nos	MRP*/₹/Unit	Pack
Electronic Sg								
70 kA	DPX ³ 250	40	4206 92	50670	1	4207 02	57430	1
		100	4206 95	50670	1	4207 05	57430	1
		160	4206 97	59240	1	4207 07	66230	1
		250	4206 99	60670	1	4207 09	69710	1
	DPX ³ 630	320	4221 57	76790	1	4221 62	94750	1
		400	4221 58	76790	1	4221 63	94750	1
		500	4221 59	88420	1	4221 64	120320	1
		630	4221 60	88420	1	4221 65	120320	1
	DPX ³ 1600	800	4224 20	148310	1	4224 26	178860	1
		1000	4224 21	207300	1	4224 27	320710	1
		1250	4224 22	288800	1	4224 28	371270	1
		1600	4224 23	389960	1	4224 29	437670	1

DPX³ MCCB

DPX³ MCCB with electronic S2[#] (LSI)[#] & energy metering protection unit

- Range: 40A – 1600A, Ics=100%Icu, Three Optimum Frames
- Protection against overloads:
 - Ir adjustable from 0.4 to 1 x In
 - tr adjustable from 3 to 30s#
- Protection against short circuits:
 - I_{sd} adjustable from 1.5 to 10 x Ir
 - t_{sd} adjustable from 0 to 0.5s
- Inbuilt Instantaneous Protection:
 - Ii# – Fixed
- Option for In built or add on module for Earth Leakage Protection##
 - Adjustable sensitivity: 0.03 - 0.3 - 1 - 3 A
 - Adjustable tripping: 0 - 0.3 - 1 - 3s
- Breaking Capacity# – 25kA, 36kA, 50kA, 70kA & 100kA
- Integrated energy metering with accuracy class 2
- Measure for currents, voltage, frequency, power, energy and harmonics
- Internal Battery with battery measure function
- Communication Ready via COMM Port
- Logical Selectivity Ready (Zone Selective Interlocking)
- Dynamic Selectivity as per Selectivity Charts
- In Built USB Port for Software Diagnosis
- Suitable for Isolation

Category	Type	Rated Current (A)	3P			4P		
			Cat.Nos	MRP*/₹/Unit	Pack	Cat.Nos	MRP*/₹/Unit	Pack

Electronic S2 + energy metering

25 KA	DPX ³ 250	40	4204 02	47700	1	4204 12	54600	1
		100	4204 05	47700	1	4204 15	54620	1
		160	4204 07	51720	1	4204 17	59200	1
		250	4204 09	56000	1	4204 19	63850	1
36 KA	DPX ³ 250	40	4204 32	51010	1	4204 42	55410	1
		100	4204 35	51010	1	4204 45	55410	1
		160	4204 37	55620	1	4204 47	62180	1
		250	4204 39	60100	1	4204 49	69960	1
	DPX ³ 630	320	4220 97	67190	1	4221 02	79670	1
		400	4220 98	67190	1	4221 03	79670	1
		500	4220 99	72900	1	4221 04	89610	1
		630	4221 00	72900	1	4221 05	89610	1

■ Price available on request.

* MRP - Maximum Retail Price Inclusive of all taxes including GST.

Bold Cat.Nos are products normally available with Legrand (India) Stockists. Cat.Nos that are not bold - delivery within 4 - 8 weeks from the date of order. Bold packing quantity is our mandatory packing. Orders to be placed by Legrand (India) Stockist in multiples of the same.

DPX³ MCCB
DPX³ MCCB with electronic S2# (LSI)* & energy metering protection unit

Category	Type	Rated Current (A)	3P			4P		
			Cat.Nos	MRP*/₹/Unit	Pack	Cat.Nos	MRP*/₹/Unit	Pack

Electronic S2 + energy metering

36 KA	DPX ³ 1600	800	4223 48	116120	1	4223 54	130340	1
		1000	4223 49	163000	1	4223 55	228510	1
		1250	4223 50	191270	1	4223 56	258980	1
		1600	4223 51	209720	1	4223 57	286060	1
50 KA	DPX ³ 250	40	4204 62	57460	1	4204 72	62210	1
		100	4204 65	57460	1	4204 75	62210	1
		160	4204 67	63120	1	4204 77	68390	1
		250	4204 69	66730	1	4204 79	77060	1
	DPX ³ 630	320	4221 07	71260	1	4221 12	84800	1
		400	4221 08	71260	1	4221 13	84800	1
		500	4221 09	86510	1	4221 14	96680	1
		630	4221 10	86510	1	4221 15	96680	1
DPX ³ 1600	800	4223 60	122540	1	4223 66	151150	1	
	1000	4223 61	154040	1	4223 67	218360	1	
	1250	4223 62	184500	1	4223 68	272970	1	
	1600	4223 63	228510	1	4223 69	313990	1	
70 KA	DPX ³ 250	40	4206 65	60350	1	4206 75	66790	1
		100	4206 67	60350	1	4206 77	66790	1
		160	4206 68	72130	1	4206 78	76620	1
		250	4206 69	72260	1	4206 79	105090	1
	DPX ³ 630	320	4221 17	85570	1	4221 22	99520	1
		400	4221 18	85570	1	4221 23	99520	1
		500	4221 19	90900	1	4221 24	108040	1
		630	4221 20	90900	1	4221 25	109590	1
DPX ³ 1600	800	4223 72	140490	1	4223 78	172630	1	
	1000	4223 73	189410	1	4223 79	259800	1	
	1250	4223 74	225130	1	4223 80	300020	1	
	1600	4223 75	296220	1	4223 81	370410	1	

Electronic S2 + energy metering + electronic earth leakage module

25 KA	DPX ³ 250	40	-	-	-	4204 22	102760	1
		100	-	-	-	4204 25	103260	1
		160	-	-	-	4204 27	109790	1
		250	-	-	-	4204 29	123660	1
36 KA	DPX ³ 250	40	-	-	-	4204 52	104080	1
		100	-	-	-	4204 55	104220	1
		160	-	-	-	4204 57	110680	1
		250	-	-	-	4204 59	124090	1
50 KA	DPX ³ 250	40	-	-	-	4204 82	108160	1
		100	-	-	-	4204 85	109070	1
		160	-	-	-	4204 87	116080	1
		250	-	-	-	4204 89	130550	1
70 KA	DPX ³ 250	40	-	-	-	4206 85	108950	1
		100	-	-	-	4206 87	109940	1
		160	-	-	-	4206 88	116440	1
		250	-	-	-	4206 89	138610	1

* MRP - Maximum Retail Price Inclusive of all taxes including GST.
 ■ Price available on request.

Bold Cat.Nos are products normally available with Legrand (India) Stockists. Cat.Nos that are not bold - delivery within 4 - 8 weeks from the date of order. Bold packing quantity is our mandatory packing. Orders to be placed by Legrand (India) Stockist in multiples of the same.

DPX³ MCCB

DPX³ MCCB with electronic Sg (LSIg) & energy metering protection unit

- Range: 250A – 1600A, Ics=100%Icu, Two Optimum Frames
- Protection against Overloads:
 - Ir adjustable from 0.4 to 1 x In
 - tr adjustable from 3 to 30s
- Protection against Short Circuits:
 - Isd adjustable from 1.5 to 10 x Ir
 - tsd adjustable from 0 to 0.5s
- Inbuilt Instantaneous Protection:
 - li – Fixed
- Protection against Ground Fault:
 - Ig adjustable from 0.2 to 1 In & OFF
 - tg adjustable from 0.1 to 1s
- Breaking Capacity – 36kA, 50kA, 70kA & 100kA
- Integrated energy metering with accuracy class 2
- Measure for currents, voltage, frequency, power, energy and harmonics
- Internal Battery with battery measure function
- Communication Ready via COMM Port
- Logical Selectivity Ready (Zone Selective Interlocking)
- Dynamic Selectivity as per Selectivity Charts
- In Built USB Port for Software Diagnosis
- Switchable Thermal Memory
- Suitable for Isolation

Category	Type	Rated Current (A)	3P			4P		
			Cat.Nos	MRP*/₹/Unit	Pack	Cat.Nos	MRP*/₹/Unit	Pack

Electronic Sg + energy metering

36 KA	DPX ³ 630	320	4221 77	81110	1	4221 82	92240	1		
		400	4221 78	81110	1	4221 83	92240	1		
		500	4221 79	86080	1	4221 84	104470	1		
		630	4221 80	86080	1	4221 85	104470	1		
	DPX ³ 1600	800	4224 44	156810	1	4224 50	182690	1		
		1000	4224 45	200290	1	4224 51	263150	1		
		1250	4224 46	217220	1	4224 52	293310	1		
		1600	4224 47	230120	1	4224 53	340240	1		
		50 KA	DPX ³ 630	320	4221 87	85190	1	4221 92	98350	1
				400	4221 88	85190	1	4221 93	98350	1
500	4221 89			93760	1	4221 94	114450	1		
630	4221 90			93760	1	4221 95	114450	1		
DPX ³ 1600	800		4224 56	141690	1	4224 62	170960	1		
	1000		4224 57	169220	1	4224 63	254770	1		
	1250		4224 58	241360	1	4224 64	311750	1		
	1600		4224 59	■	1	4224 65	362870	1		
	70 KA		DPX ³ 630	320	4221 97	96510	1	4222 02	113840	1
				400	4221 98	96510	1	4222 03	113840	1
500		4221 99		107790	1	4222 04	138650	1		
630		4222 00		107790	1	4222 05	138650	1		
DPX ³ 1600		800	4224 68	150500	1	4224 74	195270	1		
		1000	4224 69	238000	1	4224 75	315810	1		
		1250	4224 70	273700	1	4224 76	362420	1		
		1600	4224 71	362540	1	4224 77	423640	1		

Switch disconnecter

NEW!	DPX ³ 160	160	4201 98	10160	1	4201 99	12760	1
	DPX ³ 250	250	4202 99	19830	1	4203 00	27270	1
	DPX ³ 630	400	4222 16	28460	1	4222 18	39320	1
		630	4222 17	35570	1	4222 19	45630	1
			4224 90	47000	1	4224 94	70410	1
	DPX ³ 1600	800	4224 91	68550	1	4224 95	87050	1
		1250	4224 92	119340	1	4224 96	156400	1
		1600	4224 93	142180	1	4224 97	199730	1

■ Price available on request.

* MRP - Maximum Retail Price Inclusive of all taxes including GST.

Bold Cat.Nos are products normally available with Legrand (India) Stockists. Cat.Nos that are not bold - delivery within 4 - 8 weeks from the date of order. Bold packing quantity is our mandatory packing. Orders to be placed by Legrand (India) Stockist in multiples of the same.

DPX³ MCCB

Category	Type	Rated Current (A)	3P			4P		
			Cat.Nos	MRP*/₹/Unit	Pack	Cat.Nos	MRP*/₹/Unit	Pack

Only magnetic

16 KA	DPX ³ 160	16	4207 10	14710	1	-	-	-
		25	4207 11	14710	1	-	-	-
		50	4207 12	14710	1	-	-	-
		63	4207 13	14710	1	-	-	-
25 KA	DPX ³ 160	16	4207 14	16730	1	-	-	-
		25	4207 15	16730	1	-	-	-
		50	4207 16	16730	1	-	-	-
		63	4207 17	16730	1	-	-	-
36 KA	DPX ³ 250	100	4207 18	29080	1	-	-	-
		160	4207 19	29080	1	-	-	-
		200	4207 20	30750	1	-	-	-
		250	4207 21	32410	1	-	-	-
70 KA	DPX ³ 250	100	4207 22	28420	1	-	-	-
		160	4207 23	28420	1	-	-	-
		200	4207 24	30200	1	-	-	-
		250	4207 25	31970	1	-	-	-

Accessories

Type	Rotary handle				Shunt release											
	Direct		Vary depth		12 V		24 V		48 V		110 V		230 V		400 V	
	Cat.No	MRP	Cat.No	MRP	Cat.No	MRP	Cat.No	MRP	Cat.No	MRP	Cat.No	MRP	Cat.No	MRP	Cat.No	MRP
DPX ³ 160 DPX ³ 250	4201 60	1450	4201 61	2090	4210 12	2820	4210 13	2820	4210 14	2820	4210 15	2820	4210 16	2820	4210 17	2820
DPX ³ 630	4201 62	2320	4201 63	3980												
DPX ³ 1600	0262 61	4830	0262 83	7410	-		4222 39	2980	4222 40	2980	4222 41	2980	4222 42	2980	4222 43	2980

Type	U/V release													
	12 V		24 V		48 V		110 V		230 V		400 V		480 V	
	Cat.No	MRP	Cat.No	MRP	Cat.No	MRP	Cat.No	MRP	Cat.No	MRP	Cat.No	MRP	Cat.No	MRP
DPX ³ 160 DPX ³ 250	4210 18	3530	4210 19	3530	4210 20	3530	4210 21	3490	4210 22	3490	4210 24	3490	4210 25	3490
DPX ³ 630 DPX ³ 1600	-		4222 45	4220	4222 46	4220	4222 47	4190	4222 48	4190	4222 49	4190	-	

Type	Rated Current (A)	Spreaders**				Motor Operator									
		3P (Set of 3)		4P (Set of 4)		24-230V Side		24V		48V		110V		230V	
		Cat.No	MRP	Cat.No	MRP	Cat.No	MRP	Cat.No	MRP	Cat.No	MRP	Cat.No	MRP	Cat.No	MRP
DPX ³ 160		6250 02	850	6250 06	1140										
DPX ³ 250		6250 14	850	6250 18	1140	4210 60	39810	4210 61	35760	4210 61	35760	4210 61	35760	4210 61	35760
DPX ³ 630	Upto 400 A	4226 31	1710	4226 32	2280										
	630 A	6250 04	2030	6250 08	2610	-		0261 40	■	0261 41	■	-		0261 44	57950
DPX ³ 1600	Upto 1250 A	4226 24	11460	4226 25	13920	-		0261 24	■	0261 25	■	0261 26	67100	0261 23	67100
	1600 A	0262 73	29860	0262 74	33530	-		0261 19	■	0261 28	■	0261 29	■	0261 27	67740

* MRP - Maximum Retail Price Inclusive of all taxes including GST.
 ■ Price available on request.

Bold Cat.Nos are products normally available with Legrand (India) Stockists.
 Cat.Nos that are not bold - delivery within 4 - 8 weeks from the date of order.
 Bold packing quantity is our mandatory packing. Orders to be placed by Legrand (India) Stockist in multiples of the same.

DPX³ 160

equipment and mounting accessories



4210 40

Cat.Nos	Description	MRP* ₹ / Unit	Pack
---------	-------------	------------------	------

Equipment for plug-in version

4210 40	For DPX ³ 160 - 3P	23880	1
4210 41	For DPX ³ 160 - 4P	32010	1
4210 44	Set of connectors for auxiliary contacts	3420	1
4210 45	Key barrel and flat key for Padlocks	21800	1
4210 46	Key barrel and star key for Padlocks	19740	1
4210 47	Padlock accessory	6060	1

Connection accessories

4210 26	Set of 3 terminals for High capacity cage terminals	9090	1
4210 27	Set of 4 terminals for High capacity cage terminals	12010	1
4210 70	Set of 3 Insulated Shields/ Phase barriers	200	1
4210 28	Set of 3 terminals Screw terminals for copper bars connection	1030	1
4210 29	Set of 4 terminals Screw terminals for copper bars connection	1070	1
6250 02	Set of 3 spreaders for DPX ³ 160 3P	850	1
6250 06	Set of 4 spreaders for DPX ³ 160 4P	1140	1

Connection accessories

4210 36	Set of 3 rear terminals for DPX ³ 160 3P	4860	1
4210 37	Set of 4 rear terminals for DPX ³ 160 4P	6520	1

Sealable terminal shields

For front terminals

4210 54	For DPX ³ 160 3P	5310	1
4210 55	For DPX ³ 160 3P	5600	1

For rear terminals

4210 50	For DPX ³ 160 3P	3350	1
4210 51	For DPX ³ 160 4P	2980	1

Fixing plates

4210 71	For DPX ³ 160 3P / 4P without earth leakage module	490	1
4210 73	For DPX ³ 160 4P with earth leakage module	1200	1
4210 68	For DPX ³ 160 3P / 4P with side mounting motor operator	1230	1

■ Price available on request.

* MRP - Maximum Retail Price Inclusive of all taxes including GST.

MCCB Prices are without spreaders. For ordering spreaders refer page no. 21

DPX³ 160 and 250

common auxiliaries & accessories



4210 58

Cat.Nos	Description	MRP* ₹ / Unit	Pack
---------	-------------	------------------	------

Supply inverter type

4210 58	For fixed version	4480	1
4210 59	For plug-in and draw-out version	4770	1

Rotary handles

4201 60	Standard handle for thermal magnetic DPX ³	1450	1
4201 61	Vari-depth standard handles	2090	1
4201 67	Key Lock for VD RH DPX ³ 160 & 250	2550	1
4201 65	Key Lock for DIR RH Type A DPX ³ 160 & 250	2470	1
4201 68	Key Lock for VD RH Type A DPX ³ 160 & 250	2550	1
4201 66	Key Lock for DIR RH Type B DPX ³ 160 & 250	2470	1
4201 69	Key Lock for VD RH Type B DPX ³ 160 & 250	2550	1

Motor-driven handles

4210 60	Side motor operator	39810	1
4210 61	Front motor operator	35760	1
4210 62	Ronis key barrel for front motor operator	8170	1
4210 63	Profalux key barrel for front motor operator	19410	1

DPX³ 160 and 250 common

Auxiliaries & accessories

4210 64	Padlock for front motor operator	2770	1
4210 65	Ronis key barrel for side motor operator	21550	1
4210 66	Profalux key barrel for side motor operator	19580	1
4210 67	Padlock for side motor operator	2940	1

Auxiliary contacts

4210 10	1 N/C + 1 N/O auxiliary contact for rotary handles	1620	1
4210 11	Auxiliary contact or fault signalling contact	1270	1
4210 48	Signalling contact plugged-in/drawn-out (for DPX ³ plug-in version)	1360	1

Locking accessory

4210 49	Padlock for locking in "open" position	1390	1
---------	--	------	---

Communication interface

4210 75	Modbus	18390	1
---------	--------	-------	---

Bold Cat.Nos are products normally available with Legrand (India) Stockists. Cat.Nos that are not bold - delivery within 4 - 8 weeks from the date of order. Bold packing quantity is our mandatory packing. Orders to be placed by Legrand (India) Stockist in multiples of the same.



4210 36



4210 10



4210 11

DPX³ 250 equipment and mounting accessories

Cat.Nos	Description	MRP* ₹ / Unit	Pack
---------	-------------	------------------	------

Equipment for plug-in version

4210 42	For DPX ³ 250 - 3P	26740	1
4210 43	For DPX ³ 250 - 4P with or without earth leakage module	32220	1
4210 44	Set of connectors for auxiliary contacts	3420	1
4210 45	Key barrel and flat key N° ABA90GEL6149 for Padlocks	21800	1
4210 46	Key barrel and star key N° HBA90GPS6149 for Padlocks	19740	1
4210 47	Padlock accessory	6060	1

Connection accessories

4210 30	Set of 3 cage terminals	3660	1
4210 31	Set of 4 cage terminals	4770	1
4210 70	Set of 3 phase barriers	200	1

Connection accessories

6250 14	Set of 3 spreaders for DPX ³ 250 3P	850	1
6250 18	Set of 4 spreaders for DPX ³ 250 4P	1140	1
4210 38	Set of 3 rear terminals for DPX ³ 250 3P	4910	1
4210 39	Set of 4 rear terminals for DPX ³ 250 4P	6610	1

Sealable terminal shields

For front terminals

4210 56	For DPX ³ 250 3P	5490	1
4210 57	For DPX ³ 250 4P	5820	1

For rear terminals

4210 52	For DPX ³ 250 3P	3280	1
4210 53	For DPX ³ 250 4P	3610	1

Fixing plates

4210 72	For DPX ³ 250 3P / 4P without earth leakage module	490	1
4210 74	For DPX ³ 250 4P with earth leakage module	2080	1
4210 69	For DPX ³ 250 3P / 4P with side mounting motor operator	1220	1

DPX³ 630 equipment and accessories

Plug-in version

4222 20	Set of incoming and outgoing terminals - 3P (6 terminals for 3P DPX ³ or 8 terminals for 4P DPX ³)	4340	1
---------	---	------	---

DPX³ 630 equipment and accessories

Cat.Nos	Description	MRP* ₹ / Unit	Pack
---------	-------------	------------------	------

Plug-in version

4222 21	Set of incoming and outgoing terminals - 4P (6 terminals for 3P DPX ³ or 8 terminals for 4P DPX ³)	5420	1
4222 22	Front terminal mounting base for DPX ³ only - 3P	10830	1
4222 24	Flat rear terminal mounting base for DPX ³ only - 3P	16870	1
4222 23	Front terminal mounting base for DPX ³ only - 4P	13560	1
4222 25	Flat rear terminal mounting base for DPX ³ only - 4P	33480	1
4222 26	Front terminal mounting base for DPX ³ with earth leakage module - 4 P	■	1
4222 27	Flat rear terminal mounting base for DPX ³ with earth leakage module - 4P	■	1
4222 37	For fixing the signalling contact - 4P Cat.No 0265 74 on a DPX ³ plug-in version	3610	1
4222 28	Set of 2 extractor handle	5060	1
4222 29	Set of connectors (24-pin)	2840	1

Draw-out version

4222 31	"Debro-lift" mechanism for DPX ³ base only - 3P	33260	1
4222 32	"Debro-lift" mechanism for DPX ³ base only - 4P	34830	1
4222 33	"Debro-lift" mechanism for DPX ³ base with elm - 4P	■	1
0265 76	One key for "Debro-lift" mechanism for DPX ³ only - Flat key	■	1
0265 78	Two keys (one key supplied) for "Debro-lift" mechanism for motorised DPX ³ or with rotary handle - Flat key	■	1
0263 48	One key for "Debro-lift" mechanism for DPX ³ only - Star key	■	1
0265 77	Two keys (one key supplied) for motorised DPX ³ or with rotary handle - Star key	■	1
0265 75	Handle for drawing-out for "Debro-lift" mechanism	5340	1
0265 74	Signalling contact (plugged-in/drawn-out) for "Debro-lift" mechanism	3390	1
4222 36	For fixing the signalling contact Cat.No 0265 74 on a DPX ³ draw-out version	3640	1

■ Price available on request.

* MRP - Maximum Retail Price Inclusive of all taxes including GST.

MCCB Prices are without spreaders. For ordering spreaders refer page no. 21

Bold Cat.Nos are products normally available with Legrand (India) Stockists. Cat.Nos that are not bold - delivery within 4 - 8 weeks from the date of order. Bold packing quantity is our mandatory packing. Orders to be placed by Legrand (India) Stockist in multiples of the same.

DPX³ 630 equipment and accessories

Cat.Nos	Description	MRP* ₹ / Unit	Pack
---------	-------------	------------------	------

Draw-out version

4222 30	Block of 6 automatic auxiliary contacts for DPX ³ draw-out version (up to 2 blocks by DPX ³)	7040	1
---------	---	------	---

Supply inverter type

0264 09	Plate for MCCB or trip-free switch fixed version	11630	1
0264 04	Plate for MCCB or trip-free switch plug-in and draw-out version	15690	1

Rotary handles

4201 62	Direct rotary handle	2320	1
4201 63	Vari-depth rotary handle	3980	1
4201 70	Key Lock for VD RH DPX ³ 630	2770	1
4201 71	Key Lock for VD RH Type A DPX ³ 630	2770	1
4201 72	Key Lock for VD RH Type B DPX ³ 630	2770	1

Motor-driven handles

0261 40	Front operated 24 V~/=	■	1
0261 41	Front operated 48 V~/=	■	1
0261 44	Front operated 230 V~	57950	1
0261 59	Lock and flat key	9170	1
0261 58	Lock and star key	16570	1

Accessories

0262 30	Set of 3 Insulated Shields/ Phase barriers	240	1
0262 44	Set of 2 sealable terminal shields - 3P	6750	1
0262 45	Set of 2 sealable terminal shields - 4P	2020	1
0262 40	Padlock for locking in "OPEN" position - 4P	2440	1
0262 46	Set of 4 adaptors + Insulated Shields/ Phase barriers for lug - 4P	9470	1
0262 47	Set of 4 extended front terminals-4P	7150	1
6250 04	Set of incoming or outgoing spreaders - 3P	2030	1
6250 08	Set of incoming or outgoing spreaders - 4P	2610	1
0263 50	Set of incoming or outgoing swivel rear terminals - 3P	■	1
0263 52	Set of incoming or outgoing flat rear terminals - 3P	23080	1
0263 51	Set of incoming or outgoing swivel terminals - 4P	■	1
0263 53	Set of incoming or outgoing flat terminals - 4P	19600	1
4222 34	Set of 2 IP 20 terminal covers - 3P	1540	1
4222 35	Set of 2 IP 20 terminal covers - 4P	5350	1



0261 40



6250 04



4222 34



4222 35

■ Price available on request.

* MRP - Maximum Retail Price Inclusive of all taxes including GST.

DPX³ 630 earth leakage module

Type and frame size	Rated Current (A)	Poles	Cat.Nos	MRP* ₹ / Unit	Pack
---------------------	-------------------	-------	---------	------------------	------

Earth leakage module

Standard

DPX ³ 630	400 A	3 Pole	0260 60	42080	1
	630 A	3 Pole	0260 64	78370	1
	400 A	4 Pole	0260 61	73870	1
	630 A	4 Pole	0260 65	77860	1

LED version

DPX ³ 630	400 A	4 Pole	0260 63	■	1
	630 A	4 Pole	0260 67	76290	1

DPX³ 1600 equipment and accessories

Cat.Nos	Description	MRP* ₹ / Unit	Pack
---------	-------------	------------------	------

Draw-out version

4225 86	Front terminals - 3P	■	1
4225 88	Rear terminals - 3P	■	1
4225 87	Front terminals - 4P	■	1
4225 89	Rear terminals - 4P	■	1
4225 93	Debro-lift mechanism For DPX ³ 1600 - 3P	■	1
4225 94	Debro-lift mechanism for DPX ³ 1600 - 4P	■	1
4225 95	For fixing the signalling contact Cat.No 0265 74 on a DPX ³ draw-out version	■	1
0265 76	One key for "Debro-lift" mechanism for DPX ³ only - Flat key	■	1
0265 80	Two key (one key supplied) for motorised DPX ³ or with rotary handle	■	1
0263 48	One key for DPX ³ only - Starkey	■	1
0265 79	Two key (one key supplied) for motorised DPX ³ or with rotary handle	■	1
0265 75	Handle for drawing-out for "Debro-lift" mechanism	5340	1
0265 74	Signalling contact (plugged-in/drawn-out)	3390	1
4222 30	Block of 6 automatic auxiliary contacts for DPX ³ draw-out version (up to 2 blocks by DPX ³)	7040	1



4225 88
+
4225 93

Bold Cat.Nos are products normally available with Legrand (India) Stockists. Cat.Nos that are not bold - delivery within 4 - 8 weeks from the date of order. Bold packing quantity is our mandatory packing. Orders to be placed by Legrand (India) Stockist in multiples of the same.

DPX³ 1600 equipment and accessories

Cat.Nos	Description	MRP* ₹ / Unit	Pack
---------	-------------	------------------	------

Supply inverter type

0264 10	Plate for MCCBs or trip-free switch fixed version	14000	1
0264 05	Plate for MCCBs or trip-free switch plug-in and draw-out version	31030	1

Rotary handles

0262 61	Standard (black) direct on DPX ³	4830	1
0262 83	Standard (black) vari-depth handle IP 55	7410	1
0262 93	Key barrel and flat key	2750	1
0262 94	Key barrel and star key	15190	1

Motor-driven handles

0261 54	Front operated 230 V±	83980	1
0261 24	Front operated 24 V±/= for I _n ≤ 1250 A	140520	1
0261 25	Front operated 48 V±/= for I _n ≤ 1250 A	110200	1

Motor-driven handles

0261 26	Front operated 110 V±/= for I _n ≤ 1250 A	67100	1
0261 23	Front operated 230 V±/= for I _n ≤ 1250 A	67100	1
0261 19	Front operated 24 V±/= for I _n = 1600 A	140520	1
0261 28	Front operated 48 V±/= for I _n = 1600 A	110200	1
0261 29	Front operated 110 V±/= for I _n = 1600 A	■	1
0261 27	Front operated 230 V±/= for I _n = 1600 A	67740	1
0261 59	Key and flat key	9170	1
0261 58	Key and star key	16570	1

Accessories

0262 66	Set of 3 Insulated Shields/ Phase barriers	470	1
0262 64	Set of 2 sealable terminal shields - 3P	14180	1
0262 65	Set of 2 sealable terminal shields - 4P	2710	1
0262 60	Padlock for locking in "open" position	2330	1
0262 67	Set of 4 extended front short terminals for 630 - 1250 A (2 bars max. per pole)	17220	1



0262 60

- Price available on request.
- * MRP - Maximum Retail Price Inclusive of all taxes including GST.
- ❖ For Cat.Nos. and further details please contact th nearest branch.
- ▼ For communication add 4226 82 + 4226 89

DPX³ 630 and 1600 common auxiliaries

Cat.Nos	Description	MRP* ₹ / Unit	Pack
---------	-------------	------------------	------

Accessories

0262 68	Set of 4 extended front Long terminals for 1600 A (3 bars max. per pole)	23100	1
4226 24	Set of incoming or outgoing spreaders for 800 A & 1000 A - 3P	11460	1
4226 25	Set of incoming or outgoing spreaders for 800 A & 1000 A - 4P	13920	1
0262 73	Set of incoming or outgoing spreaders for 1250 A & 1600 A - 3P	29860	1
0262 74	Set of incoming or outgoing spreaders for 1250 A & 1600 A - 4P	33530	1
0263 80	Short rear terminals - 3P	■	1
0263 81	Long rear terminals - 3P	■	1
0263 82	Short rear terminals - 4P	■	1
0263 83	Long rear terminals - 4P	■	1
4225 90	Set of 2 IP 20 terminal covers - 3P	1710	1
4225 91	Set of 2 IP 20 terminal covers - 4P	2780	1
4225 92	External neutral - 4P	18150	1



0262 67
+
0262 68

Common auxiliaries

4210 11	For signalling the state of the contacts or opening of the MCCB on a fault For DPX ³ /DPX ³ -I Changeover switch 3 A - 240 V±	1270	1
---------	--	------	---

Releases

Allow remote tripping of a DPX³

Time-lag undervoltage releases (800 ms)

Prevent false tripping in the event of power supply microbreaks.

Require a time-lag module connected to the undervoltage release Cat.No 4226 23

0261 90	Time-lag module 230 VA 3 module	25540	1
---------	------------------------------------	-------	---

Bold Cat.Nos are products normally available with Legrand (India) Stockists. Cat.Nos that are not bold - delivery within 4 - 8 weeks from the date of order. Bold packing quantity is our mandatory packing. Orders to be placed by Legrand (India) Stockist in multiples of the same.

DPX³ MCCB

Rotary handles
for DPX³



- Smaller dimension of rotary handle base for better visibility of parameters and better access to trip unit
- Easy installation
- Spring for better play
- Door defeat mechanism for easy maintenance
- ON / OFF indication on the knob
- Pad Locking on the knob – upto 3 Locks



Scan to know more about
the product.

Cat.Nos	Description	MRP* ₹ / Unit	Pack
---------	-------------	---------------------	------

Releases

0261 91	Time-lag module 400 VA	37280	1
4226 23	Undervoltage release for DPX ³ 630 and 1600	■	1

Auto transfer controller

4226 81	Standard unit	38150	1
4226 82	Advanced unit	44510	1
4226 89▼	Communication module	11930	1

Residual current relay

0260 88	Residual current relay to clip on module 2 rail	26500	1
---------	--	-------	---

Current transformer

0260 92	Coil Ø35 mm	14470	1
0260 93	Coil Ø80 mm	21110	1
0260 94	Coil Ø110 mm	32550	1
0260 95	Coil Ø140 mm	34250	1
0260 96	Coil Ø210 mm	58420	1
0260 97	Coil Ø150 mm - open	■	1
0260 98	Coil Ø300 mm - open	■	1

Metal one way enclosures for MCCB

Cat.Nos	Description	No. of modules	MRP* ₹ / Unit	Pack
5078 01	DPX3 160 MCCB enclosure	3&4	5370	1
5078 02	DPX3 250 MCCB enclosure	3&4	9450	1
5078 04	DPX3 630 MCCB enclosure	3&4	14460	1

■ Price available on request.

* MRP - Maximum Retail Price Inclusive of all taxes including GST.

◆ For Cat.Nos. and further details please contact the nearest branch.

▼ For communication add 4226 82 + 4226 89



4226 82



0260 88



0260 93
coil for use
with relay



0260 98

Bold Cat.Nos are products normally available with Legrand (India) Stockists. Cat.Nos that are not bold - delivery within 4 - 8 weeks from the date of order. Bold packing quantity is our mandatory packing. Orders to be placed by Legrand (India) Stockist in multiples of the same.

DRX

MCCB RANGE

MCCB RANGE



DRX MCCB WORLD CLASS SOLUTION WITH A RANGE OF ACCESSORIES AND WINNING FEATURES

NEW DRX MCCBs RANGE.
MULTIPLE FEATURES.



Accurate performance at higher temperature "No Deration upto 50° Cel"



Overload & Overload Pre-Alarm Indication



Integrated Contact module for Status Indication



Complete Range with Adjustable Protection



In built Neutral Protection in 4th Pole



Switchable Thermal Memory



Over - Temperature Alarm Indication



Adjustable Time Settings

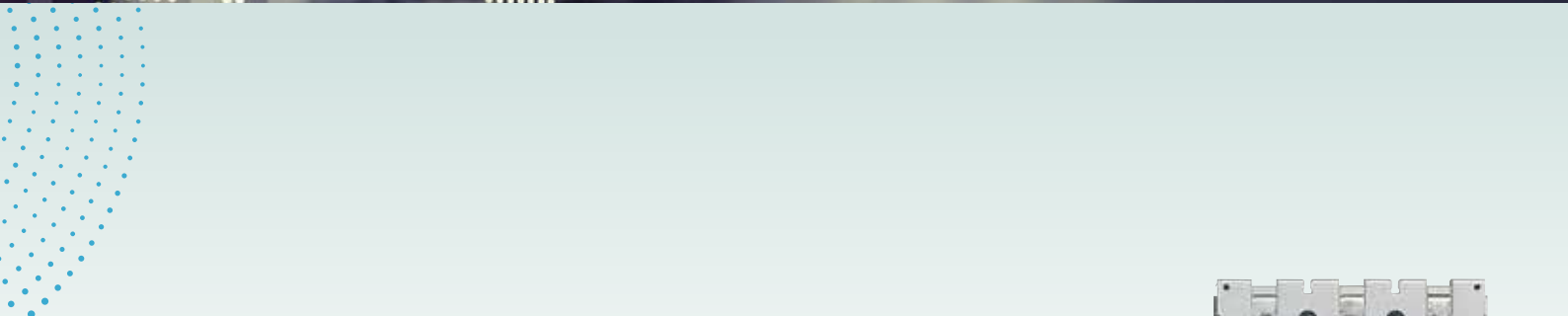

A COMPREHENSIVE RANGE

The robust design of DRX MCCB offer adjustable protection, different accessories for connection and remote tripping. They are the ideal choice in terms of efficiency and affordability for protection of your electrical installations of up to 630A.



Scan to know more about the product.

DRX MCCB

DRX MCCB with thermal magnetic protection unit

Range – 16A to 630A

Ics = 100% Icu

Thermal Adjustable – 0.8 to 1 In

Magnetic Setting – 10 In for DRX125HP

Magnetic Setting – Adjustable 5 to 10 In for DRX250HP and DRX630

Suitable for Isolation

Category	Type	Rated Current (A)	3P			4P		
			Cat.Nos	MRP*/₹/Unit	Pack	Cat.Nos	MRP*/₹/Unit	Pack

Thermal magnetic : O/L & S/C protection

25 KA	DRX 125 ^{HP}	16	6697 00	8380	1	6697 10	11650	1
		20	6697 01	8380	1	6697 11	11650	1
		25	6697 02	8380	1	6697 12	11650	1
		32	6697 03	8380	1	6697 13	11650	1
		40	6697 04	8380	1	6697 14	11650	1
		50	6697 05	8380	1	6697 15	11650	1
		63	6697 06	8380	1	6697 16	11650	1
		80	6697 07	8380	1	6697 17	11650	1
		100	6697 08	8380	1	6697 18	11650	1
		125	6697 09	12410	1	6697 19	14720	1
36 KA	DRX 125 ^{HP}	16	6697 20	10910	1	6697 30	13610	1
		20	6697 21	10910	1	6697 31	13610	1
		25	6697 22	10910	1	6697 32	13610	1
		32	6697 23	10910	1	6697 33	13610	1
		40	6697 24	10910	1	6697 34	13610	1
		50	6697 25	10910	1	6697 35	13610	1
		63	6697 26	10910	1	6697 36	13610	1
		80	6697 27	10910	1	6697 37	13610	1
		100	6697 28	10910	1	6697 38	13610	1
		125	6697 29	12550	1	6697 39	15840	1
50 KA	DRX 125 ^{HP}	16	6697 40	13940	1	6697 50	17570	1
		20	6697 41	13940	1	6697 51	17570	1
		25	6697 42	13940	1	6697 52	17570	1
		32	6697 43	13940	1	6697 53	17570	1
		40	6697 44	13940	1	6697 54	17570	1
		50	6697 45	13940	1	6697 55	17570	1
		63	6697 46	13940	1	6697 56	17570	1
		80	6697 47	13940	1	6697 57	17570	1
		100	6697 48	13940	1	6697 58	17570	1
		125	6697 49	18270	1	6697 59	21050	1

■ Price available on request.

* MRP - Maximum Retail Price Inclusive of all taxes including GST.

Bold Cat.Nos are products normally available with Legrand (India) Stockists. Cat.Nos that are not bold - delivery within 4 - 8 weeks from the date of order. Bold packing quantity is our mandatory packing. Orders to be placed by Legrand (India) Stockist in multiples of the same.

DRX MCCB

DRX MCCB with thermal magnetic protection unit

Category	Type	Rated Current (A)	3P			4P			
			Cat.Nos	MRP*/₹/Unit	Pack	Cat.Nos	MRP*/₹/Unit	Pack	
Thermal magnetic : O/L & S/C protection									
25 KA	DRX 250 ^{HP}	16	6690 00	■	1	6690 20	■	1	
		20	6690 01	■	1	6690 21	■	1	
		25	6690 02	■	1	6690 22	■	1	
		32	6690 03	■	1	6690 23	■	1	
		40	6690 04	12660	1	6690 24	15430	1	
		50	6690 05	12660	1	6690 25	15430	1	
		63	6690 06	12660	1	6690 26	15430	1	
		80	6690 07	12660	1	6690 27	15430	1	
		100	6690 08	13320	1	6690 28	16190	1	
		125	6690 09	14070	1	6690 29	17400	1	
		160	6690 10	17760	1	6690 30	20600	1	
		200	6690 11	20220	1	6690 31	24780	1	
		250	6690 12	23510	1	6690 32	28130	1	
36 KA	DRX 250 ^{HP}	16	6690 40	■	1	6690 60	■	1	
		20	6690 41	■	1	6690 61	■	1	
		25	6690 42	■	1	6690 62	■	1	
		32	6690 43	■	1	6690 63	■	1	
		40	6690 44	13040	1	6690 64	16070	1	
		50	6690 45	13040	1	6690 65	16070	1	
		63	6690 46	13040	1	6690 66	16070	1	
		80	6690 47	13040	1	6690 67	16070	1	
		100	6690 48	13690	1	6690 68	16850	1	
		125	6690 49	15370	1	6690 69	18040	1	
		160	6690 50	17940	1	6690 70	20870	1	
		200	6690 51	22210	1	6690 71	28690	1	
		250	6690 52	25430	1	6690 72	30640	1	
		DRX 630	320	6676 50	31190	1	6676 54	37980	1
			400	6676 51	31190	1	6676 55	38690	1
			500	6676 52	40210	1	6676 56	50600	1
			630	6676 53	40210	1	6676 57	53010	1



6676 51

■ Price available on request.

* MRP - Maximum Retail Price Inclusive of all taxes including GST.

Bold Cat.Nos are products normally available with Legrand (India) Stockists. Cat.Nos that are not bold - delivery within 4 - 8 weeks from the date of order. Bold packing quantity is our mandatory packing. Orders to be placed by Legrand (India) Stockist in multiples of the same.

DRX MCCB

DRX MCCB with thermal magnetic protection unit

Category	Type	Rated Current (A)	3P			4P		
			Cat.Nos	MRP*/₹/Unit	Pack	Cat.Nos	MRP*/₹/Unit	Pack

Thermal magnetic : O/L & S/C protection

50 KA	DRX 250 ^{HP}	16	6690 80	■	1	6691 00	■	1
		20	6690 81	■	1	6691 01	■	1
		25	6690 82	■	1	6691 02	■	1
		32	6690 83	■	1	6691 03	■	1
		40	6690 84	18400	1	6691 04	22120	1
		50	6690 85	18400	1	6691 05	22140	1
		63	6690 86	18400	1	6691 06	22140	1
		80	6690 87	18400	1	6691 07	22140	1
		100	6690 88	19320	1	6691 08	23250	1
		125	6690 89	20050	1	6691 09	24130	1
		160	6690 90	22390	1	6691 10	26080	1
		200	6690 91	27080	1	6691 11	33700	1
		250	6690 92	29120	1	6691 12	35860	1
		DRX 630	320	6676 58	34340	1	6676 62	43190
400	6676 59		34340	1	6676 63	43190	1	
500	6676 60		48640	1	6676 64	60770	1	
630	6676 61		48640	1	6676 65	60770	1	



6690 92



6676 61

DRX MCCB

DRX MCCB with electronic S2 (LSI) protection unit

- Range: 40A – 630A, Ics=100%Icu, Two Optimum Frames
- Protection against overloads:
 - Ir adjustable from 0.4 to 1 x In
 - tr adjustable from 3 to 30s#
- Protection against short circuits:
 - Isd adjustable from 1.5 to 10 x Ir
 - tsd adjustable from 0 to 0.5s
- Inbuilt Instantaneous Protection:
 - li# – Fixed
- Overload Alarm Indication - I > 1.05 Ir
- Pre-Overload Alarm Indication - I > 0.9 Ir
- Over temperature Alarm Indication - T > 90 °C
- Integrated Contact Module (On/Off/ Trip) for DRX 250HP Electronic MCCBs
- Suitable for Isolation

Category	Type	Rated Current (A)	3P			4P		
			Cat.Nos	MRP*/₹/Unit	Pack	Cat.Nos	MRP*/₹/Unit	Pack

Electronic S2

36 KA	DRX 250 ^{HP}	40	6691 70	19230	1	6691 80	24440	1
		100	6691 71	19230	1	6691 81	24440	1
		160	6691 72	24610	1	6691 82	34420	1
		250	6691 73	33770	1	6691 83	46090	1
	DRX 630	320	6699 01	43390	1	6699 06	53440	1
		400	6699 02	43390	1	6699 07	53440	1
		630	6699 04	48730	1	6699 09	63820	1

* MRP - Maximum Retail Price Inclusive of all taxes including GST.
 ■ Price available on request.

Bold Cat.Nos are products normally available with Legrand (India) Stockists. Cat.Nos that are not bold - delivery within 4 - 8 weeks from the date of order. Bold packing quantity is our mandatory packing. Orders to be placed by Legrand (India) Stockist in multiples of the same.

DRX MCCB

DRX MCCB with electronic S2 (LSI) protection unit

Electronic S2

50 KA	DRX 250 ^{HP}	40	6691 90	23170	1	6692 00	32000	1
		100	6691 91	23170	1	6692 01	32000	1
		160	6691 92	30100	1	6692 02	39460	1
		250	6691 93	38420	1	6692 03	49220	1
	DRX 630	320	6699 11	47470	1	6699 16	60520	1
		400	6699 12	47470	1	6699 17	60520	1
630		6699 14	52660	1	6699 19	67430	1	

DRX MCCB

DRX MCCB with electronic Sg (LSIg) protection unit

- Range: 40A – 630A, Ics=100%Icu, Two Optimum Frames
- Protection against overloads:
 - Ir adjustable from 0.4 to 1 x In
 - tr adjustable from 3 to 30s#
- Protection against short circuits:
 - I_{sd} adjustable from 1.5 to 10 x Ir
 - t_{sd} adjustable from 0 to 0.5s
- Inbuilt Instantaneous Protection:
 - I_{i#} – Fixed
- Protection against Ground Fault:
 - I_g adjustable from 0.2 to 1 In & OFF
 - t_g adjustable from 0.1 to 1s
- Overload Alarm Indication - I > 1.05 Ir
- Pre-Overload Alarm Indication - I > 0.9 Ir
- Over temperature Alarm Indication - T > 90 °C
- Integrated Contact Module (On/Off/ Trip) for DRX 250HP Electronic MCCBs
- Suitable for Isolation

Category	Type	Rated Current (A)	3P			4P		
			Cat.Nos	MRP*/₹/Unit	Pack	Cat.Nos	MRP*/₹/Unit	Pack

Electronic Sg

36 KA	DRX 250 ^{HP}	40	6691 75	34780	1	6691 85	40430	1
		100	6691 76	34780	1	6691 86	40430	1
		160	6691 77	39620	1	6691 87	48520	1
		250	6691 78	46910	1	6691 88	58220	1
	DRX 630	320	6699 21	58920	1	6699 26	67790	1
		400	6699 22	58920	1	6699 27	67790	1
630		6699 24	63760	1	6699 29	78860	1	
50 KA	DRX 250 ^{HP}	40	6691 95	38010	1	6692 05	45070	1
		100	6691 96	38010	1	6692 06	45070	1
		160	6691 97	45290	1	6692 07	53770	1
		250	6691 98	50950	1	6692 08	60100	1
	DRX 630	320	6699 31	60970	1	6699 36	73580	1
		400	6699 32	60970	1	6699 37	73580	1
630		6699 34	65810	1	6699 39	82080	1	



6691 98

- Price available on request.
- * MRP - Maximum Retail Price Inclusive of all taxes including GST.

Bold Cat.Nos are products normally available with Legrand (India) Stockists. Cat.Nos that are not bold - delivery within 4 - 8 weeks from the date of order. Bold packing quantity is our mandatory packing. Orders to be placed by Legrand (India) Stockist in multiples of the same.

Accessories

Type	Rotary handle					
	Direct			Vary depth		
	Cat.No	MRP	Pack	Cat.No	MRP	Pack
DRX 125HP	6687 70	1250	1	6687 71	1910	1
DRX 250HP	6687 72	1270	1	6687 73	1970	1
DRX 630	6687 80	2230	1	6687 81	3680	1



0271 54



4222 42

Type	Shunt release					
	240V AC			415V AC		
	Cat.No	MRP	Pack	Cat.No	MRP	Pack
DRX 125HP	0271 54	■	1	0271 55	■	1
DRX 250HP	4222 42	2980	1	4222 43	2980	1
DRX 630						



0271 65

Type	Undervoltage					
	240V AC			415V AC		
	Cat.No	MRP	Pack	Cat.No	MRP	Pack
DRX 125HP	0271 64	■	1	0271 65	■	1
DRX 250HP	4222 48	4190	1	4222 49	4190	1
DRX 630						

Type	Rated Current (A)	Spreaders					
		3P One Side			4P One Side		
		Cat.No	MRP	Pack	Cat.No	MRP	Pack
DRX 125HP	-	6250 10	270	1	6250 11	390	1
	-	6250 14	850	1	6250 18	1140	1
DRX 250HP	400A	4226 31	1710	1	4226 32	2280	1
DRX 630	630A	6250 04	2030	1	6250 08	2610	1

Type	Rated Current (A)	Phase Barriers					
		3P One Side			4P One Side		
		Cat.No	MRP	Pack	Cat.No	MRP	Pack
DRX 125HP	-	6693 00	170	1	6693 01	220	1
	-						
DRX 250HP	400A	0262 30	240	1	0262 30	240	1
DRX 630	630A						

* MRP - Maximum Retail Price Inclusive of all taxes including GST.
 ■ Price available on request.

Bold Cat.Nos are products normally available with Legrand (India) Stockists.
 Cat.Nos that are not bold - delivery within 4 - 8 weeks from the date of order.
 Bold packing quantity is our mandatory packing. Orders to be placed by Legrand (India) Stockist in multiples of the same.

Accessories



0271 80

Type	Rated Current (A)	Padlocks		
		3P One Side		
		Cat.No	MRP	Pack
DRX 125HP	-	0271 80	170	1
	-			
DRX 250HP	400A	0262 40	2440	1
DRX 630	630A			

Key Locks

Type		Cat.No	MRP	Pack
For DRX 125HP/250HP for Direct Handle	Random	6687 74	2520	1
	A	6687 75	2520	1
	B	6687 76	2520	1

Key Locks

Type		Cat.No	MRP	Pack
For DRX 125HP/250HP for Vary Depth Handle	Random	6687 77	2480	1
	A	6687 78	2480	1
	B	6687 79	2480	1

Key Locks

Type		Cat.No	MRP	Pack
For DRX 630 for Vary Depth Handle	Random	6687 82	2480	1
	A	6687 83	2480	1
	B	6687 84	2480	1



0271 40

Type	Auxilliary Contact			Trip Alarm Contact			Combo (Aux + Trip) Contact		
	Cat.No	MRP	Pack	Cat.No	MRP	Pack	Cat.No	MRP	Pack
DRX 125HP	0271 40	■	1	0271 41	■	1	0271 42	■	1
DRX 250HP									
DRX 630	4210 11	1270	1	4210 11	1270	1	-	-	1

* MRP - Maximum Retail Price Inclusive of all taxes including GST.
 ■ Price available on request.

Bold Cat.Nos are products normally available with Legrand (India) Stockists. Cat.Nos that are not bold - delivery within 4 - 8 weeks from the date of order. Bold packing quantity is our mandatory packing. Orders to be placed by Legrand (India) Stockist in multiples of the same.

LBPLUS DATA



LIGHTING BUSBAR FOR EFFICIENT LIGHTING MANAGEMENT

SIMPLIFIED INSTALLATION FOR INCREASED PERFORMANCE



ENERGY EFFICIENCY

Integrate with dimming systems and lux meters for daytime electricity savings



SIMPLICITY WITH COMFORT

Completely addressable system for user convenience and remote management



MAXIMUM FLEXIBILITY OF USE

The certified protocols that can be used with LBplus data are the DALI and the 1-10 V protocols.



ENVIRONMENT SUSTAINABILITY

With the reduction of energy consumption, there is also an important reduction in the emission of polluting gases in the atmosphere. Renewable energy sources are not the only mean for reaching the environmental sustainability objectives: the starting point is certainly the reduction of existing consumptions



ENERGY SAVING

With LBplus data there is a reduction of both energy consumption due to artificial illumination (upto 75%, according to UNIEN 15193), and energy waste, thanks to the automatic management of lighting



COMPLIANCE WITH THE STANDARDS

With LBplus data, compliance with the EU Directives on energy efficiency both for new and for refurbished buildings is ensured



APPLICATIONS / CAN BE USED AT



SHOPPING CENTRES,
STORES, OFFICES...



WAREHOUSES, GYMS,
UNDERGROUND car parks...



HOSPITALS,
LABORATORIES...



WORKSHOPS, MAINTENANCE & REPAIR
FACILITIES, PRODUCTION SITES...



Scan to know more about
the product.

IP68 RCP

RESIN BUSBAR TRUNKINGS



A SOLUTION THAT ADAPTS TO INDOOR AND OUTDOOR INSTALLATIONS

The **RCP IP68** resin busbar trunking system is a solution mainly for outdoor in extreme conditions such as humidity, corrosion or saline mist environment and temporary immersion risks.

RCP IP68 Resin Busbar

New resin busbar RCP with range from 630 A to 6300 A and IP68 degree of protection represents the complete solution for the **transport** of high-power energy.

This new product is made with internal conductors in aluminium or copper and completely embedded in **a epoxy resin**, which provides mechanical strength and electrical insulation. With RCP is possible to provide specific solutions in different environments (outdoor and indoor) where it isn't possible to reach with busbar IP55.



Scan to know more about the product.

DEGREE OF PROTECTION

IP68

1ST DIGIT IP

Protection against penetration of solid bodies

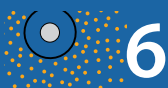

Complete protection against dust

2ND DIGIT IP

Protection against penetration of liquids

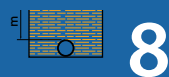

Protection against effects of Immersion under pressure

(At maximum of 1m, as comply by standard EN 61439-6)

BUSBAR TRUNKING

- Resin built-in conductors.
- Insulations of single conductors in polyester film.
- Fully insulated with epoxy resin.
- Rated current between 630 - 6300 A.
- Insulation voltage up to 1000 V.
- Small dimensions.
- Maintenance free.
- Only for Transport of energy.

CONDUCTOR MATERIAL

- Copper: copper busbars with a purity greater than 99.9% .
- Aluminium: aluminium alloy busbars, with entire surface treated with different galvanic processes.
- Degree of protection: IP68 according to the EN 61439-6.

Typical applications

The typical applications of IP68 busbar trunkings are



Industrial plants



Petrochemical plants



Chemical plants (*).



Outdoor (in different extreme conditions).

(* attention at chemical components which are not compatible with the busbar's resin

DSX

SAFETY, STRENGTH
AND EASE OF
INSTALLATION



New range for power
switching needs of
modern installation

ON A DIN RAIL

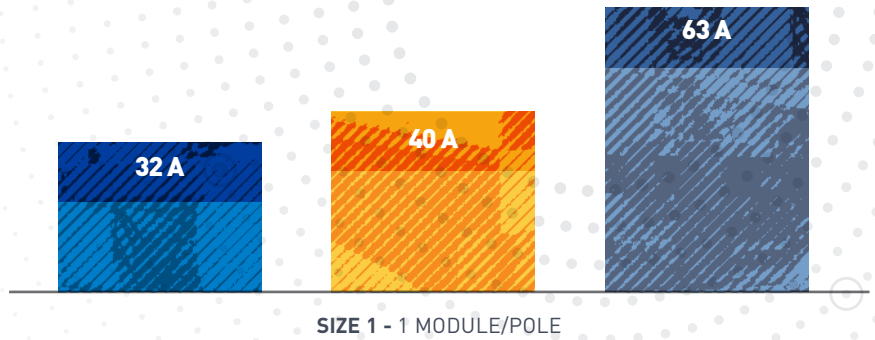

ON A PLATE

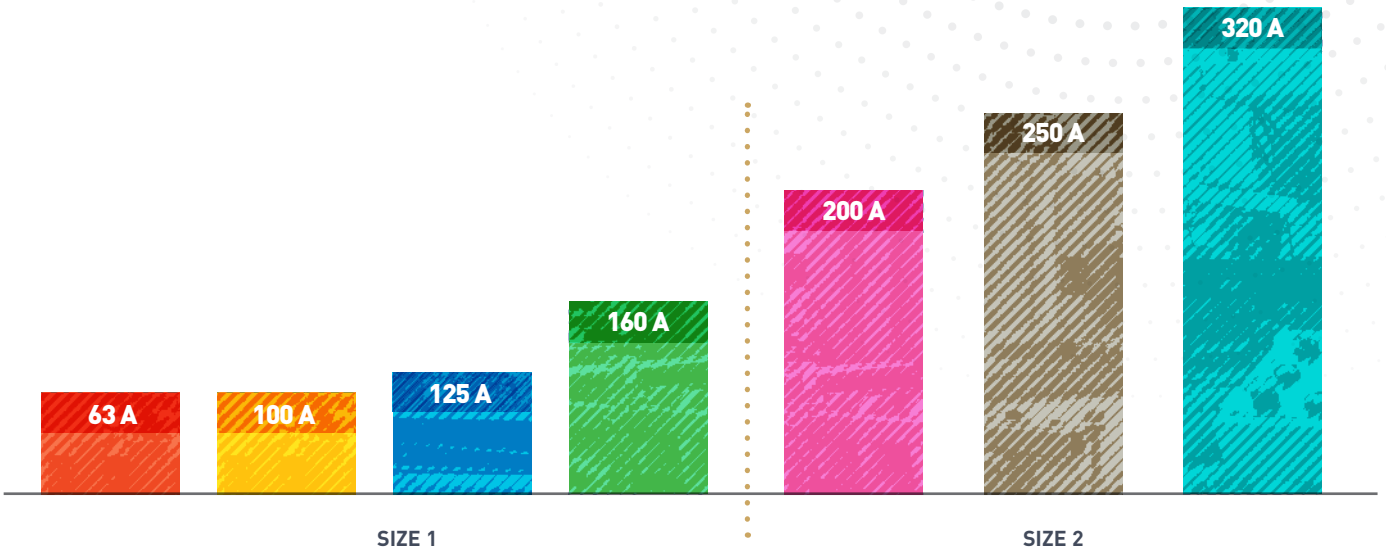

Scan to know more about
the product.



Features:

- Operational Voltage upto 690V AC
- High Electrical and Mechanical Life
- Patented Features - Pop Ind & Visual Contacts
- Best in class accessories

Modular



SD DIN LINE



TSE DIN LINE

Plate Mounted



SD POWER LINE



TSE POWER LINE



DSX

NEW RANGE FOR POWER SWITCHING NEEDS OF MODERN INSTALLATIONS

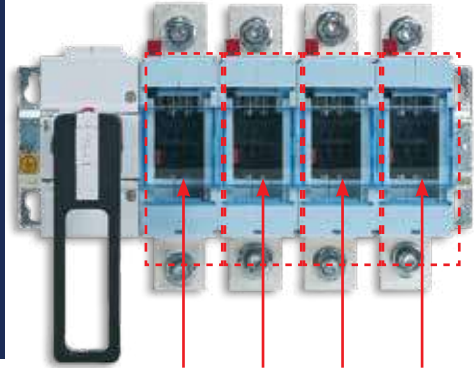

The physical separation of the main contacts is visible through a transparent cover.

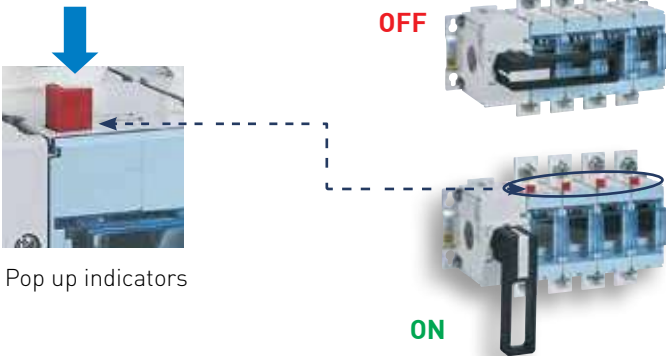

Pop up indicators



Innovative Design



Safe

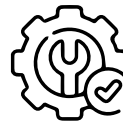

Ease of Installation



Robust

BEST IN CLASS ACCESSORIES FOR SAFETY AND PERFORMANCE

Accessories:



DSX SD/TSE

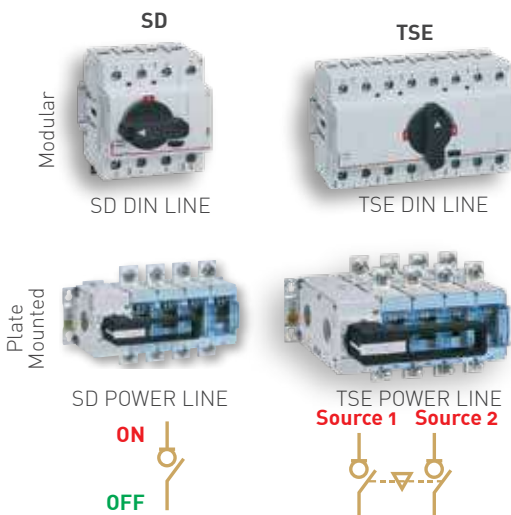

Frame -->	DIN LINE 1	POWER LINE 1	POWER LINE 2
Ratings	32A, 40A, 63A	63A, 100A, 125A, 160A	200A, 250A, 320A
Rated Operational Voltage, U _e	690V AC	690V AC	
Rated Insulation Voltage, U _i	690V AC	1000V AC	
Rated Impulse Voltage, U _{imp}	8kV	8kV	12kV
Mechanical Life	10000	10000	10000
Electrical Life	2000	2500	2000
Icw for 1 Sec	1.5kA	8kA	12.5kA

@12000 for DIN LINE 1 SD/ 10000 for DIN LINE 1 TSE

Type	Rated Current (A)	Switch Disconnecter			TSE (Changeover Switch)			TSE (Changeover Switch) with Enclosure		
		Cat.Nos	MRP*/₹/Unit	Pack	Cat.Nos	MRP*/₹/Unit	Pack	Cat.Nos	MRP*/₹/Unit	Pack
DIN Line Frame 1 (3P + N)	32A	4240 06	3210	1	4241 06	5750	1			
	40A	4240 07	3370	1	4241 07	6000	1			
	63A	4240 08	4010	1	4241 08	7000	1			
POWER Line Frame 1 (4P)	63A	4240 82	4790	1	4241 82	8430	1	4241 92	12570	1
	100A	4240 83	8850	1	4241 83	10590	1	4241 93	15270	1
	125A	4240 84	10860	1	4241 84	14440	1	4241 94	17540	1
POWER Line Frame 2 (4P)	160A	4240 85	14650	1	4241 85	16440	1	4241 95	22600	1
	200A	4240 86	15910	1	4241 86	21980	1	4241 96	26970	1
	250A	4240 87	18600	1	4241 87	30340	1	4241 97	36350	1
	320A	4240 88	20550	1	4241 88	31090	1	4241 98	38090	1

Accessories

	DIN LINE 1		
	Cat.Nos	MRP*/₹/Unit	Pack
Shorting Links for TSE (set of 4)	4242 01	900	1
Terminal Shield IP20 - 3P#	4242 02	370	1
Terminal Shield IP20 - 1P#	4242 03	290	1
Auxiliary contact (1 NO + 1 NC)	4242 08	470	1
Vary Depth Handle	4242 09	1320	1

	POWER LINE 1			POWER LINE 2		
	Cat.Nos	MRP*/₹/Unit	Pack	Cat.Nos	MRP*/₹/Unit	Pack
Auxiliary contact 4 NO + 4NC	4242 45	1320	1	4242 45	1320	1
Aux Contact (1NO+1NC) Early Make/Break	4242 44	1550	1	4242 44	1550	1
Spreaders Terminals (One Side i.e. Set of 4)	4242 54	1030	1	4242 38	2060	1
Terminal Shield IP20 - 4P	4242 47	1050	1	4242 36	1210	1
Phase Barriers	4242 51	210	1	4242 43	260	1
Inter Source Barrier	4242 52	260	1	4242 39	420	1
Shorting Links for TSE (Set of 4)	4242 49	2530	1	4242 41	3790	1
Direct Handle	4242 30	1110	1	4242 30	1110	1
Vary Depth Handle	4242 31	1580	1	4242 31	1580	1
Direct Key Lock	4242 34	1110	1	4242 34	1110	1

To be Ordered together as 1 set for 4P SD and 2 sets for 4P TSE.

SD POWER LINE --> Packaging Includes SD, Phase Barriers, Vary Depth Handle.

TSE POWER LINE --> Packaging Includes TSE, Phase Barriers, Inter Source Barrier, Vary Depth Handle, Shorting Links.

EMDX³

SMART
ELECTRICITY
METERS





SUSTAINABLE SAVINGS
FOR YOUR INSTALLATIONS



A meter should be selected according to the network (single-phase or three-phase) and its maximum current, required displayed values and communication type allowing it to be run by a supervision system.



Conforming to standards IEC 61557-12, IEC 62053-21/23, IEC 62052-11, IEC 62052-31, EN 50470-1/3 (for the MID version)

	Cat.No	I _{max} (A)	Width (number of modules)	Non-MID	MID	Output		Dual Tariff	WAGES (Pulse Input)
						Modbus (RS 485)	Pulse		
 Single-phase Direct connection	0 046 70	32	1	x			x		
	4 120 68	45	1	x		x			
	4 120 69	45	1		x		x		
	4 120 80	63	2	x			x		x
	4 120 81	63	2	x		x		o	o
	4 120 82	63	2		x		x		x
	4 120 83	63	2		x	x		o	o
 Three-phase Direct connection	4 120 90	63	4	x			x		x
	4 120 91	63	4	x		x		o	o
	4 120 92	63	4		x		x		x
	4 120 93	63	4		x	x		o	o
	4 120 74	125	6	x		x	x	x	
	4 120 75	125	6		x	x	x	x	
 Three-phase Connection via current transformer	4 120 40	5	4	x			x		x
	4 120 41	5	4	x		x		o	o
	4 120 42	5	4		x		x		x
	4 120 43	5	4		x	x		o	o

 New range

x Built-in

o Dual tariff or 1 pulse input for other meters to connect (water, gas etc.)

The Dual Tariff function allows energy consumption to be measured during different time slots (peak period, off-peak period) or record energy use from two different sources (EB or DG) with a single meter.



Scan to know more about the product.

EMDX³
multi-function meters for
smart distribution board

Din rail mounting

Din Rail Meters for Smart Distribution Board.
 LCD meter with bright graphical back lit display.
 1P / 3P Direct connection or connection with
 CT. Measures kWh as well as other values like
 current, voltage, active energy, power
 etc.

Confirms to Standards: IEC 61557-12; IEC 62053-
 21/23; IEC 62052-11 and IEC 62052-31

MID* compliance ensures accuracy for billing

Dual Tariff meters

WAGES Enabled (1 Pulse input to connect water
 meter, gas meter etc.)

*MID - Measuring Instruments Directive. The
 meters comply to MID, ensures the
 highest levels of reliability and transparency, and in
 order to provide complete
 metrological assurance, applications that
 necessitate the installation of meters
 dedicated to invoicing purposes.

Direct connection

single phase

Cat. Nos	Current Rating (A)	Description	No. of Modules	MRP* ₹ / Unit	Pack
0046 70	32	32A 1P Energy Meter with Pulse Output	1	■	1
4120 68	45	45A 1P Multi Function Meter with RS-485	1	■	1
4120 69	45	45A 1P Multi Function Meter with Pulse Output - MID	1	■	1
4120 80	63	63A 1P Multi Function Meter with WAGES & Pulse Output	2	■	1
4120 82	63	63A 1P Multi Function Meter with WAGES & Pulse Output - MID	2	■	1
4120 81	63	63A 1P Multi Function Meter with Dual Tariff / WAGES & RS-485	2	■	1
4120 83	63	63A 1P Multi Function Meter with Dual Tariff / WAGES & RS-485 - MID	2	■	1



4120 80



4120 91

EMDX³
multi-function meters for
smart distribution board

Cat. Nos	Current Rating (A)	Description	No. of Modules	MRP* ₹ / Unit	Pack
----------	--------------------	-------------	----------------	---------------	------

Direct connection

three phase

4120 90	63	63A 3P Multi Function Meter with WAGES & Pulse Output	4	■	1
4120 92	63	63A 3P Multi Function Meter with WAGES & Pulse Output - MID	4	■	1
4120 91	63	63A 3P Multi Function Meter with Dual Tariff / WAGES & RS-485	4	■	1
4120 93	63	63A 3P Multi Function Meter with Dual Tariff / WAGES & RS-485 - MID	4	■	1
4120 74	125	125A 3P Multi Function Meter with Dual Tariff / WAGES, RS-485 & Pulse Output	6	■	1
4120 75	125	125A 3P Multi Function Meter with Dual Tariff / WAGES, RS-485 & Pulse Output - MID	6	■	1

Connection with CT

4120 40	5	3P with CT Multi Function Meter with WAGES & Pulse Output	4	■	1
4120 42	5	3P with CT Multi Function Meter with WAGES & Pulse Output - MID	4	■	1
4120 41	5	3P with CT Multi Function Meter with Dual Tariff / WAGES & RS-485	4	■	1
4120 43	5	3P with CT Multi Function Meter with Dual Tariff / WAGES & RS-485 - MID	4	■	1

Bold Cat.Nos are products normally available with Legrand (India) Stockists.
 Cat.Nos that are not bold - delivery within 4 - 8 weeks from the date of order.
Bold packing quantity is our mandatory packing. Orders to be placed by
 Legrand (India) Stockist in multiples of the same.

EMDX³ digital panel meter

Cat. Nos	Description	MRP [*] ₹ / Unit	Pack
----------	-------------	------------------------------	------

Modular multi function meter

LCD meter with bright graphical back lit display.
 4 Dedicated Keys (V / I / P Q S / E P F F)
 Precision class 1 / 0.5
 Connection with current transformers (CT)
 Measurement of currents, voltages, frequency, active, reactive and apparent power, power factor, active and reactive energy
 4 tariff metering
 THD voltages, currents and harmonic analysis up to order 25th (available on Modbus COM port)
 Programmable alarms on all functions
 RS 485 and pulse output
 Phase sequence correction diagnostic
 Customized display page

Cat. Nos	Current Rating (A)	Description	No. of Modules	MRP [*] ₹ / Unit	Pack
4120 45	5	Modular Multi Function Meter with THD - RS-485 & Pulse Output CI 1	4	■	1
4120 51	5	4 Tariff Modular Multi Function Meter with Individual THD, Programmable alarms - RS-485 & Pulse Output CI 0.5	4	■	1



4120 51

Pulse concentrator

For collecting and transmitting measurements taken by 12 universal pulse electricity meters.
 Collects pulses from other meters (gas meters, water meters, etc.) RS-485 output

Cat. Nos	Description	No. of Modules	MRP [*] ₹ / Unit	Pack
4120 65	Pulse Concentrator	4	■	1



4120 65

EMDX³ digital panel meter

Cat. Nos	Description	MRP [*] ₹ / Unit	Pack
----------	-------------	------------------------------	------

communication interface

For mounting on door or solid faceplate
 Dimensions: 96 x 96 x 62 mm
 LCD meter with bright graphical back lit display.
 4 Dedicated Keys (V / I / P Q S / E P F F)
 Measurement of currents, voltages, active, reactive and apparent power and power factor

Metering:

- Active energy consumed or produced
- Reactive energy consumed or produced
- Operating time
- Pulses
- THD voltages, currents, and individual harmonic up to order 25(1)
- RS 485 communication and Pulse output
- Phase sequence correction diagnostic
- Optorelays with potential-free SPST-NO contact
- Customized display page

Cat. Nos	Description	MRP [*] ₹ / Unit	Pack
----------	-------------	------------------------------	------

4120 47	Multi Function Meter with THD - RS-485 & Pulse Output CI 1	■	1
4120 52	Advance Multi Function Meter with Individual THD - RS-485 & Pulse Output CI 0.5	■	1



4120 52

Power quality & network analyzer with data logger

Dimensions: 96 x 96 x 62 mm
 LCD meter with bright graphical back lit display.
 Customized display page
 4 Dedicated Keys (V / I / P Q S / E P F F)
 Precision class: 0.5

Measurement of currents, voltages, active, reactive

Bold Cat.Nos are products normally available with Legrand (India) Stockists. Cat.Nos that are not bold - delivery within 4 - 8 weeks from the date of order. Bold packing quantity is our mandatory packing. Orders to be placed by Legrand (India) Stockist in multiples of the same.

EMDX³
power quality & network
analyzer with data logger

Cat. Nos	Description	MRP* ₹ / Unit	Pack
----------	-------------	------------------	------

and apparent power, internal temperature and power factor

Metering:

- active energy consumed or produced
- Reactive energy consumed or produced
- Operating time
- THD
- Programmable alarms on all functions
- Power quality functions: harmonics (U & I) to 50th, dips, swells, interruption, rapid voltage change and flickers
- Memory embedded (8 Mb)
- RTC (real time clock)
- Can take 4 EMDX3 optional modules

Cat. Nos	Description	MRP* ₹ / Unit	Pack
----------	-------------	------------------	------

4120 53	Power Quality & Network Analyzer with Data Logger	■	1
4120 55	R485 communication module with Modbus link	■	1
4120 59	2 Pulse output module for energy count	■	1
4120 57	2 inputs / 2 outputs module	■	1
4120 60	2 analog outputs module	■	1
4120 58	Temperature module	■	1



0046 89

EMDX³
energy management multi-support
web servers

Cat. Nos	Description	MRP* ₹ / Unit	Pack
----------	-------------	------------------	------

RS485 / ethernet

0046 89	IP converter For RS 485/Ethernet conversion for connecting electricity meters and measurement control units to an IP network	■	1
---------	---	---	---

Energy management multi-support web servers

Allow remote configuration, test, control and visualization, via a web browser on PCs, smartphones, web viewers, tablet computers, of data

Features

- In-built IP converter
- Power supply: 9 to 28 V= with the help of a single-phase switching mode power supply Cat.No 1 467 21 to be ordered separately
- With the Legrand Power supervision system, circuit breakers are integrated in a supervision system
- You can therefore check the status of the circuit breakers, measure the electrical values and control the circuit breakers remotely
- MODBUS protocol

Cat. Nos	Description	MRP* ₹ / Unit	Pack
----------	-------------	------------------	------

4149 47	For 10 Modbus addresses or 10 pulse modules	■	1
4149 48	For 32 Modbus addresses or 32 pulse modules	■	1
4149 49	For 255 Modbus addresses or 255 pulse modules Supplied with external power supply and fixing" brackets	■	1



4149 48

PMX

DIGITAL PANEL METERS

FOR ACCURATE
MONITORING AND
ENERGY SAVINGS.



WHY IS PMX PERFECT FOR YOUR FACILITY?



ROBUST

- ✓ Single function meter to advanced level MFM and demand controllers
- ✓ Ensures accurate wiring with ease
- ✓ Cost effective



ADAPTABLE

- ✓ Universal control power supply
- ✓ Site selectable CT/PT ratios
- ✓ Seamless integration with EMS/SCADA



PRECISE

- ✓ True RMS measurement
- ✓ High accuracy class 1 & class 0.5 s
- ✓ Detailed measurements with auto-scaling



Scan to know more about
the product.

PMX digital panel meters

Cat.Nos	Model Series	Description	MRP* ₹ / Unit	Pack
---------	--------------	-------------	------------------	------

PMX 1000 precise single function meters

Features

- **RoHS Compliance**
- True RMS measurement
- High accuracy with class 1 as per IEC 62053-21
- Volts & Amps: $\pm 1.0\%$ of Rated Current.
- **Bright 7 Segment LED display with four digit resolution and 14mm Height**
- Auto and Manual scrolling
- **Site selectable CT/PT ratios**
- Site selectable CT Secondary 1 A/5 A
- **Site selectable 3Phase 4Wire, 3Phase 3Wire & 1Ph configuration**
- Suitable for 50/60 Hz
- Wide range of control power supply 80 - 300 V AC, 40-70 Hz
- Low burden < 0.2 VA per phase Volts & Amps
- Average & Phase wise measurements
- Password protection



4149 77



4149 78

4149 75	PMX 1100	1Ph Ammeter CI 1	1402	1
4149 76	PMX 1200	1Ph Voltmeter CI 1	1402	1
4149 77	PMX 1103	3Ph Ammeter CI 1	2030	1
4149 78	PMX 1203	3Ph Voltmeter CI 1 + Hz	2030	1

PMX 4000 true VAF + PF meter

Features

- **RoHS Compliance**
- **Displays Current, line to neutral & line to line Voltages, frequency & Power Factor. (VA & PF - Phase Wise & Average)**
- **Display on Hours**
- True RMS measurement with simulations sampling of Current & Voltage
- High accuracy with class 1 as per IEC 62053-21 Volts & Amps: $\pm 1.0\%$ of Rated Current.
- **3 Row Display with LED status for different parameter selection.**
- Auto and Manual scrolling
- Site selectable CT/PT ratios
- Site selectable CT Secondary 1 A/5 A
- Site selectable 3Phase 4Wire, 3Phase 3Wire & 1Ph configuration
- Suitable for 50/60 Hz
- Universal control power supply 80 - 300 V AC/DC, 40-70 Hz
- Low burden < 0.2 VA per phase Volts & Amps
- Average & Phase wise measurements
- **Password protection**
- **Seamless integration with EMS/SCADA system with RS485 serial channel communication,**



4149 82

PMX digital panel meters

Cat.Nos	Model Series	Description	MRP* ₹ / Unit	Pack
---------	--------------	-------------	------------------	------

Industry standard Modbus RTU protocol.

4149 79	PMX 4000	3Ph VAF + PF meter CI 1	3444	1
4149 80	PMX 4000	3Ph VAF + PF meter CI 1 with RS485	4110	1



4149 80

PMX 5000 smart energy meters for smart energy billing

Features

- **RoHS Compliance**
- kWh/kVA
- **Old Energy register for back up of last cleared energy values**
- Bright LED with parameter name and value
- Auto scaling capability in adjustment of Kilo, Mega, Giga.
- kWh / kVA / PF / W - any one programmable
- **Positive energy accumulation even with CT polarity reversal with reverse lock program**
- High Accuracy with class 1 as per IEC 62053-21
- Site selectable CT/PT ratios
- Site selectable CT Secondary 1 A/5 A
- Universal control power supply 80 - 300 V AC/DC, 40-70 Hz
- Password protection for tamper proofing
- **Seamless integration with EMS/SCADA system with RS485 serial channel communication, Industry standard Modbus RTU protocol.**
- **Pulse output for integration into a process through PLC/DCS for online energy management**
- Provision for Tamper proofing with meter casing*
*optional strip for tamper proofing.

4149 81	PMX 5000	kWh LED meter CI 1	3946	1
4149 82	PMX 5000	kWh LED meter CI 1 with RS485	4530	1
4149 83	PMX 5000	kWh LED meter CI 1 with Pulse Output	5512	1

PMX 6000 multi dual source meter

Features

- **RoHS Compliance**
- **Bright LED display for showing parameters for both EB & DG**
- **Displays full range of parameters**
Basic : VLL, VLN, A (Avg. & Phase wise), F
Power: W, PF (Avg. & Phase wise)
Energy: Wh
- **Load Hours, Run Hours, Old Wh, Old Load Hours for both EB & DG.**
- **DG Sensing input - 230 VAC**
- Auto scaling capability in adjustment of Kilo, Mega, Giga.
- Positive energy accumulation even with CT polarity reversal with reverse lock program.
- High Accuracy with class 1 as per IEC 62053-21 & class 0.5 as per IEC 62053-22

Bold Cat.Nos are products normally available with Legrand (India) Stockists. Cat.Nos that are not bold - delivery within 4 - 8 weeks from the date of order. Bold packing quantity is our mandatory packing. Orders to be placed by Legrand (India) Stockist in multiples of the same.

* MRP - Maximum Retail Price Inclusive of all taxes including GST.

PMX digital panel meters

Cat.Nos	Model Series	Description	MRP* ₹ / Unit	Pack
---------	--------------	-------------	------------------	------

- Site selectable CT/PT ratios
- Site selectable CT Secondary 1 A/5 A
- Universal control power supply 80 – 300 V AC/DC, 40-70 Hz
- Password protection for tamper proofing
- **Seamless integration with EMS/SCADA system with RS485 serial channel communication, Industry standard Modbus RTU protocol.**
- Provision for Tamper proofing with meter casing*
*optional strip for tamper proofing



4149 85

4149 84	PMX 6000	Dual Source LED meter CI 1 with RS485	7038	1
4149 85	PMX 6000	Dual Source LED meter CI 0.5 with RS485	8390	1

PMX 7000 multifunction meter

Features

- **RoHS Compliance**
- **Bright LED display to view more than 25 parameters.**
- Displays full range of parameters
Basic : VLL, VLN, A (Avg. & Phase Wise), F
Power: W, PF, VA (Avg. & Phase Wise)
Energy: Wh,
- **Load Hours, Run Hours, Old Wh, Old Load Hours**
- Auto scaling capability in adjustment of Kilo, Mega, Giga.
- **Positive energy accumulation even with CT polarity reversal with reverse lock programmable**
- High Accuracy with class 1 as per IEC 62053-21
- Site selectable CT/PT ratios
- Site selectable CT Secondary 1 A/5 A
- Universal control power supply 80 – 300 V AC/DC, 40-70 Hz
- Password protection for tamper proofing
- **Seamless integration with EMS/SCADA system with RS485 serial channel communication, Industry standard Modbus RTU protocol**
- Provision for Tamper proofing with meter casing*
*optional strip for tamper proofing



4149 90



4149 91

4149 90	PMX 7000	MFM (VAF + W/VA/PF/Wh) LED meter CI 1 with RS485 [^]	6672	1
4149 91	PMX 7300	MFM LED meter CI 1	8073	1
4149 92	PMX 7300	MFM LED meter CI 1 with RS485	9632	1

* MRP - Maximum Retail Price Inclusive of all taxes including GST.

PMX digital panel meters

Cat.Nos	Model Series	Description	MRP* ₹ / Unit	Pack
---------	--------------	-------------	------------------	------

PMX 7400

advance multifunction meter / load manager / demand monitor

Features

- **RoHS Compliance**
- **Advance multifunction meter with High/Low recording of VLL, VLN, A, Hz, PF, Var with time stamp.**
- **Voltage & Current THD (Total Harmonics Distortion) with Individual harmonics up to 31st order.**
- **K-factor V & A to keep check on the losses due to harmonic load currents & their effects on transformer heating.**
- Load manager with demand monitoring
- **RTC based Demand management**
- **Import/Export/Net monitoring of Wh, VAh, VARh Inductive/Capacitive, Load hours**
- Auto scaling capability in adjustment of Kilo, Mega, Giga.
- **Positive energy accumulation even with CT polarity reversal with reverse lock programmable**
- High Accuracy with class 1 as per IEC 62053-21 & class 0.5s as per IEC 62053-22
- Site selectable CT/PT ratios
- Site selectable CT Secondary 1 A/5 A
- Universal control power supply 80-300 V AC/DC, 40-70 Hz
- Password protection for tamper proofing
- **Seamless integration with EMS/SCADA system with RS485 serial channel communication, Industry standard Modbus RTU protocol.**
- Byte order option – Field Programmable Float/ Little Endian/ Big Endian data formats

4149 93	PMX 7400	MFM + THD LED meter CI 1 with RS485	12891	1
4149 94	PMX 7400	MFM + THD LED meter CI 0.5 with RS485	15816	1
4149 95	PMX 7410	MFM + THD + Demand monitoring LED meter CI 1 with RS485	18721	1
4149 96	PMX 7420	MFM + THD with Individual + Harmonics + Demand + Import/Export LED meter CI 1 with RS485	19403	1



4149 96

Bold Cat.Nos are products normally available with Legrand (India) Stockists. Cat.Nos that are not bold - delivery within 4 - 8 weeks from the date of order. Bold packing quantity is our mandatory packing. Orders to be placed by Legrand (India) Stockist in multiples of the same.

PMX digital panel meters

Cat.Nos	Model Series	Description	MRP* ₹ / Unit	Pack
4149 97	PMX 7420	MFM + THD with Individual + Harmonics + Demand + Import/Export LED meter CI 0.5s with RS485	22446	1

PMX 8000 advance demand controller

Features

- RoHS Compliance
- Demand controller with 4 relay output
- High memory Data Logger (8MB) for storing multiple parameters.
- Predictive demand with date & time stamping
- Voltage & Current THD (Total Harmonics Distortion) with Individual harmonics up to 31st order.
- K-factor V & A to keep check on the losses due to harmonic load currents & their effects on transformer heating.
- Advance multifunction meter with High/Low recording of VLL, VLN, A, Hz, PF, Var with time stamp.
- RTC based Demand management
- Import/Export/Net monitoring of Wh, VAH, VARh Inductive/Capacitive, Load hours
- Auto scaling capability in adjustment of Kilo, Mega, Giga.
- Positive energy accumulation even with CT polarity reversal with reverse lock programmable
- High Accuracy with class 1 as per IEC 62053-21
- Site selectable CT/PT ratios
- Site selectable CT Secondary 1 A/5 A
- Universal control power supply 80 - 300 V AC/DC, 40-70 Hz
- Password protection for tamper proofing
- Seamless integration with EMS/SCADA system with RS485 serial channel communication, Industry standard Modbus RTU protocol.
- Byte order option - Field Programmable Float/ Little Endian/ Big Endian data formats



4149 98

4149 98	PMX 8000	Demand Controller CI 1 with data logger + Bi directional + THD with Individual Harmonics	43505	1
---------	----------	--	-------	---

* MRP - Maximum Retail Price Inclusive of all taxes including GST.

CTX³ MINI:

AN ULTRA-COMPACT SOLUTION UP TO 16 A



With their compact size, CTX³ MINI are easy to integrate in control panels or distribution boards for switching motors, lighting and heating circuits up to 16 A.



CTX³ MINI: MOUNTING ON DIN RAIL OR ON PLATE

- 1 IP 2X screw terminals
- 2 Integrated auxiliary contact (3P only)
- 3 A1 and A2 supply terminal block



Scan to know more about the product.

CTX³ RTX³ MPX³

UNCOMPROMISING
PERFORMANCE FOR
MOTOR PROTECTION
AND CONTROL



A COMPLETE RANGE OF DEVICES FOR THE PROTECTION AND CONTROL OF MOTORS

CTX³ CONTACTORS AND RTX³ THERMAL RELAYS UP TO 800 A

- Compact size
- High mechanical and electrical endurance for maximum reliability
- Lowest watt loss
- 3-Pole and 4-pole contactors
- Screw terminals
- Complete range of auxiliaries and accessories

MPX³ MOTOR PROTECTION CIRCUIT BREAKERS UP TO 100 A

- High breaking capacity and type 2 coordination for an optimum service level
- Trip class 10
- Sensitive to phase loss
- Compact size
- Can be fixed on 35 mm DIN rail or using screws
- Easy combination with CTX³ 3-pole contactors
- Complete range of control and signalling auxiliaries and accessories



Scan to know more about
the product.

Mini contactors CTX³ 6 to 16 A industrial contactors

Cat.Nos	Max. opt. current AC 3	Max. opt. current AC 1	Control voltage	MRP* ₹ / Unit	Pack
---------	------------------------	------------------------	-----------------	---------------	------

An Ultra Compact Solution Upto 16A (AC3) 3P & 4P

For Switching Motors, Lighting and Heating Circuits
Ultra High Reliability
Ultra High Endurance
Ultra Low Wattloss

Features

Conforms to IEC/EN 60947-4-1
CE & UL Certified
Range From 6A to 16A AC3
Available in 3P & 4P
Click fit accessories
Ultra Compact design
Front and side add on auxiliary contact
Mechanical Interlock unit
mini Thermal Overload Relay

Spare Coils available

RoHS Compliant

3 pole mini contactors

With integrated auxiliary contact
Power terminals: screw terminals

6 A - Integrated auxiliary contact 1 NO

4170 00	6 A	20 A	24 V~	1430	1
4170 01	6 A	20 A	24 V=	1950	1
4170 04	6 A	20 A	110 V~	1430	1
4170 06	6 A	20 A	230 V~	1430	1
4170 09	6 A	20 A	415 V~	1430	1

6 A - Integrated auxiliary contact 1 NC

4170 10	6 A	20 A	24 V~	1430	1
4170 11	6 A	20 A	24 V=	1950	1
4170 14	6 A	20 A	110 V~	1430	1
4170 16	6 A	20 A	230 V~	1430	1
4170 19	6 A	20 A	415 V~	1430	1

9 A - Integrated auxiliary contact 1 NO

4170 20	9 A	20 A	24 V~	1570	1
4170 21	9 A	20 A	24 V=	2080	1
4170 24	9 A	20 A	110 V~	1570	1
4170 26	9 A	20 A	230 V~	1570	1
4170 29	9 A	20 A	415 V~	1570	1

9 A - Integrated auxiliary contact 1 NC

4170 30	9 A	20 A	24 V~	1570	1
4170 31	9 A	20 A	24 V=	2080	1
4170 34	9 A	20 A	110 V~	1570	1
4170 36	9 A	20 A	230 V~	1570	1
4170 39	9 A	20 A	415 V~	1570	1

12 A - Integrated auxiliary contact 1 NO

4170 40	12 A	20 A	24 V~	1700	1
4170 41	12 A	20 A	24 V=	2540	1
4170 44	12 A	20 A	110 V~	1700	1
4170 46	12 A	20 A	230 V~	1700	1
4170 49	12 A	20 A	415 V~	1700	1

12 A - Integrated auxiliary contact 1 NC

4170 50	12 A	20 A	24 V~	1700	1
4170 51	12 A	20 A	24 V=	2540	1
4170 54	12 A	20 A	110 V~	1700	1
4170 56	12 A	20 A	230 V~	1700	1
4170 59	12 A	20 A	415 V~	1700	1

* MRP - Maximum Retail Price Inclusive of all taxes including GST.

Mini contactors CTX³ 6 to 16 A industrial contactors

Cat.Nos	Max. opt. current AC 3	Max. opt. current AC 1	Control voltage	MRP* ₹ / Unit	Pack
---------	------------------------	------------------------	-----------------	---------------	------

16 A - Integrated auxiliary contact 1 NO

4170 60	16 A	20 A	24 V~	2050	1
4170 61	16 A	20 A	24 V=	2940	1
4170 64	16 A	20 A	110 V~	2050	1
4170 66	16 A	20 A	230 V~	2050	1
4170 69	16 A	20 A	415 V~	2050	1

16 A - Integrated auxiliary contact 1 NC

4170 70	16 A	20 A	24 V~	2050	1
4170 71	16 A	20 A	24 V=	2940	1
4170 74	16 A	20 A	110 V~	2050	1
4170 76	16 A	20 A	230 V~	2050	1
4170 79	16 A	20 A	415 V~	2050	1

4-pole mini contactors

Without integrated auxiliary contact
Power terminals: screw terminals

Cat.Nos	Max. opt. current AC 1	Max. opt. current AC 3	Control voltage	MRP* ₹ / Unit	Pack
---------	------------------------	------------------------	-----------------	---------------	------

20 A

4171 40	20 A	16 A	24 V~	1850	1
4171 41	20 A	16 A	24 V=	2350	1
4171 44	20 A	16 A	110 V~	1850	1
4171 46	20 A	16 A	230 V~	1850	1
4171 49	20 A	16 A	415 V~	1850	1

Mini thermal overload relays RTX³ mini

for mini contactors

Cat.Nos	Setting Range	MRP* ₹ / Unit	Pack
---------	---------------	---------------	------

Features

Conforms to IEC/EN 60947-4-1
CE & UL Certified
Thermal protection of circuits against overload, long starting times, and phase failure
Trip Class 10A
Trip Indication
Manual/Automatic Reset
Integrated auxiliary contacts 1 NO & 1 NC

Thermal overload relays for 3 pole mini contactors

Class 10 A - Integrated auxiliary contacts 1 NO + 1 NC

4170 80	0.1~0.16 A	1650	1
4170 81	0.16~0.25 A	1650	1
4170 82	0.25~0.4 A	1650	1
4170 83	0.4~0.63 A	1650	1
4170 84	0.63~1 A	1650	1
4170 85	1~1.6 A	1650	1
4170 86	1.6~2.5 A	1650	1
4170 87	2.5~4 A	1650	1
4170 88	4~6 A	1650	1
4170 89	5~8 A	1650	1
4170 90	6~9 A	1650	1
4170 91	7~10 A	1650	1
4170 92	9~13 A	1650	1
4170 93	12~16 A	1650	1



4170 88

Bold Cat.Nos are products normally available with Legrand (India) Stockists. Cat.Nos that are not bold - delivery within 4 - 8 weeks from the date of order. Bold packing quantity is our mandatory packing. Orders to be placed by Legrand (India) Stockist in multiples of the same.

Mini thermal overload relays

RTX³ mini

accessories for mini Contactors CTX³

Cat.Nos	Setting Range	MRP* ₹ / Unit	Pack
---------	---------------	------------------	------

Add on auxiliary blocks for mini contactors

High Thermal current - 10 A
lth: 10 A

Front mounting

4171 50	1 NO + 1 NC	490	10
4171 51	2 NO	490	10
4171 52	2 NC	490	10
4171 53	4 NO	750	10
4171 54	3 NO + 1 NC	750	10
4171 55	2 NO + 2 NC	750	10
4171 56	1 NO + 3 NC	750	10
4171 57	4 NC	750	10

Side mounting

4171 58	1 NO	490	10
4171 59	1 NC	490	10

Interlock unit

4171 60	Mechanical interlock for mini contactors	780	5
---------	--	-----	---

Spare coils

4171 70	24 V~	860	5
4171 71	24 V=	1170	5
4171 74	110 V~	860	5
4171 76	230 V~	860	5
4171 79	415 V~	860	5

Power contactors CTX³

uncompromising performance for motor protection & control

Range from 9A to 800A (AC3) Contactors

Features

Conforms to IEC/EN 60947-4-1
CE & UL Certified
Extra Mechanical life upto 15 Million
Extra Electrical life upto 2.5 Million
Extra Low Consumption
Compact size
integrated auxiliary contacts

Front safety Cover to prevent dust entry

Direct Clipping on Din Rail

Both Sides Terminal connection

Click fit accessories

Interlocking kits

Spare Coils

RoHS Compliant

3 pole contactors CTX³

9 A to 100 A industrial contactors

Cat.Nos	Max. opt. current AC 3	Max. opt. current AC 1	Control voltage	MRP* ₹ / Unit	Pack
---------	------------------------	------------------------	-----------------	------------------	------

CTX³ 22

With integrated auxiliary contacts
Power terminals: screw terminals

9 A - Integrated auxiliary contacts 1 NO + 1 NC

4160 80	9 A	25 A	24 V~	1530	1
4160 81	9 A	25 A	24 V=	2520	1
4160 82	9 A	25 A	48 V~	1530	1
4160 83	9 A	25 A	48 V=	2520	1
4160 84	9 A	25 A	110 V~	1530	1
4160 86	9 A	25 A	230 V~	1530	1
4160 88	9 A	25 A	380 V~	1530	1
4160 89	9 A	25 A	415 V~	1530	1

* MRP - Maximum Retail Price Inclusive of all taxes including GST.

3 pole contactors CTX³

9 A to 100 A industrial contactors

Cat.Nos	Max. opt. current AC 3	Max. opt. current AC 1	Control voltage	MRP* ₹ / Unit	Pack
---------	------------------------	------------------------	-----------------	------------------	------

12 A - Integrated auxiliary contacts 1 NO + 1 NC

4160 90	12 A	25 A	24 V~	1740	1
4160 91	12 A	25 A	24 V=	2730	1
4160 92	12 A	25 A	48 V~	1740	1
4160 93	12 A	25 A	48 V=	2730	1
4160 94	12 A	25 A	110 V~	1740	1
4160 96	12 A	25 A	230 V~	1740	1
4160 98	12 A	25 A	380 V~	1740	1
4160 99	12 A	25 A	415 V~	1740	1

18 A - Integrated auxiliary contacts 1 NO + 1 NC

4161 00	18 A	40 A	24 V~	2050	1
4161 01	18 A	40 A	24 V=	3330	1
4161 02	18 A	40 A	48 V~	2050	1
4161 03	18 A	40 A	48 V=	3330	1
4161 04	18 A	40 A	110 V~	2050	1
4161 06	18 A	40 A	230 V~	2050	1
4161 08	18 A	40 A	380 V~	2050	1
4161 09	18 A	40 A	415 V~	2050	1

22 A - Integrated auxiliary contacts 1 NO + 1 NC

4161 10	22 A	40 A	24 V~	2520	1
4161 11	22 A	40 A	24 V=	4280	1
4161 12	22 A	40 A	48 V~	2520	1
4161 13	22 A	40 A	48 V=	4280	1
4161 14	22 A	40 A	110 V~	2520	1
4161 16	22 A	40 A	230 V~	2520	1
4161 18	22 A	40 A	380 V~	2520	1
4161 19	22 A	40 A	415 V~	2520	1

CTX³ 40

With integrated auxiliary contacts
Power terminals: screw terminals

32 A - Integrated auxiliary contacts 2 NO + 2 NC

4161 20	32 A	50 A	24 V~	5280	1
4161 21	32 A	50 A	24 V=	9140	1
4161 22	32 A	50 A	48 V~	5280	1
4161 23	32 A	50 A	48 V=	9140	1
4161 24	32 A	50 A	110 V~	5280	1
4161 26	32 A	50 A	230 V~	5280	1
4161 28	32 A	50 A	380 V~	5280	1
4161 29	32 A	50 A	415 V~	5280	1

40 A - Integrated auxiliary contacts 2 NO + 2 NC

4161 30	40 A	60 A	24 V~	7820	1
4161 31	40 A	60 A	24 V=	11450	1
4161 32	40 A	60 A	48 V~	7820	1
4161 33	40 A	60 A	48 V=	11450	1
4161 34	40 A	60 A	110 V~	7820	1
4161 36	40 A	60 A	230 V~	7820	1
4161 38	40 A	60 A	380 V~	7820	1
4161 39	40 A	60 A	415 V~	7820	1

CTX³ 65

With integrated auxiliary contacts

50 A - Integrated auxiliary contacts 2 NO + 2 NC
Screw terminals

4161 40	50 A	70 A	24 V~	9570	1
4161 41	50 A	70 A	24 V=	13180	1
4161 42	50 A	70 A	48 V~	9570	1
4161 43	50 A	70 A	48 V=	13180	1
4161 44	50 A	70 A	110 V~	9570	1
4161 46	50 A	70 A	230 V~	9570	1
4161 48	50 A	70 A	380 V~	9570	1
4161 49	50 A	70 A	415 V~	9570	1

Bold Cat.Nos are products normally available with Legrand (India) Stockists. Cat.Nos that are not bold - delivery within 4 - 8 weeks from the date of order. Bold packing quantity is our mandatory packing. Orders to be placed by Legrand (India) Stockist in multiples of the same.



4171 55



4160 96



4161 26



4161 46

3 pole contactors CTX³ 9 A to 100 A industrial contactors

Cat.Nos	Max. opt. current AC 3	Max. opt. current AC 1	Control voltage	MRP* ₹ / Unit	Pack
65 A - Integrated auxiliary contacts 2 NO + 2 NC Screw terminals					
4161 60	65 A	100 A	24 V~	12720	1
4161 61	65 A	100 A	24 V=	14810	1
4161 62	65 A	100 A	48 V~	12720	1
4161 63	65 A	100 A	48 V=	14810	1
4161 64	65 A	100 A	110 V~	12720	1
4161 66	65 A	100 A	230 V~	12720	1
4161 68	65 A	100 A	380 V~	12720	1
4161 69	65 A	100 A	415 V~	12720	1

CTX³ 100

With integrated auxiliary contacts

75 A - Integrated auxiliary contacts 2 NO + 2 NC
Screw terminals

4161 80	75 A	110 A	24 V~	15790	1
4161 81	75 A	110 A	24 V=	17720	1
4161 82	75 A	110 A	48 V~	15790	1
4161 83	75 A	110 A	48 V=	17720	1
4161 84	75 A	110 A	110 V~	15790	1
4161 86	75 A	110 A	230 V~	15790	1
4161 88	75 A	110 A	380 V~	15790	1
4161 89	75 A	110 A	415 V~	15790	1

85 A - Integrated auxiliary contacts 2 NO + 2 NC
Screw terminals

4162 00	85 A	135 A	24 V~	16350	1
4162 01	85 A	135 A	24 V=	18740	1
4162 02	85 A	135 A	48 V~	16350	1
4162 03	85 A	135 A	48 V=	18740	1
4162 04	85 A	135 A	110 V~	16350	1
4162 06	85 A	135 A	230 V~	16350	1
4162 08	85 A	135 A	380 V~	16350	1
4162 09	85 A	135 A	415 V~	16350	1

100 A - Integrated auxiliary contacts 2 NO + 2 NC
Screw terminals

4162 20	100 A	160 A	24 V~	20370	1
4162 21	100 A	160 A	24 V=	22910	1
4162 22	100 A	160 A	48 V~	20370	1
4162 23	100 A	160 A	48 V=	22910	1
4162 24	100 A	160 A	110 V~	20370	1
4162 26	100 A	160 A	230 V~	20370	1
4162 28	100 A	160 A	380 V~	20370	1
4162 29	100 A	160 A	415 V~	20370	1

3 pole contactors CTX³ 130 A to 800 A industrial contactors

CTX³ 150

With integrated auxiliary contacts

130 A - Integrated auxiliary contacts 2 NO + 2 NC
Screw terminals

4162 40	130 A	160 A	24 V~	30290	1
4162 41	130 A	160 A	24 V=	33280	1
4162 42	130 A	160 A	48 V~	30290	1
4162 43	130 A	160 A	48 V=	33280	1
4162 46	130 A	160 A	100-240 V~/=	30290	1
4162 49	130 A	160 A	400-440 V~	30290	1

150 A - Integrated auxiliary contacts 2 NO + 2 NC
Screw terminals

4162 60	150 A	210 A	24 V~	30700	1
4162 61	150 A	210 A	24 V=	32840	1
4162 62	150 A	210 A	48 V~	30700	1
4162 63	150 A	210 A	48 V=	32840	1

* MRP - Maximum Retail Price Inclusive of all taxes including GST.

3 pole contactors CTX³ 130 A to 800 A industrial contactors

Cat.Nos	Max. opt. current AC 3	Max. opt. current AC 1	Control voltage	MRP* ₹ / Unit	Pack
150 A - Integrated auxiliary contacts 2 NO + 2 NC Screw terminals					
4162 66	150 A	210 A	100-240 V~/=	30700	1
4162 69	150 A	210 A	400-440 V~	30700	1

CTX³ 225

With integrated auxiliary contacts - Screw terminals

185 A - Integrated auxiliary contacts 2 NO + 2 NC

4162 80	185 A	230 A	24 V~/=	38760	1
4162 82	185 A	230 A	48 V~/=	38760	1
4162 86	185 A	230 A	100-240 V~/=	34940	1
4162 89	185 A	230 A	380-450 V~	34940	1

225 A - Integrated auxiliary contacts 2 NO + 2 NC

4162 90	225 A	275 A	24 V~/=	40000	1
4162 92	225 A	275 A	48 V~/=	40000	1
4162 96	225 A	275 A	100-240 V~/=	35360	1
4162 99	225 A	275 A	380-450 V~	35360	1

CTX³ 400

With integrated auxiliary contacts - Screw terminals

265 A - Integrated auxiliary contacts 2 NO + 2 NC

4163 06	265 A	300 A	100-240 V~/=	46370	1
4163 09	265 A	300 A	380-450 V~	46370	1

330 A - Integrated auxiliary contacts 2 NO + 2 NC

4163 16	330 A	350 A	100-240 V~/=	54080	1
4163 19	330 A	350 A	380-450 V~	54080	1

400 A - Integrated auxiliary contacts 2 NO + 2 NC

4163 26	400 A	450 A	100-240 V~/=	66160	1
4163 29	400 A	450 A	380-450 V~	66160	1

CTX³ 800

With integrated auxiliary contacts - Screw terminals

500 A - Integrated auxiliary contacts 2 NO + 2 NC

4163 36	500 A	580 A	200-240 V~/=	99410	1
4163 39	500 A	580 A	380-450 V~	99410	1

630 A - Integrated auxiliary contacts 2 NO + 2 NC

4163 46	630 A	660 A	200-240 V~/=	141560	1
4163 49	630 A	660 A	380-450 V~	141560	1

800 A - Integrated auxiliary contacts 2 NO + 2 NC

4163 56	800 A	900 A	200-240 V~/=	211100	1
4163 59	800 A	900 A	380-450 V~	211100	1

Bold Cat.Nos are products normally available with Legrand (India) Stockists. Cat.Nos that are not bold - delivery within 4 - 8 weeks from the date of order. Bold packing quantity is our mandatory packing. Orders to be placed by Legrand (India) Stockist in multiples of the same.



4161 86



4162 96



4162 46



4163 56

Thermal relays RTX³

for CTX³ 3 pole industrial contactors

Cat.Nos	I min. (A)	I max. (A)	MRP* ₹ / Unit	Pack
---------	---------------	---------------	---------------------	------

Features

Conforms to IEC/EN 60947-4-1

CE & UL Certified

Thermal protection of circuits against overload, long starting times, and phase failure

Trip Class 10A

Trip Indication

Manual/Automatic Reset

Integrated auxiliary contacts 1 NO & 1 NC

Standard type:

- Overload detecting bimetal is used all for three phases

Differential type:

- Standard type characteristics + phase failure protection

Thermal overload relays

Class 10A - Integrated auxiliary contacts 1 NO + 1 NC

RTX³ 40 - for CTX³ 22 and 40

Standard type with screw terminals

4166 40	0.1	0.16	2060	1
4166 41	0.16	0.25	2060	1
4166 42	0.25	0.4	2060	1
4166 43	0.4	0.63	2060	1
4166 44	0.63	1	2060	1
4166 45	1	1.6	2060	1
4166 46	1.6	2.5	2060	1
4166 47	2.5	4	2060	1
4166 48	4	6	2060	1
4166 49	5	8	2060	1

RTX³ 40 - for CTX³ 22 and 40

Standard type with screw terminals

4166 50	6	9	2060	1
4166 51	7	10	2060	1
4166 52	9	13	2060	1
4166 53	12	18	2060	1
4166 54	16	22	2150	1
4166 55	18	25	2180	1
4166 56	22	32	2470	1
4166 57	28	40	2660	1



4167 31



4167 65

Thermal relays RTX³

for CTX³ 3 pole industrial contactors

Cat.Nos	I min. (A)	I max. (A)	MRP* ₹ / Unit	Pack
---------	---------------	---------------	---------------------	------

RTX³ 40 - for CTX³ 22 and 40

Differential type with screw terminals

4166 60	0.1	0.16	2510	1
4166 61	0.16	0.25	2510	1
4166 62	0.25	0.4	2510	1
4166 63	0.4	0.63	2540	1
4166 64	0.63	1	2540	1
4166 65	1	1.6	2540	1
4166 66	1.6	2.5	2540	1
4166 67	2.5	4	2540	1
4166 68	4	6	2550	1
4166 69	5	8	2550	1
4166 70	6	9	2550	1
4166 71	7	10	2550	1
4166 72	9	13	2550	1
4166 73	12	18	2670	1
4166 74	16	22	2670	1
4166 75	18	25	2670	1
4166 76	22	32	3250	1
4166 77	28	40	3250	1

RTX³ 65 - for CTX³ 65

Standard type with screw terminals

4166 83	9	13	4140	1
4166 84	12	18	4140	1
4166 85	16	22	4140	1
4166 86	18	25	4140	1
4166 87	24	36	4140	1
4166 88	28	40	4140	1
4166 89	34	50	4140	1
4166 90	45	65	4140	1

RTX³ 100 - for CTX³ 100

Standard type with screw terminals

4167 23	18	25	6700	1
4167 24	24	36	6700	1
4167 25	28	40	6700	1
4167 26	34	50	6700	1
4167 27	45	65	6700	1
4167 28	54	75	6700	1
4167 29	63	85	6700	1
4167 30	70	95	6700	1
4167 31	80	100	6700	1

RTX³ 150 - for CTX³ 150

Standard type with screw terminals

4167 60	45	65	9860	1
4167 61	54	75	9860	1
4167 62	63	85	9860	1
4167 63	80	105	9860	1
4167 64	95	130	9860	1
4167 65	110	150	9860	1

* MRP - Maximum Retail Price Inclusive of all taxes including GST.

Bold Cat.Nos are products normally available with Legrand (India) Stockists. Cat.Nos that are not bold - delivery within 4 - 8 weeks from the date of order. Bold packing quantity is our mandatory packing. Orders to be placed by Legrand (India) Stockist in multiples of the same.

Thermal relays RTX³

for CTX³ 3 pole industrial contactors

Cat.Nos	Description	MRP* ₹ / Unit	Pack
---------	-------------	------------------	------

Separate mounting units

To mount the relays separately from contactors, on DIN rail or panel by fixing screws

4165 91	For RTX ³ 40 up to 32 A	770	1
4165 92	For RTX ³ 40 40 A	770	1
4165 93	For RTX ³ 65 with screw terminals	950	1
4165 94	For RTX ³ 65 with cage terminals	950	1
4165 95	For RTX ³ 100 with screw terminals	1210	1
4165 96	For RTX ³ 100 with cage terminals	1210	1
4165 97	For RTX ³ 150 with screw terminals	1910	1
4165 98	For RTX ³ 150 with cage terminals	1910	1

Thermal overload relays

Class 10 A - Integrated auxiliary contacts 1 NO + 1 NC

Cat.Nos	I min. (A)	I max. (A)	MRP* ₹ / Unit	Pack
---------	------------	------------	------------------	------

RTX³ 225 - for CTX³ 225

Differential type with screw terminals

4167 80	65	100	13400	1
4167 81	85	125	13400	1
4167 82	100	160	14860	1
4167 83	120	185	14860	1
4167 84	160	240	15430	1



4167 84

RTX³ 400 - for CTX³ 400

Differential type with screw terminals

4167 86	85	125	19670	1
4167 87	100	160	19670	1
4167 88	120	185	19670	1
4167 89	160	240	19670	1
4167 90	200	330	19670	1
4167 91	260	400	19670	1

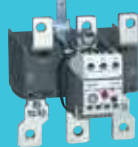

4167 91

RTX³ 800 - for CTX³ 800

Differential type with screw terminals

4167 92	200	300	30600	1
4167 93	260	400	30600	1
4167 94	400	630	30600	1
4167 95	520	800	30600	1



4164 36

4-pole contactors CTX³

40 A to 900 A industrial contactors and spare coils

Cat.Nos	Max. opt. current AC 1	Max. opt. current AC 3	Control voltage	MRP* ₹ / Unit	Pack
---------	------------------------	------------------------	-----------------	------------------	------

Contactors CTX³

Power terminals: screw terminals

Without integrated auxiliary contact

4164 26	40 A	22 A	230 V~	3320	1
4164 36	60 A	40 A	230 V~	8250	1
4164 46	100 A	65 A	230 V~	14170	1
4164 56	135 A	85 A	230 V~	17430	1



4164 56

* MRP - Maximum Retail Price Inclusive of all taxes including GST.

4-pole contactors CTX³

40 A to 900 A industrial contactors and spare coils

Cat.Nos	Max. opt. current AC 1	Max. opt. current AC 3	Control voltage	MRP* ₹ / Unit	Pack
---------	------------------------	------------------------	-----------------	------------------	------

With integrated auxiliary contacts

Auxiliary contacts: 2 NO + 2 NC

4164 66	165 A	130 A	100-240 V~/=	28890	1
4164 76	250 A	150 A	100-240 V~/=	38810	1
4164 86	330 A	225 A	100-240 V~/=	43190	1
4164 96	420 A	330 A	100-240 V~/=	79860	1
4165 06	500 A	400 A	100-240 V~/=	87380	1
4165 16	750 A	630 A	200-240 V~/=	175650	1
4165 26	900 A	800 A	200-240 V~/=	212360	1



4164 86

Spare coils for CTX³ 4P contactors

Cat.Nos	Description	MRP* ₹ / Unit	Pack
---------	-------------	------------------	------

Control voltage 230 V~

4165 46	For CTX ³ 40 A to 60 A (AC-1)	1630	1
4165 56	For CTX ³ 100 A to 135 A (AC-1)	1930	1
4165 66	For CTX ³ 165 A to 330 A (AC-1)	10150	1
4165 76	For CTX ³ 420 A to 500 A (AC-1)	18950	1
4165 86	For CTX ³ 750 A to 900 A (AC-1)	28430	1

CTX³ add-on auxiliary contact blocks

Front mounting

For CTX³ 3P form 9 A to 150 A (AC-3) and CTX³ 4P from 40 A to 135 A (AC-1) - 2 and 4 pole - lth: 16 A

4168 50	1 NO + 1 NC	510	10
4168 51	2 NO	510	10
4168 52	2 NC	510	10
4168 53	4 NO	810	10
4168 54	3 NO + 1 NC	810	10
4168 55	2 NO + 2 NC	810	10
4168 56	1 NO + 3 NC	810	10
4168 57	4 NC	810	10



4168 50



4168 55

Side mounting

2 pole - Mounting on both sides

4168 58	For CTX ³ 3P Form 9 A to 150 A (AC-3) 1 NO + 1 NC - lth: 16 A	890	10
4168 59	For CTX ³ 3P Form 185 A to 800 A (AC-3) and CTX ³ 4P from 165 A to 900 A (AC-1) 1 NO + 1 NC - lth: 16 A	890	10
4168 49	For CTX ³ 4P From 40 A to 135 A (AC-1) 1 NO + 1 NC - lth: 16 A	890	10

Bold Cat.Nos are products normally available with Legrand (India) Stockists. Cat.Nos that are not bold - delivery within 4 - 8 weeks from the date of order. Bold packing quantity is our mandatory packing. Orders to be placed by Legrand (India) Stockist in multiples of the same.

4-pole contactors CTX³

40 A to 900 A industrial contactors and spare coils



Cat.Nos	Description	MRP* ₹ / Unit	Pack
---------	-------------	------------------	------

CTX³ time delay blocks

For CTX³ 3P from 9 A to 150 A (AC-3)

Time delay: 1 to 30 s

Front mounting

On delay

4168 70	24-48 V~/=	2370	1
4168 71	110-230 V~	2370	1

Off delay

4168 72	24-48 V~/=	3250	1
4168 73	110-230 V~	3100	1

CTX³

capacitor switching units Cat.Nos 4168 74/75/76/77

Capacitor unit is connected to the terminals of the contactor to reduce the high inrush current.

IEC 60947-4-1 AC 6b

Type	Contactor		Maximum operating power (kVAr)			Max. Peak current (A)
			220 - 240 V	400 - 480 V	500 - 550 V	
4168 74	CTX ³ 22	9 A	5	9.7	14	560
	CTX ³ 22	12 A	6.7	12.5	18	560
	CTX ³ 22	18 A	8.5	16.7	24	850
	CTX ³ 22	22 A	10	18	26	1250
	CTX ³ 40	32 A	15	25	36	1900
4168 75/76	CTX ³ 40	40 A	20	33.3	48	2160
	CTX ³ 65	50 A	20	40	58	2160
4168 77	CTX ³ 65	65 A	25	45.7	66	3040
	CTX ³ 100	75 A	29.7	54	78	3040
	CTX ³ 100	85 A	35	60	92	3040
Without Capacitor Switching Unit as per IEC 60947-4-1 AC 6b	CTX ³ 100	100 A	37	62	94	3040
	CTX ³ 150	150 A		70		3300
	CTX ³ 225	185 A		84	120	3500
	CTX ³ 225	225 A		115	130	4000
	CTX ³ 400	265 A		125	140	5000
	CTX ³ 400	330 A		139	185	6500
	CTX ³ 400	400 A		185	195	8000
	CTX ³ 800	500 A		220	330	10000
	CTX ³ 800	630 A		291	340	12000
CTX ³ 800	800 A		369	370	14200	

Note:

- When the switch is closed capacitor must be discharged before recharged. (Maximum residual voltage at terminals ≤ 50 V)
- To prevent short current, gG type fuse must be 1.5 - 2 times than rated current

CTX³ accessories

CTX³ capacitor switching units

AC-6b

Operating power from 9.7 kVAr to 62 kVAr (400/440 V)

4168 74	For contactors CTX ³ 3P from 9 to 40 A, upto 33.3 kVAr at 440 V / 48 kVAr at 525 V	2250	1
---------	---	------	---

* MRP - Maximum Retail Price Inclusive of all taxes including GST.

CTX³ accessories

Cat.Nos	Description	MRP* ₹ / Unit	Pack
---------	-------------	------------------	------

CTX³ capacitor switching units

4168 75	For contactors CTX ³ 3P 50 and 65 A with screw terminals upto 45.7 kVAr at 440 V / 66 kVAr at 525 V	3070	1
4168 76	For contactors CTX ³ 3P 50 and 65 A with cage terminals upto 45.7 kVAr at 440 V / 66 kVAr at 525 V	3320	1
4168 77	For contactors CTX ³ 3P 75 to 100 A with screw terminals upto 62 kVAr at 440 V / 94 kVAr at 525 V	3320	1

CTX³ interlocking

Component parts for assembling by customer

Horizontal mounting

Interlock units

4168 79	Mechanical interlocks for CTX ³ 4P from 40 to 135 A (AC-1)	1350	5
---------	---	------	---

Interlock units

4168 80	Mechanical interlocks for CTX ³ 3P from 9 to 150 A Provides 2 NC contacts for use in electrical interlocking	2730	1
4168 87	Mechanical interlocks for CTX ³ 3P from 185 to 400 A and CTX ³ 4P from 165 to 500 A	4740	1

Interlock units

4168 88	Mechanical interlocks for CTX ³ 3P from 500 to 800 A	6340	1
4168 89	Mechanical interlocks for CTX ³ 4P from 750 to 900 A	6700	1

Wire kits

Used for making reversing between two 3P contactors

4168 82	For CTX ³ 22	1380	5
4168 83	For CTX ³ 40	1870	5
4168 84	For CTX ³ 65	2300	5
4168 85	For CTX ³ 100	3850	5

Bold Cat.Nos are products normally available with Legrand (India) Stockists. Cat.Nos that are not bold - delivery within 4 - 8 weeks from the date of order. **Bold packing quantity** is our mandatory packing. Orders to be placed by Legrand (India) Stockist in multiples of the same.

CTX³ accessories



4168 91

Cat.Nos	Description	MRP* ₹ / Unit	Pack
---------	-------------	------------------	------

Boxes for motor starter

For CTX³ 22 equipped with RTX³ 40 (0.1 - 22 A)

4168 90	Without pushbuttons	3510	1
4168 91	With pushbuttons	4310	1

CTX³ transient voltage suppressor blocks

Absorbs the surge arisen out of the coil of the contactor



4168 97

4168 95	24-48 V~/=	680	10
4168 96	100-125 V~/=	680	10
4168 97	200-240 V~/=	680	10
4168 98	380-400 V~	680	10

CTX³ terminals covers

4168 42	For CTX ³ 3P from 185 to 225 A (AC-3)	620	5
4168 43	For CTX ³ 3P from 265 to 400 A (AC-3)	920	5
4168 44	For CTX ³ 3P from 500 to 900 A (AC-3)	1390	5
4168 45	For CTX ³ 4P from 165 to 330 A (AC-1)	770	5
4168 46	For CTX ³ 4P from 420 to 500 A (AC-1)	1170	5
4168 47	For CTX ³ 4P from 750 to 900 A (AC-1)	1980	5



4168 40

CTX³ safety front cover

4168 40	For CTX ³ 3P from 9 to 150 A (AC-3) and CTX ³ 4P from 40 to 135 A (AC-1)	40	50
4168 41	For CTX ³ 3P from 85 to 800 A (AC-3) and CTX 4P from 165 to 900 A (AC-1)	160	50

Distant reset flexible cables for thermal relays

4168 92	400 mm	1160	1
4168 93	500 mm	1260	1
4168 94	600 mm	1280	1

CTX³ spare coils

Spare coils for CTX³ 3P contactors

For CTX³ 22

4169 00	24 V~	870	5
4169 02	48 V~	870	5
4169 04	110 V~	870	5
4169 06	230 V~	870	5
4169 08	380 V~	870	5
4169 09	415 V~	870	5

* MRP - Maximum Retail Price Inclusive of all taxes including GST.

CTX³ accessories

Cat.Nos	Description	MRP* ₹ / Unit	Pack
---------	-------------	------------------	------

For CTX³ 40

4169 20	24 V~	870	5
4169 21	24 V=	870	5
4169 22	48 V~	870	5
4169 23	48 V=	870	5
4169 24	110 V~	870	5
4169 26	230 V~	870	5
4169 28	380 V~	870	5
4169 29	415 V~	870	5

For CTX³ 65

4169 30	24 V~	1340	5
4169 31	24 V=	1340	5
4169 32	48 V~	1340	5
4169 33	48 V=	1340	5
4169 34	110 V~	1340	5
4169 36	230 V~	1340	5
4169 38	380 V~	1340	5
4169 39	415 V~	1340	5

For CTX³ 100

4169 40	24 V~	1640	3
4169 41	24 V=	1640	3
4169 42	48 V~	1640	3
4169 43	48 V=	1640	3
4169 44	110 V~	1640	3
4169 46	230 V~	1640	3
4169 48	380 V~	1640	3
4169 49	415 V~	1640	3

For CTX³ 150

4169 50	24 V~	6200	1
4169 51	24 V=	6200	1
4169 52	48 V~	6200	1
4169 53	48 V=	6200	1
4169 56	100-240 V~/=	6200	1
4169 59	400-440 V~	6200	1

Bold Cat.Nos are products normally available with Legrand (India) Stockists. Cat.Nos that are not bold - delivery within 4 - 8 weeks from the date of order. Bold packing quantity is our mandatory packing. Orders to be placed by Legrand (India) Stockist in multiples of the same.

auxillary contactor / control relays CTX³



4169 66

Cat.Nos	Description	MRP* ₹ / Unit	Pack
---------	-------------	---------------------	------

For CTX³ 225

4169 60	24 V~/=	8960	1
4169 62	48 V~/=	8960	1
4169 66	100-240 V~/=	8960	1
4169 69	400-440 V~	8960	1

For CTX³ 400

4169 76	100-240 V~/=	13480	1
4169 79	380-450 V~	13480	1

For CTX³ 800

4169 86	200-240 V~/=	29350	1
4169 89	380-450 V~	29350	1

Auxillary contactor / control relays CTX³

4 pole

Conform to IEC 60 947-1, IEC 60 947-4-1 and IEC 60 947-5-1 for the auxiliary contacts

CE & UL Certified

Ultra High Ith = 10 A

Ultra Low consumption coil

Click fit accessories

Spare Coils available

RoHS Compliant

CTX³ control relays

4 NO

4168 00	24 V~	1760	1
4168 01	24 V=	2670	1
4168 02	48 V~	1760	1
4168 03	48 V=	2670	1
4168 04	110 V~	1760	1
4168 06	230 V~	1760	1
4168 09	415 V~	1760	1

3 NO + 1 NC

4168 10	24 V~	1760	1
4168 11	24 V=	2670	1
4168 12	48 V~	1760	1
4168 13	48 V=	2670	1
4168 14	110 V~	1760	1
4168 16	230 V~	1760	1
4168 19	415 V~	1760	1



4168 10

* MRP - Maximum Retail Price Inclusive of all taxes including GST.

Accessories for auxiliary contactor / control relays

Cat.Nos	Description	MRP* ₹ / Unit	Pack
---------	-------------	---------------------	------

2 NO + 2 NC

4168 20	24 V~	1760	1
4168 21	24 V=	2690	1
4168 22	48 V~	1760	1
4168 23	48 V=	2670	1
4168 24	110 V~	1760	1
4168 26	230 V~	1760	1
4168 29	415 V~	1760	1

High thermal current - 10 A

Ith : 10 A

Front mounting

4171 50	1 NO + 1 NC	490	10
4171 51	2 NO	490	10
4171 52	2 NC	490	10
4171 53	4 NO	750	10
4171 54	3 NO + 1 NC	750	10
4171 55	2 NO + 2 NC	750	10
4171 56	1 NO + 3 NC	750	10
4171 57	4 NC	750	10

Side mounting

4171 58	1 NO	490	10
4171 59	1 NC	490	10

Interlock Unit

4171 60	Mechanical interlock	780	5
---------	----------------------	-----	---

Spare coils

4171 70	24 V~	860	5
4171 71	24 V=	1170	5
4171 74	110 V~	860	5
4171 76	230 V~	860	5
4171 79	415 V~	860	5

Bold Cat.Nos are products normally available with Legrand (India) Stockists. Cat.Nos that are not bold - delivery within 4 - 8 weeks from the date of order. **Bold packing quantity** is our mandatory packing. Orders to be placed by Legrand (India) Stockist in multiples of the same.

CX³

Modular Power Contactors for your switching needs



412544



412556

- Manual handle for permanent OFF / ON
- Manual Override for test & Repair
- Confirms to IEC 61095 & IEC 60947 -4-1
- RoHs Compliance



Scan to know more about the product.

CX³ contactors

Cat.Nos	Description	MRP* ₹ / Unit	Pack
---------	-------------	------------------	------

Power contactors CX³

Conform to IEC/EN 61095
Space for power supply busbar on top (up to 25 A)

4125 44	25 A 2 NO contactor	2580	1
4125 45	40 A 2 NO contactor	4400	1
4125 47	63 A 2 NO contactor	5120	1
4125 48	63 A 2 NC contactor	5120	1
4125 49	40 A 3 NO contactor	7360	1
4125 50	63 A 3 NO contactor	8320	1
4125 51	25 A 4 NO contactor	3040	1
4125 53	40 A 4 NO contactor	7770	1
4125 56	63 A 4 NO contactor	9200	1
4125 57	63 A 4 NC contactor	9280	1

Signalling auxiliaries for contactors

Auxiliary changeover switch

4124 29	For 1 module contactors 16 A to 25 A	3780	1
4124 30	For 2 module contactors 25 A	3790	1

* MRP - Maximum Retail Price Inclusive of all taxes including GST.



4173 08

MPCBs MPX³

Cat.Nos	Rated 3Ph Motor	Magnetic release operating current (A)	MRP* ₹ / Unit	Pack
---------	-----------------	--	------------------	------

motor protection circuit breakers from 0.16 A to 100 A upto 45 KW

Maximum efficiency in a compact unit

Conform to IEC 60947-1, IEC 60947-2, IEC 60947-4

Adjustable thermal release

Magnetic release 13 le max

High breaking capacity

toggle handle

Fixing on rail or by screw

Wide range of accessories

Undervoltage Release

Shunt Release

Auxillary Contacts

IP 65 Enclosure

Thermal magnetic MPCBs

Adjustable thermal release Magnetic release 13 le max.

MPX³ 32S - 3P

Standard breaking capacity with toggle handle

Fixing on rail

415 V breaking capacity Icu (kA) - 100

Cat.Nos	Rated 3Ph Motor (KW)	Thermal release adj. range (A)	Magnetic release operating current (A)	MRP* ₹ / Unit	Pack
---------	----------------------	--------------------------------	--	------------------	------

4173 00	0.02	0.1 to 0.16	2.1	4060	1
4173 01	0.06	0.16 to 0.25	3.3	4060	1
4173 02	0.09	0.25 to 0.4	5.2	4060	1
4173 03	0.12	0.4 to 0.63	8.2	4720	1
4173 04	0.18 / 0.25	0.63 to 1	13	4720	1
4173 05	0.37 / 0.55	1 to 1.6	20.8	4750	1
4173 06	0.75	1.6 to 2.5	32.5	4840	1
4173 07	1.5	2.5 to 4	52	4920	1
4173 08	2.2	4 to 6	78	4940	1
4173 09	3	5 to 8	104	4940	1

415 V breaking capacity Icu (kA) - 50

4173 10	4	6 to 10	130	4940	1
4173 11	5.5	9 to 13	169	4990	1

415 V breaking capacity Icu (kA) - 20

4173 12	7.5	11 to 17	221	5870	1
---------	-----	----------	-----	------	---

415 V breaking capacity Icu (kA) - 15

4173 13	7.5	14 to 22	286	6230	1
4173 14	11	18 to 26	338	6700	1
4173 15	15	22 to 32	416	11130	1

Bold Cat.Nos are products normally available with Legrand (India) Stockists. Cat.Nos that are not bold - delivery within 4 - 8 weeks from the date of order. **Bold packing quantity** is our mandatory packing. Orders to be placed by Legrand (India) Stockist in multiples of the same.

MPCBs MPX³

Cat.Nos	Description	MRP* ₹ / Unit	Pack
---------	-------------	---------------------	------

MPX³ 32H - 3P

High breaking capacity with rotary handle
415 V breaking capacity Icu (kA) - 100

4173 20	0.02	0.1 to 0.16	2.1	5010	1
4173 21	0.06	0.16 to 0.25	3.3	5010	1
4173 22	0.09	0.25 to 0.4	5.2	5010	1
4173 23	0.12	0.4 to 0.63	8.2	5500	1
4173 24	0.18 / 0.25	0.63 to 1	13	5500	1
4173 25	0.37/ 0.55	1 to 1.6	20.8	5500	1
4173 26	0.75	1.6 to 2.5	32.5	5500	1
4173 27	1.5	2.5 to 4	52	5670	1
4173 28	2.2	4 to 6	78	5690	1
4173 29	3	5 to 8	104	6150	1
4173 30	4	6 to 10	130	6210	1
4173 31	5.5	9 to 13	169	6820	1

415 V breaking capacity Icu (kA) - 50

4173 32	7.5	11 to 17	221	7300	1
4173 33	7.5	14 to 22	286	8540	1
4173 34	11	18 to 26	338	8620	1
4173 35	15	22 to 32	416	13380	1

MPX³ 63H - 3P

High breaking capacity with rotary handle
Fixing on rail or by screw
415 V breaking capacity Icu (kA) - 100

4173 60	4	6 to 10	130	12990	1
4173 61	5.5	9 to 13	169	12990	1

415 V breaking capacity Icu (kA) - 50

4173 62	7.5	11 to 17	221	12990	1
4173 63	7.5	14 to 22	286	14720	1
4173 64	11	18 to 26	338	14720	1
4173 65	15	22 to 32	416	14720	1
4173 66	18.5	28 to 40	520	16450	1
4173 67	22	34 to 50	650	20210	1
4173 68	30	45 to 63	819	21560	1

MPX³ 100H - 3P

High breaking capacity with rotary handle
Fixing on rail or by screw
415 V breaking capacity Icu (kA) - 100

4173 70	7.5	11 to 17	221	17950	1
4173 71	7.5	14 to 22	286	17950	1
4173 72	11	18 to 26	338	17950	1



4173 68

MPCBs MPX³

Cat.Nos	Description	MRP* ₹ / Unit	Pack
---------	-------------	---------------------	------

Used to connect MPX³ directly with the contactor

4173 73	15	22 to 32	416	17950	1
4173 74	18.5	28 to 40	520	17950	1
4173 75	22	34 to 50	650	21340	1
4173 76	30	45 to 63	819	22370	1

415 V breaking capacity Icu (kA) - 75

4173 77	37	55 to 75	975	24050	1
4173 78	45	70 to 90	1170	24050	1
4173 79	45	80 to 100	1300	24050	1



4173 79

Magnetic only MPCBs

Without thermal release
Magnetic release 13 x Ie max.

MPX³ 32MA - 3P

High breaking capacity with rotary handle
Fixing on rail
415 V breaking capacity Icu (kA) - 100

4173 40	0.02	2.1	4590	1
4173 41	0.06	3.3	4590	1
4173 42	0.09	5.2	4590	1
4173 43	0.12	8.2	5110	1
4173 44	0.18 / 0.25	13	5110	1
4173 45	0.37 / 0.55	20.8	5110	1
4173 46	0.75	32.5	5110	1
4173 47	1.5	52	5180	1
4173 48	2.2	78	5180	1
4173 49	3	104	5180	1
4173 50	4	130	5460	1
4173 51	5.5	169	5800	1

415 V breaking capacity Icu (kA) - 50

4173 52	7.5	221	7470	1
4173 53	7.5	286	7470	1
4173 54	11	338	7470	1
4173 55	15	416	12350	1



4173 48

MPCBs MPX³ accessories

Cat.Nos	Description	MRP* ₹ / Unit	Pack
---------	-------------	---------------------	------

Auxiliary contacts

2 pole

Side mounting

Mounting on the left side of MPCBs
Two auxiliary contacts per MPCB

4174 00	1 NO + 1 NC	980	5
4174 01	2 NO	980	5
4174 02	2 NC	980	5



4174 00

Front mounting

One auxiliary contact per MPCB

4174 03	1 NO + 1 NC	1010	5
4174 04	2 NO	1010	5
4174 05	2 NC	1010	5

* MRP - Maximum Retail Price Inclusive of all taxes including GST.

Bold Cat.Nos are products normally available with Legrand (India) Stockists. Cat.Nos that are not bold - delivery within 4 - 8 weeks from the date of order. Bold packing quantity is our mandatory packing. Orders to be placed by Legrand (India) Stockist in multiples of the same.

MPCBs MPX³ accessories

Cat.Nos	Description	MRP* ₹ / Unit	Pack
---------	-------------	---------------------	------

Alarm contacts

1 NO + 1 NC

Any trip alarm contact

Operates in case of trip

Mounting on the left side of MPCBs

Set alarm contact first in case of using auxiliary contact together (MPX³ 63H can not accept auxiliary contact and alarm contact together)

4174 06	For MPX ³ 32	1590	1
4174 08	For MPX ³ 63 and 100	1590	1

Magnetic trip alarm contact

Operates in case of instantaneous trip

Mounting on the left side of MPCBs

Set alarm contact first in case of using auxiliary contact together

4174 07	1 NO + 1 NC	1590	1
---------	-------------	------	---

Shunt release

Mounting on the right side of MPCBs

One release per MPCB

4174 10	24 V~ 50 Hz / 28 V~ 60 Hz	2520	1
4174 11	110 V~ 50 Hz / 120 V~ 60 Hz	2520	1
4174 12	220-230 V~ 50 Hz / 240-260 V~ 60 Hz	2520	1
4174 13	380-400 V~ 50 Hz / 440-460 V~ 60 Hz	2520	1

Undervoltage release

Mounting on the right side of MPCBs

One release per MPCB

Without auxiliary contact

4174 20	24 V~ 50 Hz / 28 V~ 60 Hz	2520	1
4174 21	110 V~ 50 Hz / 120 V~ 60 Hz	2520	1
4174 22	220-230 V~ 50 Hz / 240-260 V~ 60 Hz	2520	1



4174 12



4174 22

MPCBs MPX³ accessories

Cat.Nos	Description	MRP* ₹ / Unit	Pack
---------	-------------	---------------------	------

4174 23	380-400 V~ 50 Hz / 440-460 V~ 60 Hz	2520	1
---------	--	------	---

With 2 NO auxiliary contacts

Can not attach to MPX³ 32S

4174 30	24 V~ 50 Hz / 28 V~ 60 Hz	3360	1
4174 31	110 V~ 50 Hz / 120 V~ 60 Hz	3360	1
4174 32	220-230 V~ 50 Hz / 240-260 V~ 60 Hz	3360	1
4174 33	380-400 V~ 50 Hz / 440-460 V~ 60 Hz	3360	1

Dial cover

Sealable cover to protect the set value from the operation that is not intended

Without auxiliary contact

4174 79	For all types of MPX ³	110	50
---------	-----------------------------------	-----	----

Direct adaptor and mounting unit

For mounting CTX³ contactors under MPX³ MPCBs

Direct adaptators

Used to connect MPX³ directly with the contactor

4174 40	For MPX ³ 32S with CTX ³ mini AC	590	2
4174 41	For MPX ³ 32S with CTX ³ mini DC	590	2
4174 42	For MPX ³ 32H/32MA with CTX ³ mini AC	590	2
4174 43	For MPX ³ 32H/32MA with CTX ³ mini DC	590	2
4174 48	For MPX ³ 32S with CTX ³ 22 AC	700	2

MPCBs MPX³ accessories

Cat.Nos	Description	MRP* ₹ / Unit	Pack
4174 49	For MPX ³ 32S with CTX ³ 22 DC	700	2
4174 50	For MPX ³ 32H/32MA with CTX ³ 22 AC	700	2

Direct adaptators

Used to connect MPX³ directly with the contactor

4174 51	For MPX ³ 32H/32MA with CTX ³ 22 DC	700	2
4174 52	For MPX ³ 32S with CTX ³ 40 AC	860	2
4174 53	For MPX ³ 32S with CTX ³ 40 DC	860	2
4174 54	For MPX ³ 32H/32MA with CTX ³ 40 AC	860	2
4174 55	For MPX ³ 32H/32MA with CTX ³ 40 DC	860	2
4174 56	For MPX ³ 63H with CTX ³ 65 AC with cage type terminals	1030	2
4174 57	For MPX ³ 63H with CTX ³ 65 DC with cage type terminals	1030	2
4174 58	For MPX ³ 100H with CTX ³ 100 AC with cage type terminals	1030	1
4174 59	For MPX ³ 100H with CTX ³ 100 DC with cage type terminals	1030	1

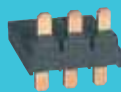

4174 56



4174 61



4174 63



4174 73



4174 81

Mounting unit

This device is used for joining together MPX³ MCPBs and CTX³ contactors

4174 60	For MPX ³ 32S/32H/32MA	800	2
---------	-----------------------------------	-----	---

MPCBs MPX³ accessories

Cat.Nos	Description	MRP* ₹ / Unit	Pack
4174 61	For MPX ³ 63H	1470	1
4174 62	For MPX ³ 100H	1770	1

Rotary handle

Mounting on panel's door to control the MPX³

4174 63	For MPX ³ 32H and 32 MA	2080	1
4174 64	For MPX ³ 63H	2080	1
4174 65	For MPX ³ 100H	2640	1

Phase busbar

For parallel connection of MPX³

For MPX³ 32S, 32H and 32MA

Rated current 63 A

4174 71	2 devices	820	5
4174 73	3 devices	2060	5
4174 75	4 devices	2060	5
4174 76	5 devices	2060	5
4174 77	Feeder for phase busbar 32 A	570	5

For MPX³ 63H

Rated current 108 A

4174 72	2 devices	1470	5
4174 74	3 devices	2210	5

Enclosures for MPX³ 32H and 32MA

IP 65 enclosure to use in dusty areas as well as in presence of corrosive gas or liquid

4174 80	Yellow/red with rotary handle	1700	5
4174 81	With black rotary handle	2210	5

Alpx³

SELF-HEALING
ENERGY EFFICIENT
CAPACITORS



KEY FEATURES

ROBUST PERFORMANCE EVEN STANDARD DUTY CAN BE USED IN 10% THDI

- Better heat dissipation
- Ease of installation
- Premium quality
- Compact design
- Low energy loss
- Built-in terminal connectors
- Self-healing technology for longer life

APPLICATION BENEFITS



REDUCE
ELECTRICITY
BILLS



INCREASE
SYSTEM
CAPACITY



IMPROVE
VOLTAGE



REDUCE
OVERALL SYSTEM
LOSSES



Scan to know more about
the product.

Alpx³ resin filled capacitors

Cat.Nos	Description	MRP* ₹ / Unit	Pack
---------	-------------	---------------------	------

Alpx³

Confirms to IS13340-1&2 , IEC60831-1&2
ISI Mark
Compact Design
Self healing metallized polypropylene film
Over pressure device for disconnection
Low energy losses
Resistance to high temperature
Resin filled

Can be used in system with <= 10% THDi

Standard duty can-type 440 V

5150 00	1 kVAr Resin std duty 440 V	322	1
5150 01	2 kVAr Resin std duty 440 V	678	1
5150 02	3 kVAr Resin std duty 440 V	972	1
5150 03	4 kVAr Resin std duty 440 V	1358	1
5150 04	5 kVAr Resin std duty 440 V	1594	1
5150 05	7.5 kVAr Resin std duty 440 V	2344	1
5150 06	10 kVAr Resin std duty 440 V	3130	1
5150 07	12.5 kVAr Resin std duty 440	3910	1
5150 08	15 kVAr Resin std duty 440 V	4690	1
5150 09	20 kVAr Resin std duty 440 V	6140	1
5150 10	25 kVAr Resin std duty 440 V	7750	1
5150 11	30 kVAr Resin std duty 440 V	9336	1

Standard duty can-type 480 V

5150 24	4.2 kVAr Resin 480 V	2400	1
5150 25	6.9 kVAr Resin 480 V	3864	1
5150 26	8.7 kVAr Resin 480 V	4898	1
5150 27	10.4 kVAr Resin 480 V	5888	1
5150 28	14 kVAr Resin 480 V	7842	1
5150 29	17.4 kVAr Resin 480 V	9280	1
5150 30	20.8 kVAr Resin 480 V	11034	1

Standard duty can-type 525 V

5150 31	5 kVAr Resin 525 V	2850	1
5150 32	8.3 kVAr Resin 525 V	4892	1
5150 33	10.4 kVAr Resin 525 V	5894	1
5150 34	12.5 kVAr Resin 525 V	7240	1
5150 35	16.7 kVAr Resin 525 V	9142	1
5150 36	20.8 kVAr Resin 525 V	11694	1
5150 37	25 kVAr Resin 525 V	13684	1

* MRP - Maximum Retail Price Inclusive of all taxes including GST.
Red Cat.Nos - new products

Alpx³ resin filled capacitors

Cat.Nos	Description	MRP* ₹ / Unit	Pack
---------	-------------	---------------------	------

Standard duty box-type 440 V

5150 40	1 kVAr Std box Capacitor 440 V	438	1
5150 41	2 kVAr Std box Capacitor 440 V	874	1
5150 42	3 kVAr Std box Capacitor 440 V	1312	1
5150 43	4 kVAr Std box Capacitor 440 V	1754	1
5150 44	5 kVAr Std box Capacitor 440 V	2156	1
5150 45	7.5 kVAr Std box Capacitor 440 V	3180	1
5150 46	8.33 kVAr Std box Capacitor 440 V	3582	1
5150 47	10 kVAr Std box Capacitor 440 V	4236	1
5150 48	12.5 kVAr Std box Capacitor 440 V	5298	1
5150 49	15 kVAr Std box Capacitor 440 V	6356	1
5150 50	20 kVAr Std box Capacitor 440 V	8316	1
5150 51	25 kVAr Std box Capacitor 440 V	10394	1
5150 52	50 kVAr Std box Capacitor 440 V	21580	1

Can be used in system with <= 15% THDi

Heavy duty can-type 440 V

5150 12	1 kVAr Resin heavy duty 440 V	618	1
5150 13	2 kVAr Resin heavy duty 440 V	1294	1
5150 14	3 kVAr Resin heavy duty 440 V	1854	1
5150 15	4 kVAr Resin heavy duty 440 V	2574	1
5150 16	5 kVAr Resin heavy duty 440 V	2780	1
5150 17	7.5 kVAr Resin heavy duty 440	4172	1
5150 18	10 kVAr Resin heavy duty 440	5458	1
5150 19	12.5 kVAr Resin heavy duty 44	6826	1
5150 20	15 kVAr Resin heavy duty 440	8194	1
5150 21	20 kVAr Resin heavy duty 440	10516	1
5150 22	25 kVAr Resin heavy duty 440	13148	1
5150 23	30 kVAr Resin heavy duty 440	15846	1

Heavy duty box-type 440 V

5150 53	5 kVAr HD box 440 V	3408	1
5150 54	7.5 kVAr HD box 440 V	4974	1
5150 55	8.33 kVAr HD box 440 V	5508	1
5150 56	10 kVAr HD box 440 V	6628	1
5150 57	12.5 kVAr HD box 440 V	8290	1
5150 58	15 kVAr HD box 440 V	9948	1
5150 59	20 kVAr HD box 440 V	12622	1
5150 60	25 kVAr HD box 440 V	15784	1
5150 61	50 kVAr HD box 440 V	31562	1

Bold Cat.Nos are products normally available with Legrand (India) Stockists.
Cat.Nos that are not bold - delivery within 4 - 8 weeks from the date of order.
Bold packing quantity is our mandatory packing. Orders to be placed by Legrand (India) Stockist in multiples of the same.



5150 04



5150 06



5150 47



5150 23

Reactors

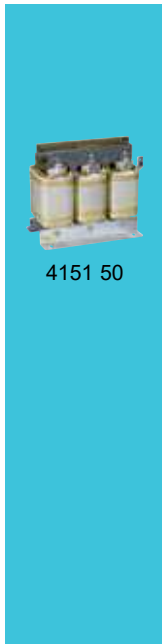

Cat.Nos	Description	MRP* ₹ / Unit	Pack
---------	-------------	------------------	------

Reactors 7 % duty

4151 48	Reactor 10 kVAr	17704	1
4151 49	Reactor 12.5 kVAr	23182	1
4151 50	Reactor 25 kVAr	29514	1
4151 51	Reactor 50 kVAr	48006	1
4151 52	Reactor 100 kVAr	96150	1

Reactors 14 % duty

4151 53	Reactor 12.5 kVAr	31284	1
4151 54	Reactor 25 kVAr	52142	1
4151 55	Reactor 50 kVAr	68938	1

Power factor controller Eco

4151 95	4 step controller	20840	1
4151 96	6 step controller	18898	1
4151 97	8 step controller	21198	1
4151 98	12 step controller	25198	1

* MRP - Maximum Retail Price Inclusive of all taxes including GST.
Red Cat.Nos - new products

Warranty

- The Company, at its discretion, will replace products if they have any manufacturing defect within 1 years for capacitor, Reactor & APFC controller.
- The above guarantee is applicable when the products are selected taken into consideration all the technical characteristics of the product published in our catalogue.
- The guarantee is only applicable when the products are installed as per the Company's instructions and not tampered in any manner.
- The guarantee states the Company's entire liability. It does not extend to cover consequential loss or damage or installation costs arising from defective products.

Alpx3 range of capacitor - Selection Chart

DETERMINING THE CAPACITOR BANK TYPE ACCORDING TO THE LEVEL OF HARMONICS

For supplies with a high level of harmonic pollution, Legrand recommends capacitor banks with detuned reactors.

The detuned reactor performs a threefold role:



- Increasing the capacitor impedance in relation to the harmonic currents
- Shifting the parallel resonance frequency (Fr.p) of the source and capacitor to below the main

frequencies of the harmonic currents that are causing interference.

Tuning frequency (Hz)	Blocking factor (P%)	Tuning number (n)
189	7	3.78
135	14	2.7

- Helping to reduce harmonic levels in the supply.

The table opposite can be used to select the capacitor bank type according to the degree of harmonic pollution, by measuring the percentage of THDi and THDu or by estimating the percentage total power of SH/ST non-linear loads.

Measurements		Estimates	Type of capacitor to be used	Reactor to be used
THDu %	THDi %	SH/ST %		
≤ 3	≤ 10	≤ 15	Standard Duty	-
≤ 4	≤ 15	≤ 25	Heavy Duty	-
≤ 6	≤ 30	≤ 35	Standard Duty	7% Reactor *14% Reactor if high level of 3rd order harmonics
≤ 8	≤ 40	≤ 50	Heavy Duty	7% Reactor

SH (kVA) is the weighted total power of the harmonic generators present at the transformer secondary.

ST (kVA) is the power rating of the HV/LV transformer.

THDi = Total Harmonic Distortion (THD) is the ratio of the rms value of the harmonic currents I_n of the order n to the rms value of the fundamental.

THDu = Voltage Distortion (THDu) is caused mainly by the high level of Current Distortion (THDi) and the level of THDu is dependent on the source impedance.

* for example if -

- $I_{h5} > 0.2 \times I_{45}$
- I_{h3} : 3rd order harmonic currents
- I_{h5} : 5th order harmonic currents

Note: These statements are based on our knowledge of typical application. We clearly point out that these statements cannot be regarded as binding statements about the suitability of our products for a particular customer application. It is necessary that the customer should check and decide whether the product is suitable for use in a particular application.

SURGE PROTECTIVE DEVICES

SOLUTIONS FOR ALL INSTALLATIONS AND RISK LEVELS



Clear, easily identifiable marking for easier maintenance, design in line with other Legrand modular equipment, well thought features: the new SPDs integrate perfectly in the modular rows of Legrand distribution boards and protects sensitive equipment.

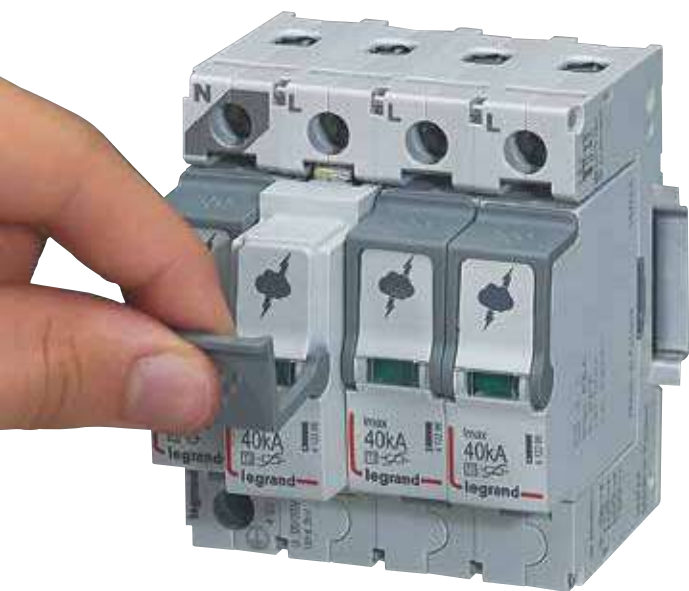

Easier to handle: the plug-in modules are easy to replace thanks to the extraction handles.

Status indicator and remote monitoring of information

Design and marking

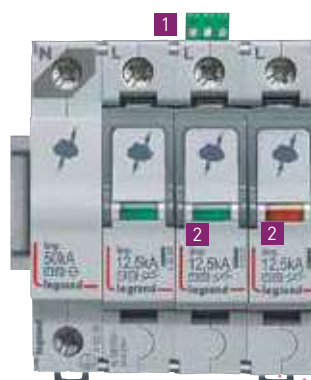

- 1 Fault signal contact
- 2 Status indicator

- 3 Dedicated marking for easier identification and maintenance of the SPDs.



Scan to know more about the product.

DX³

PERFECT CONTROL OF YOUR INSTALLATION

The DX³ range
has a selection
of electrical
auxiliaries

**for monitoring
and controlling
circuits remotely**

Auxiliary contacts and fault signal
contacts, shunt trips, undervoltage
releases, motorised controls and
automatic reclosers



Power overvoltage protection (POP)

Protects your system from serious
damages caused by Overvoltages

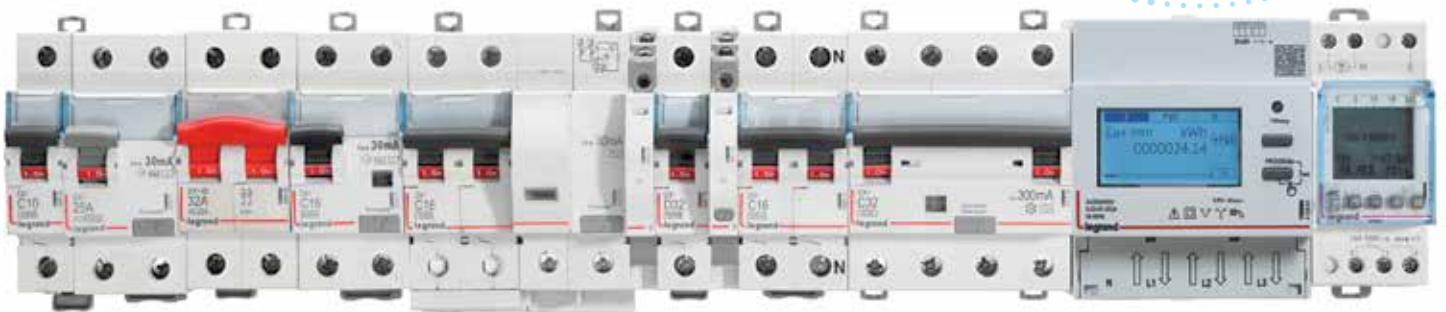

Scan to know more about
the product.

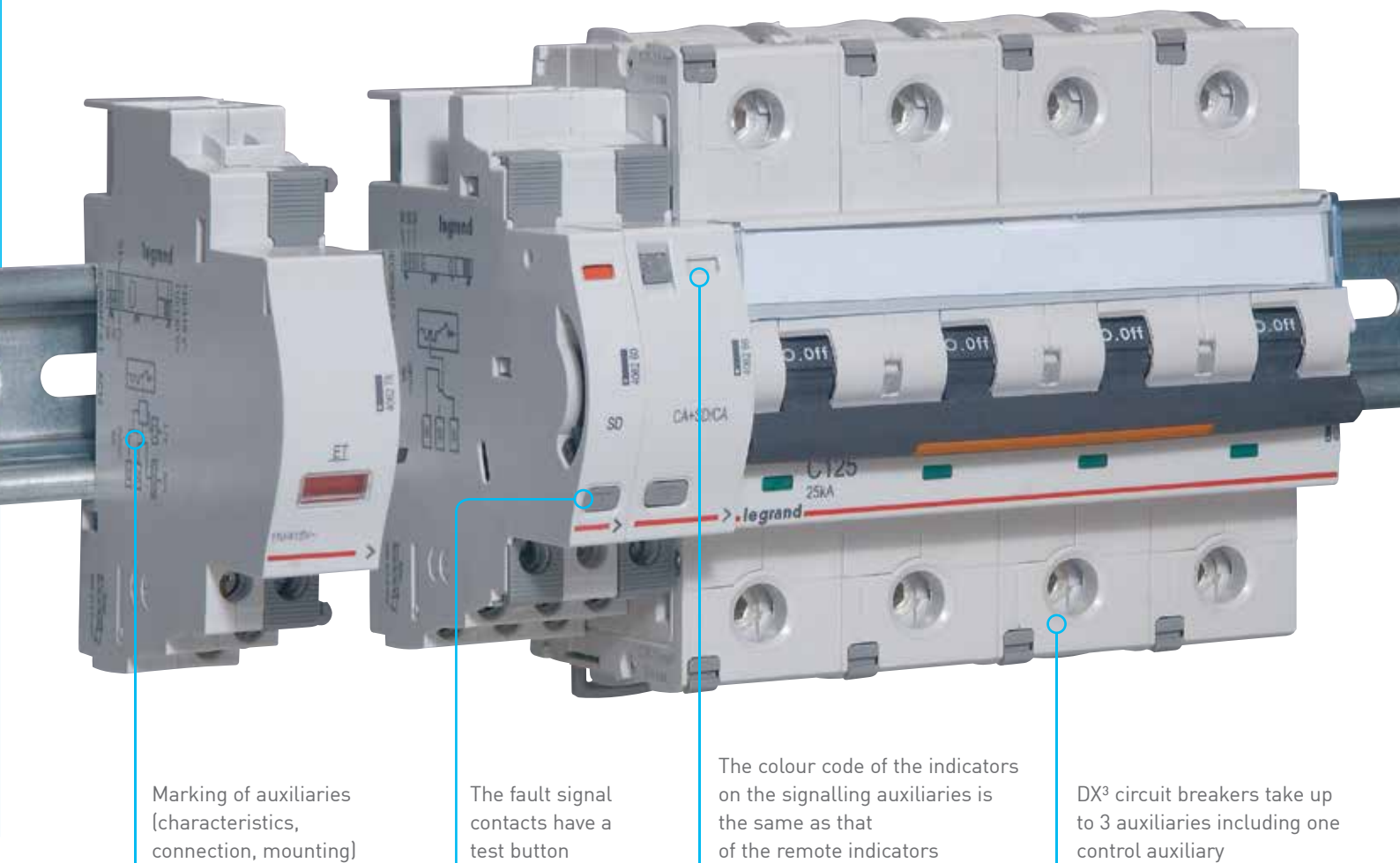

Marking of auxiliaries (characteristics, connection, mounting)

The fault signal contacts have a test button

The colour code of the indicators on the signalling auxiliaries is the same as that of the remote indicators

DX³ circuit breakers take up to 3 auxiliaries including one control auxiliary



OPTIMISED SPACE IN THE DISTRIBUTION BOARD

Legrand motorised controls are the most compact on the market: 1 module wide. They save a great deal of space inside the distribution board.

DX³ motorised controls can be used with 1 module per pole devices (circuit breakers, RCBOs and RCCBs) just as easily as auxiliaries.

DX³ AC MCBs

Cat.Nos	Nominal Rating	Number of 17.5 mm modules	MRP* ₹ / Unit	Pack
---------	----------------	---------------------------	---------------	------

MCBs for AC applications till 63A

10 kA ISI marked as per IS/IEC 60898-1 2002
 Integrated label holder
 Sliding bottom clamp
 Efficient air channels
 Color coded On/Off indication on dolly
 Biconnect lower terminals
 IP 20 protected terminals
 Sliding shutters
 Compatible with signal and control Auxiliaries

DC-80 V per pole - 1 kA

C Curve

Single pole 240/410V

4085 80	0.5	1	612	1/10/120
4085 81	1	1	612	1/10/120
4085 83	2	1	606	1/10/120
4085 84	3	1	606	1/10/120
4085 85	4	1	606	1/10/120
4085 87	6	1	376	1/10/120
4085 90	10	1	376	1/10/120
4085 92	16	1	376	1/10/120
4085 93	20	1	376	1/10/120
4085 94	25	1	376	1/10/120
4085 95	32	1	376	1/10/120
4085 96	40	1	853	1/10/120
4085 97	50	1	853	1/10/120
4085 98	63	1	853	1/10/120



4085 90

Single pole + neutral 240V

4086 02	0.5	2	1602	1/5/60
4086 03	1	2	1602	1/5/60
4086 05	2	2	1602	1/5/60
4086 06	3	2	1602	1/5/60
4086 07	4	2	1602	1/5/60
4086 09	6	2	1144	1/5/60
4086 12	10	2	1144	1/5/60
4086 14	16	2	1144	1/5/60
4086 15	20	2	1144	1/5/60
4086 16	25	2	1144	1/5/60
4086 17	32	2	1144	1/5/60
4086 18	40	2	1851	1/5/60
4086 19	50	2	1851	1/5/60
4086 20	63	2	1851	1/5/60



4086 14

Double pole 415V

4086 21	0.5	2	1664	1/40
4086 22	1	2	1664	1/40
4086 24	2	2	1664	1/40
4086 25	3	2	1664	1/40
4086 26	4	2	1664	1/40

DX³ AC MCBs

Cat.Nos	Nominal Rating	Number of 17.5 mm modules	MRP* ₹ / Unit	Pack
---------	----------------	---------------------------	---------------	------

4086 28	6	2	1225	1/40
4086 31	10	2	1225	1/40
4086 33	16	2	1225	1/40
4086 34	20	2	1225	1/40
4086 35	25	2	1225	1/40
4086 36	32	2	1225	1/40
4086 37	40	2	1928	1/40
4086 38	50	2	1928	1/40
4086 39	63	2	1928	1/40



4086 37

Triple pole 415V

4086 43	0.5	3	2427	1/32
4086 44	1	3	2427	1/32
4086 46	2	3	2427	1/32
4086 47	3	3	2427	1/32
4086 48	4	3	2427	1/32
4086 50	6	3	1968	1/32
4086 53	10	3	1968	1/32
4086 55	16	3	1968	1/32
4086 56	20	3	1968	1/32
4086 57	25	3	1968	1/32
4086 58	32	3	1968	1/32
4086 59	40	3	2985	1/32
4086 60	50	3	2985	1/32
4086 61	63	3	2985	1/32



4086 55

Triple pole + neutral 415V

4086 65	0.5	4	3078	1/32
4086 66	1	4	3078	1/32
4086 68	2	4	3078	1/32
4086 69	3	4	3078	1/32
4086 70	4	4	3078	1/32
4086 72	6	4	2565	1/32
4086 75	10	4	2565	1/32
4086 77	16	4	2565	1/32
4086 78	20	4	2565	1/32
4086 79	25	4	2565	1/32
4086 80	32	4	2565	1/32
4086 81	40	4	3669	1/32
4086 82	50	4	3669	1/32
4086 83	63	4	3669	1/32



4086 77

Four pole 415V

4086 84	0.5	4	3039	1/32
4086 85	1	4	3039	1/32
4086 87	2	4	3039	1/32
4086 88	3	4	3039	1/32

* MRP - Maximum Retail Price Inclusive of all taxes including GST.
 ♦ For further details on product contact nearest Legrand Sales Office.

Bold Cat.Nos are products normally available with Legrand (India) Stockists.
 Cat.Nos that are not bold - delivery within 4 - 8 weeks from the date of order.
 Bold packing quantity is our mandatory packing. Orders to be placed by Legrand (India) Stockist in multiples of the same.

DX³ AC MCBs



4086 94

Cat.Nos	Nominal Rating	Number of 17.5 mm modules	MRP* ₹ / Unit	Pack
4086 89	4	4	3039	1/32
4086 91	6	4	2673	1/32
4086 94	10	4	2673	1/32
4086 96	16	4	2673	1/32
4086 97	20	4	2673	1/32
4086 98	25	4	2673	1/32
4086 99	32	4	2673	1/32
4087 00	40	4	3802	1/32
4087 01	50	4	3802	1/32
4087 02	63	4	3802	1/32

D Curve

Single pole 240/415V

4087 06	0.5	1	610	1/10/120
4087 07	1	1	610	1/10/120
4087 09	2	1	610	1/10/120
4087 10	3	1	610	1/10/120
4087 11	4	1	607	1/10/120
4087 12	6	1	513	1/10/120
4087 14	10	1	513	1/10/120
4087 16	16	1	513	1/10/120
4087 17	20	1	513	1/10/120
4087 18	25	1	513	1/10/120
4087 19	32	1	513	1/10/120
4087 20	40	1	923	1/10/120
4087 21	50	1	923	1/10/120
4087 22	63	1	923	1/10/120

Single pole + neutral 240V

4087 26	0.5	2	1602	1/5/60
4087 27	1	2	1602	1/5/60
4087 29	2	2	1602	1/5/60
4087 30	3	2	1602	1/5/60
4087 31	4	2	1602	1/5/60

Double pole 415V

4087 32	0.5	2	1662	1/40
4087 33	1	2	1662	1/40
4087 35	2	2	1662	1/40
4087 36	3	2	1662	1/40
4087 37	4	2	1662	1/40
4087 38	6	2	1256	1/40
4087 40	10	2	1256	1/40
4087 42	16	2	1256	1/40
4087 43	20	2	1256	1/40
4087 44	25	2	1256	1/40
4087 45	32	2	1256	1/40
4087 46	40	2	2049	1/40



4087 46

* MRP - Maximum Retail Price Inclusive of all taxes including GST.

♦ For further details on product contact nearest Legrand Sales Office.

D Curve



4087 52

Cat.Nos	Nominal Rating	Number of 17.5 mm modules	MRP* ₹ / Unit	Pack
4087 47	50	2	2049	1/40
4087 48	63	2	2049	1/40

Triple pole 415V

4087 52	0.5	3	2475	1/32
4087 53	1	3	2475	1/32
4087 55	2	3	2475	1/32
4087 56	3	3	2475	1/32
4087 57	4	3	2475	1/32
4087 58	6	3	2028	1/32
4087 60	10	3	2028	1/32
4087 62	16	3	2028	1/32
4087 63	20	3	2028	1/32
4087 64	25	3	2028	1/32
4087 65	32	3	2028	1/32
4087 66	40	3	3132	1/32
4087 67	50	3	3132	1/32
4087 68	63	3	3132	1/32

Triple pole + neutral 415V

4087 72	0.5	4	3018	1/32
4087 73	1	4	3018	1/32
4087 75	2	4	3018	1/32
4087 76	3	4	3018	1/32
4087 77	4	4	3018	1/32

Four pole 415V

4087 78	0.5	4	3010	1/32
4087 79	1	4	3010	1/32
4087 81	2	4	3010	1/32
4087 82	3	4	3010	1/32
4087 83	4	4	3010	1/32
4087 84	6	4	2654	1/32
4087 86	10	4	2654	1/32
4087 88	16	4	2654	1/32
4087 89	20	4	2654	1/32
4087 90	25	4	2654	1/32
4087 91	32	4	2654	1/32
4087 92	40	4	4010	1/32
4087 93	50	4	4010	1/32
4087 94	63	4	4010	1/32



4087 90

Circuit breakers AC applications 80 - 125A

10 kA as per IEC 60947-2

Integrated label holder

Sliding insulating shield

Color coded contact indication window

IP 20 protected terminals

50 sq mm terminals

*Single pole 230V / 400V

4085 99	80	1.5	3310	1/5/160
---------	----	-----	------	---------

Bold Cat.Nos are products normally available with Legrand (India) Stockists. Cat.Nos that are not bold - delivery within 4 - 8 weeks from the date of order. Bold packing quantity is our mandatory packing. Orders to be placed by Legrand (India) Stockist in multiples of the same.

DX³ MCB



4086 00

Cat.Nos	Nominal Rating	Number of 17.5 mm modules	MRP* ₹ / Unit	Pack
4086 00	100	1.5	3621	1/5/161
4086 01	125	1.5	3929	1/5/162



4086 40

Double pole 230V / 400V*

4086 40	80	3	7334	1/5/60
4086 41	100	3	7817	1/5/60
4086 42	125	3	8511	1/5/60



4086 63

Triple pole 400V*

4086 62	80	4.5	11673	1/9
4086 63	100	4.5	12434	1/9
4086 64	125	4.5	13666	1/9



4087 05

Four pole 400V*

4087 03	80	6	15199	1/9
4087 04	100	6	15835	1/9
4087 05	125	6	17740	1/9

DX³ DC MCBs

Circuit breakers DC applications upto 63A

6 kA as per IEC 60947-2
Integrated label holder
Sliding bottom clamp
Improved air channels
Color coded On/Off indication on dolly
Biconnect lower terminals
IP 20 protected terminals
Sliding shutters

Single pole 250V

4087 98	0.5	1	911	1/10/120
4087 99	1	1	911	1/10/120
4088 01	2	1	902	1/10/120
4088 02	3	1	902	1/10/120
4088 03	4	1	902	1/10/120
4088 04	6	1	754	1/10/120
4088 06	10	1	754	1/10/120
4088 08	16	1	754	1/10/120
4088 09	20	1	754	1/10/120
4088 10	25	1	754	1/10/120
4088 11	32	1	762	1/10/120
4088 12	40	1	996	1/10/120
4088 13	50	1	1006	1/10/120
4088 14	63	1	1006	1/10/120



4088 12

Double pole 250V

4088 15	0.5	1	1901	1/5/60
4088 16	1	1	1901	1/5/60
4088 18	2	1	1901	1/5/60
4088 19	3	1	1901	1/5/60
4088 20	4	1	1901	1/5/60
4088 21	6	1	1762	1/5/60

* MRP - Maximum Retail Price Inclusive of all taxes including GST.
♦ For further details on product contact nearest Legrand Sales Office.

DX³ MCB

Cat.Nos	Nominal Rating	Number of 17.5 mm modules	MRP* ₹ / Unit	Pack
4088 23	10	1	1762	1/5/60
4088 25	16	1	1762	1/5/60
4088 26	20	1	1762	1/5/60
4088 27	25	1	1762	1/5/60
4088 28	32	1	1762	1/5/60
4088 29	40	1	2078	1/5/60
4088 30	50	1	2078	1/5/60
4088 31	63	1	2078	1/5/60

DX³ RDSO DC MCB

Single pole

4088 32	0.5	1	934	1/10/120
4088 33	1	1	934	1/10/120
4088 34	1.5	1	934	1/10/120
4088 35	1.6	1	934	1/10/120
4088 36	2.5	1	934	1/10/120
4088 37	3	1	683	1/10/120
4088 38	4	1	683	1/10/120
4088 39	5	1	830	1/10/120
4088 40	10	1	830	1/10/120
4088 41	15	1	830	1/10/120
4088 42	20	1	830	1/10/120
4088 43	25	1	830	1/10/120
4088 44	30	1	948	1/10/120
4088 45	35	1	948	1/10/120
4088 46	40	1	1054	1/10/120
4088 47	50	1	1054	1/10/120
4088 48	60	1	1054	1/10/120

DX³ isolators

Isolators for AC applications upto 125A

ISI marked as per IEC 60947-3
Integrated label holder
Ergonomic red color dolly
Sliding bottom clamp
Double break mechanism
Improved air channels
Color coded On/Off indication on dolly
Biconnect lower terminals
IP 20 protected terminals
Compatible with signal and control Auxiliaries
Sliding shutters

Double pole 240V

4065 00	32	2	648	1/5/60
4065 01	40	2	714	1/5/60
4065 02	63	2	944	1/5/60
4065 04	100	2	1296	1/5/60
4065 05	125	2	1474	1/5/60



4065 00

Triple pole 415V

4065 09	32	3	1170	1/40
4065 10	40	3	1254	1/40
4065 11	63	3	1492	1/40



4065 10

Bold Cat.Nos are products normally available with Legrand (India) Stockists. Cat.Nos that are not bold - delivery within 4 - 8 weeks from the date of order. Bold packing quantity is our mandatory packing. Orders to be placed by Legrand (India) Stockist in multiples of the same.

Isolators for AC applications upto 125A

Cat.Nos	Nominal Rating	Number of 17.5 mm modules	MRP* ₹ / Unit	Pack
4065 13	100	3	1648	1/40
4065 14	125	3	1900	1/40

Four pole 415V

4065 18	32	4	1283	1/32
4065 19	40	4	1592	1/32
4065 20	63	4	1757	1/32
4065 22	100	4	2122	1/32
4065 23	125	4	2339	1/32



4065 20

DX³ RCCBs

RCCBs for AC applications upto 63A

ISI marked as per IS 12640-1

Integrated label holder

Ergonomic Grey color dolly

Sliding bottom clamp

Compatible with signal and control Auxiliaries

Color coded On/Off indication on dolly

Biconnect lower terminals

IP 20 protected terminals

35 sq mm terminals

Sliding shutters

Type - AC

Sensitive to residual alternating currents

Use : standard applications

Double pole 240V

30 mA

4118 51	25	2	3758	1/5/60
4118 52	40	2	4364	1/5/60
4118 53	63	2	5364	1/5/60



4118 57

100 mA

4118 56	25	2	4140	1/5/60
4118 57	40	2	4782	1/5/60
4118 58	63	2	5694	1/5/60

300 mA

4118 61	25	2	4212	1/5/60
4118 62	40	2	4872	1/5/60
4118 63	63	2	5716	1/5/60

Four pole 415V

30 mA

4118 76	25	4	5154	1/32
4118 77	40	4	5282	1/32
4118 78	63	4	5876	1/32



4118 77

100 mA

4118 81	25	4	5434	1/32
4118 82	40	4	5498	1/32
4118 83	63	4	6466	1/32



4118 83

300 mA

4118 86	25	4	5596	1/32
4118 87	40	4	5678	1/32
4118 88	63	4	6488	1/32

RCCBs for AC applications upto 63A

Cat.Nos	Nominal Rating	Number of 17.5 mm modules	MRP* ₹ / Unit	Pack
---------	----------------	---------------------------	---------------	------

Type - S

Delayed trip for discrimination with other residual current devices.

Use : for discrimination with a downstream device

Double pole 415V, A-S

300 mA

4118 66	25	2	7236	1/5/60
4118 67	40	2	7596	1/5/60
4118 68	63	2	7816	1/5/60

Four pole 415 V, A-S

300 mA

4118 91	25	4	8148	1/5/60
4118 92	40	4	8252	1/5/60
4118 93	63	4	8622	1/5/60



4118 93

Type Hpi

Enhanced immunity to unwanted tripping in environments with disturbances. eg. diesels, computers, printers, etc.

• Detects faults with DC components eg. thyristors, trio etc.

Double pole 240V HPI

30 mA

4118 71	25	2	7912	1/5/60
4118 72	40	2	8306	1/5/60
4118 73	63	2	8548	1/5/60

Four pole 415V HPI

30 mA

4118 96	25	4	8962	1/32
4118 97	40	4	9244	1/32
4118 98	63	4	9484	1/32



4118 97

DX³ RCBOs

RCBOs assembled for AC applications upto 63A

ISI marked as per IS 12640-2

Integrated label holder

Ergonomic design

Color coded On/Off indication on dolly

Compatible with signal and control Auxiliaries

Front face indication for earth leakage fault

IP 20 protected terminals

35 sq mm terminals

Sliding shutters

Type - AC

Sensitive to residual alternating currents

Use : standard applications

Double pole 240V AC Type

30 mA

4113 22	6	4	4682	1/32
4113 23	10	4	4682	1/32
4113 24	16	4	4734	1/32
4113 25	25	4	4734	1/32
4113 26	32	4	4942	1/32
4113 27	40	4	5674	1/32
4113 28	63	4	6914	1/32



4113 24

* MRP - Maximum Retail Price Inclusive of all taxes including GST.

Bold Cat.Nos are products normally available with Legrand (India) Stockists. Cat.Nos that are not bold - delivery within 4 - 8 weeks from the date of order. Bold packing quantity is our mandatory packing. Orders to be placed by Legrand (India) Stockist in multiples of the same.

RCBOs assembled for AC applications upto 63A

Cat.Nos	Nominal Rating	Number of 17.5 mm modules	MRP* ₹ / Unit	Pack
---------	----------------	---------------------------	---------------	------

100 mA

4113 29	6	4	5834	1/32
4113 30	10	4	5834	1/32
4113 31	16	4	5642	1/32
4113 32	25	4	5642	1/32
4113 33	32	4	5642	1/32
4113 34	40	4	6442	1/32
4113 35	63	4	7434	1/32

300 mA

4113 36	16	4	5862	1/32
4113 37	25	4	5862	1/32
4113 38	32	4	5862	1/32
4113 39	40	4	6610	1/32
4113 40	63	4	7446	1/32

Four pole 415V, AC type 30 mA

4113 65	16	7	6324	1/16
4113 66	25	7	6324	1/16
4113 67	32	7	6522	1/16
4113 68	40	7	6638	1/16
4113 69	63	7	7614	1/16

Four pole 415V, AC type 100 mA

4113 70	16	7	7128	1/16
4113 71	25	7	7128	1/16
4113 72	32	7	7196	1/16
4113 73	40	7	7330	1/16
4113 74	63	7	8068	1/16

Four pole 415V, AC type 300 mA

4113 75	16	7	7350	1/16
4113 76	25	7	7350	1/16
4113 77	32	7	7476	1/16
4113 78	40	7	7626	1/16
4113 79	63	7	8210	1/16



4113 79

RCBOs compact for AC applications upto 32A, 6kA

Conforms to IEC 60947
Integrated label holder
Ergonomic design

Color coded On/Off indication on dolly
Front face indication for earth leakage fault
IP 20 protected terminals
35 sq mm terminals
Sliding shutters

* MRP - Maximum Retail Price Inclusive of all taxes including GST.

RCBOs compact for AC applications

Cat.Nos	Description	Number of 17.5 mm modules	MRP* ₹ / Unit	Pack
---------	-------------	---------------------------	---------------	------

Type- AC

Sensitive to residual alternating currents

Use : standard applications

Double pole 240V, AC type

30 mA

4113 90	6	2	5566	1/32
4113 91	10	2	5566	1/32
4113 92	16	2	5566	1/32
4113 93	20	2	5566	1/32
4113 94	25	2	5566	1/32
4113 95	32	2	5842	1/32



4113 94

300 mA

4113 97	6	2	5734	1/32
4113 98	10	2	5836	1/32
4113 99	16	2	5836	1/32
4114 00	20	2	5836	1/32
4114 01	25	2	5836	1/32
4114 02	32	2	6126	1/32

Four pole 415V, AC type 30 mA

4114 18	10	4	7606	1/16
4114 19	16	4	7606	1/16
4114 20	20	4	7606	1/16
4114 21	25	4	7606	1/16

Four pole 415V, AC type 300 mA

4114 23	10	4	8738	1/16
4114 24	16	4	8738	1/16
4114 25	20	4	8738	1/16
4114 26	25	4	8738	1/16

Type Hpi

Enhanced immunity to unwanted tripping in environments with disturbances. eg. diesels, computers, printers, etc.

• Detects faults with DC components eg. thyristors, trio etc.

Double pole 240V, HPI type

30 mA

4114 15	25	2	10610	1/32
4114 16	32	2	11216	1/32
4114 17	40	2	13342	1/32

Type A

Sensitive to residual alternating currents and residual currents with a DC component.

Use : special applications

- if it is possible that the fault currents are not purely sinusoidal (rectifier bridge, etc.)

Four pole 415V, A type

30 mA

4114 28	10	4	8578	1/16
4114 29	16	4	8578	1/16
4114 30	20	4	8578	1/16
4114 31	25	4	8578	1/16

Bold Cat.Nos are products normally available with Legrand (India) Stockists. Cat.Nos that are not bold - delivery within 4 - 8 weeks from the date of order. Bold packing quantity is our mandatory packing. Orders to be placed by Legrand (India) Stockist in multiples of the same.

RCBOs compact for AC applications

Cat.Nos	Nominal Rating	Number of 17.5 mm modules	MRP* ₹ / Unit	Pack
---------	----------------	---------------------------	---------------	------

Four pole 415V, A type 300 mA

4114 33	10	4	9670	1/16
4114 34	16	4	9670	1/16
4114 35	20	4	9670	1/16
4114 36	25	4	9670	1/16

DX³ RCD add on module

For 125A

Conform to IEC 61009-1

AC type : detect AC components faults

Hpi type :detect faults with AC and DC components, increased

Immunity to false tripping

For mounting on the right-hand side of 1.5 module per pole DX³ MCBs

Easy & fast association mechanism

Terminal cover for locking

70 sq mm terminals

Double pole 240V, AC type

30 mA

4105 68	125 A	4	17294	1
---------	-------	---	-------	---

100 mA

4105 69	125 A	4	19500	1
---------	-------	---	-------	---

300 mA

4105 71	125 A	4	19500	1
---------	-------	---	-------	---

Four pole 415V, AC type

30 mA

4106 25	125 A	4	26724	1
---------	-------	---	-------	---

100 mA

4106 26	125 A	4	29862	1
---------	-------	---	-------	---

300 mA

4106 29	125 A	4	29862	1
---------	-------	---	-------	---

Double pole 240V, HPI type

30 mA

4105 78	125 A	6	21602	1
---------	-------	---	-------	---

100 mA

4105 79	125 A	6	24146	1
---------	-------	---	-------	---

300 mA

4105 82	125 A	6	24146	1
---------	-------	---	-------	---

Four pole 415V, HPI type

30 mA

4106 38	125 A	6	37030	1
---------	-------	---	-------	---

100 mA

4106 39	125 A	6	39098	1
---------	-------	---	-------	---

300 mA

4106 42	125 A	6	39098	1
---------	-------	---	-------	---

* MRP - Maximum Retail Price Inclusive of all taxes including GST.



4105 68



4105 78



4062 50



4062 52



4062 78



4062 82

DX³ auxiliaries

Cat.Nos	Description	Number of 17.5 mm modules	MRP* ₹ / Unit	Pack
---------	-------------	---------------------------	---------------	------

Auxiliaries common for MCBs, isolators, RCCBs & RCBOs

Easy & fast fixation on site

On site clip on mounting

Clip on fitting on left side

Signalling auxiliaries

4062 50	Auxiliary changeover switch 6 A	0.5	1228	1
4062 52	Fault signalling changeover switch 6 A	0.5	1432	1
4062 64	Changeover + fault signalling switch	1	2267	1

Control auxiliaries

4062 76	Shunt release 12 /48 V AC/ DC	1	3155	1
4062 78	Shunt release 110/415 V V AC	1	3155	1
4062 80	Undervoltage release 24/48 V AC/DC	1	2687	1
4062 82	Undervoltage release 230 V AC	1	2687	1

Control auxiliaries

4062 86	Pop over voltage release	1	3424	1
4062 90	Motor control 24/48 V AC/ DC	1	12343	1
4062 91	Motor control 110/415 V AC	1	12343	1
4062 93	Motor control 24/48 V AC/ DC	2	23238	1
4062 95	Motor control 110/415 V AC	2	21948	1
4062 88	Automatic resetter	2	16390	1
4062 89	Automatic resetter with autotest	2	20514	1

Bold Cat.Nos are products normally available with Legrand (India) Stockists. Cat.Nos that are not bold - delivery within 4 - 8 weeks from the date of order. Bold packing quantity is our mandatory packing. Orders to be placed by Legrand (India) Stockist in multiples of the same.

DX³ auxiliaries

Cat.Nos	Description	Number of 17.5 mm modules	MRP* ₹ / Unit	Pack
---------	-------------	---------------------------	---------------	------

Rotary handle

4063 19	Black rotary handle	-	2563	10
4063 20	Yellow/red rotary handle	-	2774	10

Support for padlock

4063 03	Support for padlock till 63 A	-	594	10
---------	-------------------------------	---	-----	----

Sealable screw cover

4063 04	Devices upto 63 A	-	588	10
4063 06	For 80-125 A devices	-	1025	10

1/2 module spacing unit

4063 07	1/2 module spacing unit	0.5	217	10
---------	-------------------------	-----	-----	----

5 mm padlock

4063 13	5 mm Padlock	0.5	503	10
---------	--------------	-----	-----	----

Manual changover switch

Compact design
Manual switching operation
Easy to assemble
Ergonomic design

For 1 mod/pole devices

4063 14	Manual change-over switch for DP	1	2910	5
4063 15	Manual change-over switch for TP	1	3362	5
4063 16	Manual change-over switch for FP	1	3734	5

DX³ RCD add on module

with measurement & metering

Cat.Nos	Nominal Rating	Number of 17.5 mm modules	MRP* ₹ / Unit	Pack
---------	----------------	---------------------------	---------------	------

Conform to IEC 61009-1
Hpi type: detect faults with AC and DC components, increased
Immunity to false tripping
Inbuilt measurement/metering option
Measurement - V, A, F, PF, kWh, KVA, KVAR, THD
Metering - V, A, F, kWh
RS 485 port for remote reading
Di-electric test button inbuilt
Ergonomic test button
Scroll button for easy readings
RLCD display on front facia
For mounting on the right-hand side of 1.5 module per pole DX3 MCBs

■ Price available on request.

* MRP - Maximum Retail Price Inclusive of all taxes including GST.

¹ 1P+N and 3P+N: L-N and N-PE protection modes (common and differential modes), the N pole being protected by encapsulated spark gaps. Also called sometimes 1+1 and 3+1

² Replaced mid 2015 by Cat.No 4122 80

DX³ RCD add on module

Cat.Nos	Nominal Rating	Number of 17.5 mm modules	MRP* ₹ / Unit	Pack
---------	----------------	---------------------------	---------------	------

Easy & fast association mechanism
70 sq mm terminals

Adjustable metering, four pole 415 V

4106 57	63 A	7	18952	1
4106 58	125 A	7	34006	1

Adjustable measurement

4106 59	125 A	7	37048	1
---------	-------	---	-------	---

DX³ time switches

Cat.Nos	Description	No. of Modules	MRP* ₹ / Unit	Pack
---------	-------------	----------------	---------------	------

For switching an electric circuit (lighting, heating) ON or OFF at selected times during a pre-programmed time period.

Alpharex3 Digital Time switches

Weekly time switch

Time-saving programming by selection of daily blocks, daily blocks individually adjustable or selection from preset blocks Mo-Fr and Mo-Su

Permanent ON or OFF

Circuit anticipation

Power reserve 3 years for date, time and switching program

Accuracy +/- 1 sec./Day

0037 10	Power supply 230 V~ 50/60Hz 1 NO contact 250 V/50 Hz 16 A - cos ϕ = 1 28 programmes Shortest switching-time 1 min	1	6094	1
---------	--	---	------	---

Multiple functions - daily or weekly time switch programme - 5 years clock working reserve

Programme settings: on daily or weekly basis
15 languages

A programme consists of a on and off time and their assignment to certain days

Option to suspend the programme for a specific period to set-up with start and date

Minimum programme setting: 1 s.

High precision clock: \pm 0.1 sec per day

Particularly suited to irregular cycles:

- security installations (access point, alarms, etc.),
- industrial installations (pump stations, etc.)

Programmed directly on keypad, or using program transfer key Cat.No 4 128 72

Additional functions including random (irregular cycles), hour counters

4126 31	1 output 16 A - 250 V~ - 50/60 Hz56 programmes 1 Channel	2	6910	1
4126 41	2 output 16 A - 250 V~ - 50/60Hz 2x28 programmes 2 Channel	2	9726	1



4106 57



4126 41

Bold Cat.Nos are products normally available with Legrand (India) Stockists. Cat.Nos that are not bold - delivery within 4 - 8 weeks from the date of order. Bold packing quantity is our mandatory packing. Orders to be placed by Legrand (India) Stockist in multiples of the same.

DX³ time switches

Cat.Nos	Description	No. of Modules	MRP* ₹ / Unit	Pack
---------	-------------	----------------	------------------	------

Digital time switch with astronomical function

- For switching on/off lights and other electric devices according to the rising/setting of the sun
- With combination function for creating switching programs in which the devices are switched according to astronomical time and/or fixed preset times
- Daily astronomical calculation of the sunrise/sunset times based on the entered location or location coordinates

4126 54	1 output 16 A - 250 V~ 50/60 Hz Astronomical function 56 Programmes 1 Channel	2	12344	1
4126 57	2 output 16 A - 250 V~ 50/60 Hz Astronomical function 2x28 programmes 2 Channel	2	14086	1



4126 54



4126 57

Alpharex³ yearly time switch

- Yearly and weekly time switch with additional astronomical function for all channels
- 84 switching programs per channel, comprising:
 - 28 weekly programs
 - 28 yearly programs
 - 28 special programs (priority program)

4126 30	2 outputs - 230 V~ 50/60 Hz Astronomical function 2 x 3 x 28 = 168 programmes	2	22892	1
---------	---	---	-------	---

Cat.Nos	Description	MRP* ₹ / Unit	Pack
---------	-------------	------------------	------

Programming accessories

4128 72	Programming transfer key Can be used to store programme settings made: Directly on a multifunction and multi-programme time switch Cat.Nos 4 126 30/31/32/33/41/54/57 (loading on device) -with the programming software installed on a PC running Windows (loading on data loader)	2572	1
4128 73	Programming software Kit Can be used to create, save and transfer program settings for multi-function and multi-program time switches. Data is transferred to the program transfer key using the data loader connected to the USB port of the PC. 4128 73 Kit comprising software on CD-ROM, data loader and transfer key Windows XP, Windows 7, Windows 8 compatible"	5486	1

* MRP - Maximum Retail Price Inclusive of all taxes including GST.

1P+N and 3P+N: L-N and N-PE protection modes (common and differential modes), the N pole being protected by encapsulated spark gaps. Also called sometimes 1+1 and 3+1

DX³ time switches

Cat.Nos	Description	MRP* ₹ / Unit	Pack
---------	-------------	------------------	------

Twilight switches

- Light sensitive switches
- Can be used to switch a lighting circuit "ON" and "OFF" based on light conditions (nightfall, daybreak)
- Supplied with IP 65 weatherproof photoelectric cell
- Adjustable from 1 to 100 000 lux

4126 23	Luxo Switch / Light sensitive switch with Lux Sensor - Output 16 A 250 V~	8744	1
---------	---	------	---

MicroRex analog time switches

- Programmed via captive segment
- Power supply: 230 V~ 50/60 Hz
- 3-position override switch "ON-AUTO-OFF" on front panel
- Manual changeover to summer/winter time
- 1 outlet 16 A - 250 V~ - $\mu \cos = 1$
- Analogue time switch daily programme**
- 1 segment = 15 minutes
- Accuracy: ± 5 minutes
- 1 outlet 16 A - 250 V~ - $\mu \cos = 1$

4127 80	Vertical Dial N/O Contact - without working Reserve -Minimum switching time: 15 minutes	1	3570	1
4127 90	Vertical Dial N/O Contact - with 100 h working Reserve -Minimum switching time: 15 minutes	1	4204	1



4128 12

4128 12	Horizontal Dial Changeover Switch - without working Reserve -Minimum switching time: 15 minutes	3	5386	1
4128 13	Horizontal Dial Changeover Switch - with 100 h working Reserve -Minimum switching time: 15 minutes	3	6670	1

Analogue time switch weekly programme

- 1 segment = 2 hours
- Accuracy: ± 30 minutes
- 1 outlet 16 A - 250 V~ - $\mu \cos = 1$

4127 94	Vertical Dial N/O Contact - with 100 h working Reserve -Minimum switching time: 2 hours	1	4654	1
4127 95	Horizontal Dial Changeover Switch - with 100 h working Reserve -Minimum switching time: 4 hours	3	6740	1

DX³ contactors

Power contactors / modular contactors CX³

Conform to IEC/EN 61095

Space for power supply busbar on top (up to 25 A)

Bold Cat.Nos are products normally available with Legrand (India) Stockists. Cat.Nos that are not bold - delivery within 4 - 8 weeks from the date of order. Bold packing quantity is our mandatory packing. Orders to be placed by Legrand (India) Stockist in multiples of the same.

Power contactors / modular Contactors CX³

Cat.Nos	Description	MRP* ₹ / Unit	Pack
---------	-------------	------------------	------

Power contactors with 230 V~ coil and handle
Manual override for test and repair function, carried out via the handle
Permanent "ON" or "OFF" without automatic closing of the contactor

4125 44	25 A 2 NO contactor	2580	1
4125 45	40 A 2 NO contactor	4400	1
4125 47	63 A 2 NO contactor	5120	1
4125 48	63 A 2 NC contactor	5120	1
4125 49	40 A 3 NO contactor	7360	1
4125 50	63 A 3 NO contactor	8320	1
4125 51	25 A 4 NO contactor	3040	1
4125 53	40 A 4 NO contactor	7770	1
4125 56	63 A 4 NO contactor	9200	1
4125 57	63 A 4 NC contactor	9280	1

Signalling auxiliaries for contactors

Auxiliary changeover switch

4124 29	For 1 module contactors 16 A to 25 A	3780	1
4124 30	For 2 module contactors 25 A	3790	1

DX³ for photovoltaic applications

DC MCBs

Cat.Nos	Description	MRP* ₹ / Unit	Pack
---------	-------------	------------------	------

Breaking capacity 4.5 kA according to EN 60947-2

800 V= circuit breakers

4144 24	6 A	8636	1
4144 25	8 A	8636	1
4144 26	10 A	8636	1
4144 27	13 A	8636	1
4144 28	16 A	8636	1
4144 29	20 A	8636	1

1000 V= circuit breakers

4144 46	10 A	23142	1
4144 47	13 A	23142	1
4144 48	16 A	23142	1
4144 49	20 A	23142	1
4144 50	25 A	23142	1
4144 51	32 A	23142	1

Type 2 voltage surge protectors

DC side protection of photovoltaic installations connected to the low voltage network (without energy storage system)

Conforming to UTE guide C 61-740-51 Protection in common mode and residual current mode (Y mode) 1
Consisting of plug-in modules with LED indicator Red: modules need to be replaced

Voltage surge protectors

DX³ for photovoltaic applications Type 2 voltage surge protectors

Cat.Nos	Description	MRP* ₹ / Unit	Pack
---------	-------------	------------------	------

4141 55	600 V= 25KA I _{max}	■	1
4141 56	1000 V 40KA I _{max}	■	1

Plug-in replacement module

4141 85	+/- cassette for voltage surge protector 4141 55	■	1
4141 86	T cassette for voltage surge protector 4141 56	■	1

DC rotary handle isolating switches

Category of use DC 21B according to EN 60947-3

Double break contacts

600 V= isolating switches

4142 61	16 A	9736	1
4142 62	25 A	10998	1
4142 63	32 A	10998	1

1000 V= isolating switches

4142 81	16 A	18854	1
4142 82	25 A	18812	1
4142 83	32 A	19552	1

Accessories

4063 05	Pole separation divider	161	1
4063 07	Spacing unit 0.5 unit	217	10

Class I (T1) low voltage SPDs

Cat.Nos	Number of poles	Neutral position	I _{total} (10/350)	Remote monitoring (contact) (MS)	Number of modules	MRP* ₹ / Unit
---------	-----------------	------------------	-----------------------------	----------------------------------	-------------------	------------------

SPDs for general protection of main distribution-board

T1+T2 - limp 12,5 kA/pole T2 - 60 kA

4122 70	1P	-	12.5 kA	No	1	9374
4122 76 ¹	1P+N	Right	25 kA	Yes	2	16494
4122 71	2P	-	25 kA	No	2	18102
4122 72	3P	-	37.5 kA	Yes	3	22442
4122 77 ¹	3P+N	Right	50 kA	Yes	4	30072
4122 73	4P	-	50 kA	No	4	27528

T1+T2 - limp 8 kA/pole T2 - 60 kA

4122 50	1P	-	8 kA	No	1	7832
4122 56 ¹	1P+N	Right	16 kA	No	2	14244
4122 51	2P	-	16 kA	No	2	15130
4122 52	3P	-	25 kA	No	3	21318
4122 57 ¹	3P+N	Right	25 kA	No	4	25910
4122 53	4P	-	32 kA	No	4	27460



4122 57

* MRP - Maximum Retail Price Inclusive of all taxes including GST.

¹ 1P+N and 3P+N: L-N and N-PE protection modes (common and differential modes), the N pole being protected by encapsulated spark gaps. Also called sometimes 1+1 and 3+1

² Replaced mid 2015 by Cat.No 4122 80

Bold Cat.Nos are products normally available with Legrand (India) Stockists. Cat.Nos that are not bold - delivery within 4 - 8 weeks from the date of order. Bold packing quantity is our mandatory packing. Orders to be placed by Legrand (India) Stockist in multiples of the same.

Class I (T1) low voltage SPDs

Cat.Nos	Number of poles	Neutral position	Total (10/350)	Remote status monitoring (FS contact)	Number of modules	MRP* ₹ / Unit
---------	-----------------	------------------	----------------	---------------------------------------	-------------------	---------------

SPDs for high risk level installations

T1 - limp 50 kA/pole - 440 V~ (IT) - Monobloc

0030 00	1P	-	50 kA	No	2	9126
---------	----	---	-------	----	---	------

T1 - limp 35 kA/pole - 440 V± (IT) - Plug-in

4122 80	1P	-	35 kA	Yes	2	20748
---------	----	---	-------	-----	---	-------

T1 - limp 25 kA/pole

4122 81 ¹	1P+N	Right	50 kA	Yes	4	26958
4122 82	3P	-	75 kA	Yes	6	64450
4122 83 ¹	3P+N	Right	100 kA	Yes	8	73976



4122 83

4123 03



4122 84

Replacement plug-in modules

Cat.Nos	Description	MRP* ₹ / Unit	Pack
---------	-------------	---------------	------

4123 02	For SPDs T1+T2 - 8 kA Cat.Nos 4122 50/ 51/52/53/56/57	7436	1
4123 03	For SPDs T1+T2 - 12.5 kA Cat.Nos 4122 70/ 71/72/73/76/77	7016	1
4122 84	For SPDs T1 - 25 kA Cat.Nos 4122 81/82/83 and 0030 20/22/23/27	20192	1
4122 85	N-PE module for SPDs T1 - 25 kA Cat.Nos 4122 81/83 and 0030 23	27402	1
4122 86	For SPDs T1 - 35 kA Cat.No 4122 80	6772	1

Cabling accessories

4123 10	Ready to use cabling kit consisting of 5 conductors (including the earth conductor) Cross section :16 mm ² Length : 40 cm For cabling SPDs in industrial enclosures (for EN/IEC 61439 compliance).	1450	1
---------	--	------	---

Class II (T2) low voltage SPDs

Cat.Nos	Number of poles	Neutral position	Remote status monitoring (FS contact)	Number of modules	MRP* ₹ / Unit	Pack
---------	-----------------	------------------	---------------------------------------	-------------------	---------------	------

T2 SPDs

T2 - I_{max} 40 kA/pole

4122 40	1P	-	No	1	5658	1
4122 46 ¹	1P+N	Right	No	2	10776	1
4122 41	2P	-	No	2	10776	1
4122 42	3P	-	Yes	3	15782	1
4122 47 ¹	3P+N	Right	No	4	19206	1
4122 43	4P	-	No	4	19206	1



4122 43

■ Price available on request.

* MRP - Maximum Retail Price Inclusive of all taxes including GST.

¹ 1P+N and 3P+N: L-N and N-PE protection modes (common and differential modes), the N pole being protected by encapsulated spark gaps. Also called sometimes 1+1 and 3+1

² Replaced mid 2015 by Cat.No 4122 80

Class II (T2) low voltage SPDs

Cat.Nos	Number of poles	Neutral position	Remote status monitoring (FS contact)	Number of modules	MRP* ₹ / Unit	Pack
---------	-----------------	------------------	---------------------------------------	-------------------	---------------	------

T2 - I_{max} 40 kA/pole - 440 V~ (IT)

4122 30	1P	-	No	1	7494	1
4122 32	3P	-	Yes	3	22442	1
4122 33	4P	-	Yes	4	27528	1

T2 - I_{max} 20 kA/pole

4122 20	1P	-	No	1	4394	1
4122 26 ¹	1P+N	Right	No	2	8430	1
4122 21	2P	-	No	2	8430	1
4122 27 ¹	3P+N	Right	No	4	15694	1
4122 23	4P	-	No	4	15694	1

Replacement plug-in modules

Cat.Nos	Description	MRP* ₹ / Unit	Pack
---------	-------------	---------------	------

4122 99	For SPDs T2 - 40 kA Cat.Nos 4122 40/ 41/42/43/44/45/ 46/47/66/67	4786	1
4123 00	N-PE module for SPDs T2 - 40 kA Cat.Nos 4122 46/47	9580	1
4123 01	For SPDs T2 - 440 V Cat.Nos 4122 30/32/33	7366	1
4122 97	For SPDs T2 - 20 kA Cat.Nos 4122 20/ 21/23/26/27/62/63	3618	1
4123 98	N-PE module for SPDs T2 - 20 kA Cat.Nos 4122 24/25/26/27	7860	1



4122 99

Class II (T2) low voltage SPDs with integrated protection

Cat.Nos	Number of poles	Neutral position	Integrated protection	Number of modules	MRP* ₹ / Unit	Pack
---------	-----------------	------------------	-----------------------	-------------------	---------------	------

Protection for consumer units

T2 self protected SPDs - I_{max} 12 kA/pole

0039 51 ¹	1P+N	Left	I _{sc} ≤ 6 kA	2	10984	1
0039 53 ¹	3P+N	Left	I _{sc} ≤ 6 kA	6	23960	1



0039 51



0039 53

Protection for secondary distribution boards

T2 self protected SPDs - I_{max} 12 kA/pole

0039 71 ¹	1P+N	Left	I _{sc} ≤ 10 kA	2	10984	1
0039 73 ¹	3P+N	Left	I _{sc} ≤ 10 kA	6	23960	1

Bold Cat.Nos are products normally available with Legrand (India) Stockists. Cat.Nos that are not bold - delivery within 4 - 8 weeks from the date of order. Bold packing quantity is our mandatory packing. Orders to be placed by Legrand (India) Stockist in multiples of the same.

ACCL

AUTOMATIC CHANGEOVER WITH CURRENT LIMITER

Seamless and uninterrupted switchover for smart spaces



→ Intelligent micro-controller based design

→ Automatic source change over between Mains & Generator supply

→ Current limitation function prevents over loading of the generator

→ Manual reset for restoring supply in sleep mode

→ Break before make change over system

→ Neutral isolation

→ Direct mount on DIN rail channel

→ Buzzer and LED light indication of status-Overload, Mains, Gen



Scan to know more about the product.

Class II (T2) low voltage SPDs with integrated protection

Cat.Nos	Description	MRP* ₹ / Unit	Pack
---------	-------------	------------------	------

Replacement plug-in modules

For self protected SPDs

0039 54	Cat.Nos 0039 51/53	7912	1
0039 74	Cat.Nos 0039 71/73	8182	1

SPDs for telephone lines

Cat.Nos	In/lmax	Max. voltage (Uc)	Level of protection (Up)	No. of modules	MRP* ₹ / Unit	Pack
---------	---------	-------------------	--------------------------	----------------	------------------	------

SPDs for telephone and data lines

"Analogue" SPD (STN, non-unbundled ADSL, etc.)

0038 28	5/10 kA	170 V	260 V	1	15018	1
---------	---------	-------	-------	---	-------	---

"Digital" SPD (unbundled ADSL, SDSL, ISDN, etc.)

0038 29	5/10 kA	48 V	100 V	1	15272	1
---------	---------	------	-------	---	-------	---

DX³ changeover switches

Cat.Nos	Description	MRP* ₹ / Unit	Pack
---------	-------------	------------------	------

Changeover switches

Single pole - two way - 250V AC

4129 00	32 A	3876	10/100
---------	------	------	--------

Double pole - two way - 400V AC

4129 01	32 A	3876	5/50
---------	------	------	------

Double pole - two way with centre off - 400V AC

4129 03	32 A	4058	5/50
---------	------	------	------

Four pole - two way with centre off - 400V AC

6040 22	40 A	6284	2/20
---------	------	------	------

* MRP - Maximum Retail Price Inclusive of all taxes including GST.

1 1P+N and 3P+N: L-N and N-PE protection modes (common and differential modes), the N pole being protected by encapsulated spark gaps. Also called sometimes 1+1 and 3+1

Automatic changeover with current limiter(ACCL)

Cat.Nos	Description	MRP* ₹ / Unit	Pack
---------	-------------	------------------	------

Automatic changeover with current limiter(ACCL)

Intelligent micro controller based design

Automatic source change over between Mains &

Generator supply

Break before make change over system

Buzzer and Led Indication of status

Current limitation prevents overloading of the generator

405300	SPN 30/3A	3012	1/15
405301	SPN 30/4A	3012	1/15
405302	SPN 30/5A	3012	1/15
405303	SPN 30/6A	3012	1/15
405304	SPN 30/9A	3012	1/15
405305	SPN 30/12A	3012	1/15
405306	SPN 30/15A	3012	1/15
405307	SPN 30/20A	3012	1/15
405308	SPN 30/30A	3012	1/15

DX³ push button

Push button cum switch

Push button cum switch - 1 module - 20A-250V AC

Single function

4129 08	Contact 1 NO	3202	10/100
4129 09	Contact 1 NC	3202	10/60
4129 10	Contact 2 NO	3202	10/60

Bold Cat.Nos are products normally available with Legrand (India) Stockists. Cat.Nos that are not bold - delivery within 4 - 8 weeks from the date of order. Bold packing quantity is our mandatory packing. Orders to be placed by Legrand (India) Stockist in multiples of the same.



0039 54



0038 28



0038 29



4129 00



4129 08



6040 22

DX³ push button

Cat.Nos	Description	MRP* ₹ / Unit	Pack
---------	-------------	------------------	------

Dual function

4129 14	Contact - 1 NO + green indicator	3202	10/60
4129 15	Contact - 1 NC + red indicator	3202	10/60



4129 15

DX³ indicators

Single indicators - 1 module - 250 V AC

Possible to replace E10 lamps and diffusers.

E10 - 1.2 Watt, 230 V AC

4129 26	Colour - Green	932	10/100
4129 27	Colour - Red	932	10/100
4129 28	Colour - Orange	932	10/100
4129 29	Colour - Blue	932	10/100
4129 32	White + White + White	1700	10/100
4129 33	Red + Red + Red	1700	10/100
4129 34	Red + Yellow + Green	1732	10/100
4129 35	Red + Yellow + Blue	1732	10/100



4129 27

Lexic time switches

Cat.Nos	Description	MRP* ₹ / Unit	Pack
---------	-------------	------------------	------

Multifunction time delay relay

- Supply voltage : 12 to 230 V AC 50/60 Hz and DC
- Output : 8 A - 250 V AC, $\cos\phi = 1$
- Contact NO

0047 44	Multifunction time delay relay	14186	1
---------	-----------------------------------	-------	---



0047 44

Time lag switch

0047 02	Time lag switch long time (1 module)	7386	10/100
---------	---	------	--------

rex surface mounting time switches

MaxiRex

6499 15	MaxiRex 4QT (daily)	7174	1/30
6499 14A	MaxiRex 4QTB (daily with IP 53 box)	7302	1
6499 39	MaxiRex 5QW (weekly)	7722	1/30
6499 36A	MaxiRex 4QWB (weekly with IP 53 box)	8372	1



rex surface mounting time switches

Cat.Nos	Description	MRP* ₹ / Unit	Pack
---------	-------------	------------------	------

EconoRex

0499 86	EconoRex MQT (24hrs.)	7138	1/30
---------	--------------------------	------	------

Accessories

0498 32	Clip on support frame for fascia mounting of MaxiRex QTT and QWT	422	1/5
0044 09	DIN rail adaptor for MaxiRex QTT and QWT	284	1
0044 07	DIN rail adaptor for EconoRex BQTAP	278	1
6499 49	Terminal cover for 4/5 nominal time switch	352	1/30
6499 48	IP53 box for MaxiRex 4 and 5	1082	1/10

Current transformers

- ♦ Used with ammeters, electricity meters
- ♦ Supply a current of 5 A to the secondary which is proportional to the primary current.
- ♦ Fix to plate or rail EN 60715

4121 01	50/5 Precision in % - 1 Power in VA - 1.5	3271	1/12
4121 03	100/5 Precision in % - 1 Power in VA - 1.5	4452	1/12

Rex surface mounting time switches

Cat.Nos	Description	MRP* ₹ / Unit	Pack
---------	-------------	------------------	------

4121 06	200/5 Precision in % - 0.5 Power in VA - 4	4452	1/12
4121 24	200/5 Precision in % - 0.5 Power in VA - 5	4221	1/12
4121 25	400/5 Precision in % - 0.5 Power in VA - 8	4373	1/12
4121 36	600/5 Precision in % - 0.5 Power in VA - 12	4435	1/12
4121 38	800/5 Precision in % - 0.5 Power in VA - 8	6499	1/12
4121 39	1000/5 Precision in % - 0.5 Power in VA - 10	6870	1/12
4121 42	1250/5 Precision in % - 0.5 Power in VA - 12	8011	1/12

Ekinox³

Smart Solutions

The Core Brick
of your installation
is now smarter

Intelligent EI

Ekinox³ Smart Distribution Board allows to measure, monitor and control energy from anywhere. Equipped with smart products like EMDX³, CX³ EMS & intelligent accessories.

Ekinox³ helps to evaluate electrical distribution in real time seamlessly.



VTPN MCCB + METER BOARD



Scan to know more about
the product.



MIVAN CONSTRUCTION COMPATIBLE EKINOX³ DB

Mivan Construction Compatible Ekinox³ distribution boards are made with thick sheets to withstand extreme pressures during the Mivan construction process. The sleek, minimalistic and stylish design enhance the overall ambience of the spaces.



MIVAN SPN DB

5076 10M	4W
5076 11M	8W
5076 12M	12W
5076 13M	16W
5076 15M	20W

MIVAN ETPN DB

5076 70M	4W ETPN IP43
5076 71M	6W ETPN IP43
5076 72M	8W ETPN IP43
5076 73M	12W ETPN IP43
5076 74M	16W ETPN IP43

TV/Telephone DBs available on request



Scan to know more about
the product.

SALIENT FEATURES

Easily removable knock outs for cable glanding

Full proof solution

Innovative door knob

Integrated door earthing system

Door separately packed

Plain look with rounded corners

Stronger glanding plates

Nut inserts for longer installation life

Increased sheet thickness to withstand Mivan Construction challenges

Slimmest DB with 71 mm depth

IP 43 degree of protection

Wire set, Din rail components, Neutral and Earth bar packed separately in inner assembly set

Ekinox³ SPN DB's

for DX³ MCB, isolator, RCCB and RCBO

Cat.Nos	Number ofWs	No. of modules	MRP* ₹ / Unit	Pack
---------	-------------	----------------	------------------	------

- As per IEC 61439-3
- Suitable for Flush Mounting and Surface Mounting
- With 100 A Copper Busbar
- With Neutral bar, Earthbar and Cable ties for Cable management
- Fully shrouded Neutral bars
- Prefitted masking sheet
- Reversible Door for IP 43 & IP 54 DB's

IP 30 - #IK 08

5076 00	4W	4	1832	1
5076 01	8W	8	2224	1
5076 02	12W	12	2628	1
5076 03	16W	16	3210	1
5076 04	18W	18	3734	1
5076 05	20W	20	3820	1



5076 05



5076 12

IP 43 - #IK 09 with metal door

5076 10	4W	4	2402	1
5076 11	8W	8	2964	1
5076 12	12W	12	3562	1
5076 13	16W	16	4500	1
5076 14	18W	18	4646	1
5076 15	20W	20	5662	1

IP 43 - #IK 09 with acrylic door

5076 20	4W	4	3210	1
5076 21	8W	8	3718	1
5076 22	12W	12	4518	1
5076 23	16W	16	5612	1
5076 24	18W	18	5870	1
5076 25	20W	20	6216	1



5076 42

IP 54 - #IK 09

5076 40	4W	4	8330	1
5076 41	8W	8	9902	1
5076 42	12W	12	11374	1
5076 43	16W	16	12632	1
5076 44	18W	18	12770	1
5076 45	20W	20	13876	1

Ekinox³ ETPN DB's

for DX³ MCB, isolator, RCCB and RCBO

- As per IEC 61439-3
- Suitable for Flush Mounting and Surface Mounting
- With 100 A Copper Busbar for each phase
- With Neutral bar, Earthbar and Cable ties for Cable management
- Fully insulated busbar & shrouded Neutral bars
- Improved Pan assembly for ease of installation
- Prefitted masking sheet
- Reversible Door for IP 43 & IP 54 DB's
- With provision for FP MCB/Isolator/RCCB/RCBO as incomer and SP MCB's as outgoing
- Supplied with wireset
- Can be converted to PPI DB at site using conversion kit

IP 30 - #IK 08

5076 60	4W	8+12	5094	1
5076 61	6W	8+18	6320	1
5076 62	8W	8+24	7462	1
5076 63	12W	8+36	10640	1
5076 64	16W	8+48	12960	1
5076 66	20W	8+60	18086	1



5077 01



5077 11

* MRP - Maximum Retail Price Inclusive of all taxes including GST.
#IK - Refer pg - 59 for ready reckoner table.

Ekinox³ ETPN DB's

for DX³ MCB, isolator, RCCB and RCBO

Cat.Nos	Number ofWs	No. of modules	MRP* ₹ / Unit	Pack
---------	-------------	----------------	------------------	------

IP 43 - #IK 09 with metal door

5076 70	4W	8+12	5892	1
5076 71	6W	8+18	7288	1
5076 72	8W	8+24	8802	1
5076 73	12W	8+36	13054	1
5076 74	16W	8+48	16188	1
5076 76	20W	8+60	23382	1

IP 43 - #IK 09 with acrylic door

5076 80	4W	8+12	7956	1
5076 81	6W	8+18	9728	1
5076 82	8W	8+24	11448	1
5076 83	12W	8+36	17732	1
5076 84	16W	8+48	21352	1
5076 86	20W	8+60	28866	1

IP 54 - #IK 09

5076 90	4W	8+12	19972	1
5076 91	6W	8+18	24032	1
5076 92	8W	8+24	26282	1
5076 93	12W	8+36	37400	1
5076 94	16W	8+48	44450	1
5076 96	20W	8+60	52880	1

Ekinox³ Flexy DB

for DX³ DIN modular products

Cat.Nos	Number of row	No. of modules	MRP* ₹ / Unit	Pack
---------	---------------	----------------	------------------	------

- As per IEC 61439-3
- Suitable for Flush Mounting and Surface Mounting
- Completely flexible to organise the distribution as per site requirements
- Busbars to be selected as per distribution requirements
- With Neutral and Earth bars
- Fully shrouded Neutral bars
- Improved Pan assembly for ease of installation
- Prefitted masking sheet
- Reversible door for IP 43

IP 30 - #IK 08

5077 01	2 row of 14 M	28	6176	1
5077 02	3 row of 14 M	42	7732	1
5077 03	4 row of 14 M	56	8572	1

IP 43 - #IK 09 with metal door

5077 05	2 row of 14 M	28	7450	1
5077 06	3 row of 4 M	42	8906	1
5077 07	4 row of 14 M	56	9654	1
5077 14	4 row of 8 M	32	8084	1
5077 15	4 row of 10 M	40	8462	1
5077 12	3 row of 14 M MCCB for DPX ³ 160 MCCB	42	10060	1

IP 43 - #IK 09 with acrylic door

5077 09	2 row of 14 M	28	7858	1
5077 10	3 row of 14 M	42	9656	1
5077 11	4 row of 14 M	56	10940	1
5077 13	3 row of 14 M MCCB for DPX ³ 160 MCCB	42	11192	1

Bold Cat.Nos are products normally available with Legrand (India) Stockists. Cat.Nos that are not bold - delivery within 4 - 8 weeks from the date of order. Bold packing quantity is our mandatory packing. Orders to be placed by Legrand (India) Stockist in multiples of the same.

Ekinox³ TPN DB-VTPN DB's

for DX³ MCB, isolator, RCCB and RCBO

Cat.Nos	Number ofWs	No. of modules	MRP* ₹ / Unit	Pack
---------	-------------	----------------	---------------	------

- As per IEC 61439-3
- Suitable for Flush Mounting and Surface Mounting
- With 100 A Copper Busbar for each phase
- With 2 Neutral bar, 2 Earthbar and Cable ties for Cable management
- Fully insulated busbar & shrouded Neutral bars
- Improved Pan assembly for ease of installation
- Prefitted masking sheet
- Reversible Door for IP 43 & IP 54 DB's
- With provision for FP MCB/Isolator/RCCB/RCBO as incomer and SP/TP MCB's as outgoing

IP 30 - #IK 08

5077 20	4W	8+12	13560	1
5077 21	6W	8+18	14882	1
5077 22	8W	8+24	16554	1
5077 23	12W	8+36	23902	1

IP 43 - #IK 09 with metal door

5077 25	4W	8+12	14554	1
5077 26	6W	8+18	16118	1
5077 27	8W	8+24	18760	1
5077 28	12W	8+36	25240	1

IP 43 - #IK 09 with acrylic door

5077 30	4W	8+12	18884	1
5077 31	6W	8+18	20778	1
5077 32	8W	8+24	24296	1
5077 33	12W	8+36	32414	1

IP 54 - #IK 09

5077 35	4W	8+12	30270	1
5077 36	6W	8+18	32912	1
5077 37	8W	8+24	36408	1
5077 38	12W	8+36	47132	1

Ekinox³ TPN DB-VTPN DPX³ 160 MCCB DB's

- As per IEC 61439-3
- Suitable for Flush Mounting and Surface Mounting
- With 250 A Copper Busbar for each phase
- With 2 Neutral bar, 2 Earthbar and Cable ties for Cable management
- Fully insulated busbar & shrouded Neutral bars
- Improved Pan assembly for ease of installation
- Prefitted masking sheet
- Reversible Door for IP 43 & IP 54 DB's
- With provision for DPX³ 160 MCCB as incomer and SP/TP MCB's as outgoing

IP 30 - #IK 08

5077 40	4W	DPX ³ 160+12	15482	1
5077 41	6W	DPX ³ 160+18	16560	1
5077 42	8W	DPX ³ 160+24	17862	1
5077 43	12W	DPX ³ 160+36	27058	1

IP 43 - #IK 09 with metal door

5077 45	4W	DPX ³ 160+12	17604	1
5077 46	6W	DPX ³ 160+18	19980	1
5077 47	8W	DPX ³ 160+24	22012	1
5077 48	12W	DPX ³ 160+36	30008	1

* MRP - Maximum Retail Price Inclusive of all taxes including GST.
#IK - Refer pg - 59 for ready reckoner table.

Ekinox³ TPN DB-VTPN DPX³ 160 MCCB DB's

Cat.Nos	Number ofWs	No. of modules	MRP* ₹ / Unit	Pack
---------	-------------	----------------	---------------	------

IP 54 - #IK 09

5077 50	4W	DPX ³ 160+12	35522	1
5077 51	6W	DPX ³ 160+18	40448	1
5077 52	8W	DPX ³ 160+24	43944	1
5077 53	12W	DPX ³ 160+36	57892	1

Ekinox³ TPN DB-VTPN DPX³ 250 MCCB DB's

- As per IEC 61439-3
- Suitable for Flush Mounting and Surface Mounting
- With 250 A Copper Busbar for each phase
- With 2 Neutral bar, 2 Earthbar and Cable ties for Cable management
- Fully insulated busbar & shrouded Neutral bars
- Improved Pan assembly for ease of installation
- Prefitted masking sheet
- Reversible Door for IP 43 & IP 54 DB's
- With provision for DPX³ 250 MCCB as incomer and SP/TP MCB's as outgoing

IP 30 - #IK 08

5077 55	4W	DPX ³ 250+12	24788	1
5077 56	8W	DPX ³ 250+24	26352	1
5077 57	12W	DPX ³ 250+36	29086	1

IP 43 - #IK 09 with metal door

5077 58	4W	DPX ³ 250+12	28258	1
5077 59	8W	DPX ³ 250+24	32482	1
5077 60	12W	DPX ³ 250+36	34304	1

IP 54 - #IK 09

5077 61	4W	DPX ³ 250+12	41906	1
5077 62	8W	DPX ³ 250+24	47888	1
5077 63	12W	DPX ³ 250+36	55962	1

Phase selector neo DB

- As per IEC 61439-3
- Compact and sleek design
- IP 43 protection & IK 09
- Integrated LED indication in the selector switches
- With 100A copper busbar for each phase
- Fully insulated busbar & shrouded Neutral bars

Cat.Nos	Description	MRP* ₹ / Unit	Pack
---------	-------------	---------------	------

Ekinox³ TPN DB- Phase selector NEO DB's For DX³ MCB Isolator, RCCB, RCBO

5077 80N	4W NEO	15776	1
5077 81N	6W NEO	16030	1
5077 82N	8W NEO	17174	1
5077 83N	12W NEO	19340	1

Bold Cat.Nos are products normally available with Legrand (India) Stockists. Cat.Nos that are not bold - delivery within 4 - 8 weeks from the date of order. Bold packing quantity is our mandatory packing. Orders to be placed by Legrand (India) Stockist in multiples of the same.

Legrand Ekinox³ TPN DB- 7/8 segment NEO DB's

for DX³ MCB, isolator, RCCB and RCBO

Cat.Nos	Description	MRP* ₹ / Unit	Pack
---------	-------------	------------------	------

IP 42 - #IK 09 with metal door

- As per IEC 61439-3
- DB with phase segmentation and separation between Incomer and Outgoings
- Sturdy & Robust design
- With 100A copper busbar for each phase
- Colour coded Neutral Bars
- Easy to Install : Detachable frame
- 8 compartments
- More number of knockouts
- IP42 & IK09
- Supplied with wire-set
- With provision for DPX³ 160 MCCB as incomer DP MCB/Isolator/RCCB/RCBO as sub incomers and SP MCB's as outgoing

5078 85N	4W 8/7S IP42 Neo	12158	1
5078 86N	6W 8/7S IP42 Neo	13620	1
5078 87N	8W 8/7S IP42 Neo	15258	1
5078 88N	12W 8/7S IP42 Neo	18994	1

IP 42- #IK09 suitable for 160A DPX³ MCCB as incomer

5078 95N	4W 8/7S 160A MCCB IP42 Neo	16798	1
5078 96N	6W 8/7S 160A MCCB IP42 Neo	19216	1
5078 97N	8W 8/7S 160A MCCB IP42 Neo	22206	1
5078 98N	12W 8/7S 160A MCCB IP42 Neo	25072	1

Ekinox³ TPN DB - 7 segment DB's

for DX³ MCB, isolator, RCCB and RCBO

- As per IEC 61439-3
- Separate compartment for incomer, sub-incomer & outgoing devices
- Suitable for Flush Mounting and Surface Mounting
- With 100 A Copper Busbar for each phase
- With Neutral bar, Earthbar and Cable ties for Cable management
- Fully insulated busbar & shrouded Neutral bars
- With provision for FP MCB/Isolator/RCCB/RCBO as incomer, DP RCCB/RCBO as sub incomer and SP MCB's as outgoing
- Supplied with wire set
- DB with phase segmentation and separation between incomer and outgoings

IP 30 - #IK 08

5078 80	4W	8+12+12	■	1
5078 81	6W	8+12+18	■	1
5078 82	8W	8+12+24	■	1
5078 83	12W	8+12+36	■	1

* MRP - Maximum Retail Price Inclusive of all taxes including GST.
■ Price available on request.
#IK - Refer pg - 59 for ready reckoner table.

Ekinox³ TPN DB - 7 segment DB's

for DX³ MCB, isolator, RCCB and RCBO

Cat.Nos	Description	No. of modules	MRP* ₹ / Unit	Pack
---------	-------------	----------------	------------------	------

IP 43 - #IK 09 with metal door

5078 85	4W	8+12+12	■	1
5078 86	6W	8+12+18	■	1
5078 87	8W	8+12+24	■	1
5078 88	12W	8+12+36	■	1

Ekinox³ TPN DB - 7 segment DB's for 160 A DPX³ MCCB

- As per IEC 61439-3
- DB with phase segmentation and separation between incomer and Outgoings
- Suitable for Flush Mounting and Surface Mounting
- With 100 A Copper Busbar for each phase
- With Neutral bar, Earthbar and Cable ties for Cable management
- Fully Color Shrouded Insulated bus bar and Neutral bars
- With provision for DPX³ 160 MCCB as incomer DP MCB/Isolator/RCCB/RCBO as sub incomers and SP MCB's as outgoing
- Supplied with wire set

IP 30 - #IK 08

5078 90	4W	DPX ³	■	1
	160+12+12			
5078 91	6W	DPX ³	■	1
	160+12+18			
5078 92	8W	DPX ³	■	1
	160+12+24			
5078 93	12W	DPX ³	■	1
	160+12+36			

IP 43 - #IK 09 with metal door

5078 95	4W	DPX ³	■	1
	160+12+12			
5078 96	6W	DPX ³	■	1
	160+12+18			
5078 97	8W	DPX ³	■	1
	160+12+24			
5078 98	12W	DPX ³	■	1
	160+12+36			

Ekinox³ Metal enclosures

for DX³ MCB, RCCB, RCBO and DPX³ MCCB's

- As per IEC 61439-3
- Suitable for Flush Mounting and Surface Mounting
- Suitable for protection of appliances like AC/Geyser etc
- Supplied with Neutral Links
- With provision for mounting modular devices

#IK 08

5078 10	10 A SP, 2P+E	1	2324	1
5078 11	20 A SP, 2P+E	1	2504	1
5078 14	20 A DP, 2P+E	2	2720	1
5078 17	20 A TP, 3P+E	3	4608	1
5078 18	32 A TP, 3P+E	3	5468	1
5078 20	20 A DP RCBO, 2P+E	4	2632	1
5078 21	20 A FP RCBO, 2P+E	8	4600	1
5078 22	32 A FP RCBO, 3P+E	8	5424	1

Bold Cat.Nos are products normally available with Legrand (India) Stockists. Cat.Nos that are not bold - delivery within 4 - 8 weeks from the date of order. Bold packing quantity is our mandatory packing. Orders to be placed by Legrand (India) Stockist in multiples of the same.



5078 86



5078 86N



5078 95



5078 14



5078 22

Ekinox³ P-17 tempra plug & socket DB's

for DX³ MCB, RCCB and RCBO

Cat.Nos	Description	No. of modules	MRP* ₹ / Unit	Pack
---------	-------------	----------------	------------------	------

- As per IEC 61439-3
- Suitable for Flush Mounting and Surface Mounting
- Supplied with Neutral Links
- With provision for mounting modular devices

5078 60



5078 62



5078 64



5077 91



5077 93

#IK 08

5078 60	16 A 2P+E-DP	2	3796	1
5078 63	32 A 2P+E-DP	2	4102	1
5078 61	32 A 3P+E-FP	8	6868	1
5078 62	32 A 3P+N+E-FP	8	6948	1
5078 64	63 A 3P+N+E-FP	8	17294	1

Ekinox³ metal enclosures

for DX³ MCB, RCCB, RCBO and DPX³ MCCB's

- As per IEC 61439-3
- For independent mounting of DX³ MCB, RCCB, RCBO, DPX³ 160, DPX³ 250, DPX³ 630 & DRX MCCB's
- #IK 08

#IK 08

5077 90	SP enclosure	1	640	1
5077 91	DP enclosure	2	922	1
5077 92	TP enclosure	3	918	1
5077 93	FP enclosure	4	922	1
5077 94	FP RCBO enclosure	8	1542	1

Metal one way enclosures for MCCB

5078 01	DPX ³ 160 MCCB enclosure	3&4	5244	1
5078 02	DPX ³ 250 MCCB enclosure	3&4	9222	1
5078 04	DPX ³ 630 MCCB enclosure	3&4	14324	1
5078 05	DRX 100 MCCB enclosure-TP	3	2830	1
5078 06	DRX 100 MCCB enclosure-FP	4	2668	1

Ekinox³ cable end box

Cat.Nos	Description	MRP* ₹ / Unit	Pack
---------	-------------	------------------	------

- Useful for keeping extra cables
- Possible to mount on the top or bottom of the DB
- Provision for mounting terminal blocks
- Can be used as a terminal box adaptor also

For IP 30 DB's

5079 10	For SPN 4 W IP30	890	1
5079 12	For SPN 8 W IP30	1032	1
5079 14	For SPN 12 W/ VTPN/Flexy	1166	1
5079 16	For SPN 16 W/ ETPN 6W DB	1638	1
5079 25	For ETPN 8W DB	2944	1
5079 27	For ETPN 12W DB	3812	1
5079 29	For ETPN 16W DB	3788	1
5079 31	For ETPN 18W DB	4100	1
5079 33	For ETPN 20W DB	4166	1
5079 35	For ETPN 4W VTPN/FLEXY MCB	1156	1
5079 37	For all VTPN MCCB DBS	4258	1

5079 12

5079 16

5079 27



5079 43

Ekinox³ metal enclosures

for DX³ MCB, RCCB, RCBO and DPX³ MCCB's

Cat.Nos	Description	MRP* ₹ / Unit	Pack
---------	-------------	------------------	------

For IP 43 DB's

5079 11	For SPN 4W DB	1020	1
5079 13	For SPN 8W DB	1244	1
5079 15	For SPN 12W/ VTPN/Flexy DB	1396	1

For IP 43 DB's

5079 17	For SPN 16W/ ETPN 6W DB	1982	1
5079 18	For SPN 18W DB	1984	1
5079 19	For SPN 20/ETPN 8W DB	2072	1
5079 28	For ETPN 12W DB	4448	1
5079 30	For ETPN 16W DB	4532	1
5079 32	For ETPN 18W DB	4708	1
5079 34	For ETPN 20W DB	4888	1
5079 36	For all ETPN 4W/VTPN/Flexy MCB	1396	1
5079 38	For all VTPN MCCB DBs	4954	1
5079 00▼	For 7 segment 4W DB	4186	1
5079 01▼	For 7 segment 6W DB	4594	1
5079 02▼	For 7 segment 8W DB	5124	1
5079 03▼	For 7 segment 12W DB	5792	1

Ekinox³ DBs

meter box

- Suitable for Mounting DX³ Metering products
- Possible to mount on the top or bottom of the DB
- Provision for mounting Ammeter/Voltmeter/ASS/VSS
- #IK09

Provision for mounting meters

5079 40	For VTPN MCB INCOM IP 30	5644	1
5079 41	For VTPN MCB INCOM IP 43	6926	1
5079 42	For VTPN MCCB INCOM IP 30	6276	1
5079 43	For VTPN MCCB INCOM IP 43	7992	1

Per phase Isolation kit

5079 44	PPI conversion kit for ETPN 4W DB	3442	1
5079 45	PPI conversion kit for ETPN 6W DB	3880	1
5079 46	PPI conversion kit for ETPN 8W DB	4424	1
5079 47	PPI conversion kit for ETPN 12W DB	4978	1
5079 48	PPI conversion kit for ETPN 16W DB	5566	1

Panel locks

5079 52	Panel knob for IP 43	380	1
5079 51	Panel knob with key	792	1

* MRP - Maximum Retail Price Inclusive of all taxes including GST.

▼ Compatible with Ekinox3 and NEO DB.

#IK - Refer pg - 59 for ready reckoner table.

Bold Cat.Nos are products normally available with Legrand (India) Stockists. Cat.Nos that are not bold - delivery within 4 - 8 weeks from the date of order. Bold packing quantity is our mandatory packing. Orders to be placed by Legrand (India) Stockist in multiples of the same.

Ekinox™ distribution boards

Cat.Nos	Number ofWs	MRP* ₹ / Unit	Pack
---------	-------------	------------------	------

Plexo³ boxes for DX³

Self-extinguishing: resistance to incandescent wire 650 °C
Conform to EN 60439-3

Weatherproof cabinets - IP 65 - IK 09 - Class II

Door and cabinet fully reversible

Removable chassis and faceplates from 2-row versions up
2-position rail for modular products and moulded cases

Spacing between rails 150 mm

Box colour light grey L750A, cover colour dark grey
R746A

6019 32	2 (+1) Module	2088	1
6019 94	4 Module	2256	1
6019 96	6 Module	2576	1
6019 98	8 Module	3220	1

Cabinets with 12 modules per row

6018 31	1 row 12 modules	5072	1
6018 32	2 rows 24 modules	7036	1
6018 33	3 rows 36 modules	9806	1

Cabinets with 18 modules per row

6018 35	18 modules x 1 row	6254	1
6018 36	18 modules x 2 rows	10824	1
6018 37	18 modules x 3 rows	15218	1
6018 38	18 modules x 4 rows	22778	1

Multifunction sleeves for P17

0019 17	For 2 row cabinets	4022	1
0019 18	For 3 row cabinets	6030	1
0019 67	Joining kit	1138	1

Plexo-S

6018 82	Waterproof cabinet 2M	1668	1
6018 84	Waterproof cabinet 4M	1964	1
6018 86	Waterproof cabinet 6M	2258	1
6018 88	Waterproof cabinet 8M	2780	1
6018 92	Waterproof cabinet 12M	4458	1
6018 94	Waterproof cabinet 24M	6140	1

Accessories

Fixing lugs and blanking plates

0019 69	Set of 4 wall mounting lugs for Plexo, Plexo ³ cabinets and P 17 combined units	■	1
0019 61	5, seperable into modules or 1/2 module Grey RAL 7046	■	20

Direct piercing end caps

0019 56	Pack consisting of 100 ø20 mm ISO and caps	■	1
0019 57	Pack consisting of 100 ø25 mm ISO and caps	■	1

Earth terminal and neutral terminal blocks

Brass terminal block with isolated support conform to IEC 60998-2-1/2-2

1348 00	1 X (2x16 ² + 2x10 ²); ICC : 6kA	■	1
1348 01	1 X (3x16 ² + 3x10 ²); ICC : 6kA	■	1
1348 10	2 X (2x16 ² + 2x10 ²); ICC : 6kA	■	1
1348 11	2 X (3x16 ² + 3x10 ²); ICC : 6kA	■	1

Note: For Plexo3 Box with integrated Neutral & Earth Bars contact nearest Sales Office

* MRP - Maximum Retail Price Inclusive of all taxes including GST.

Refer instruction manual for MIVAN (Aluminum shuttering) compatible DB's

Distribution boards

Cat.Nos	No. of devices connected	No. of 17.5 mm modules	MRP* ₹ / Unit	Pack
---------	--------------------------	------------------------	------------------	------

Supply busbars - insulated

63 A copper

Pin type

SP I/C & SP O/G

4049 26	13	13	416	1
4049 37	57	57	1618	1

SPN I/C & SPN O/G

4049 38	6	12	732	1
4049 39	28	56	3026	1

TPN I/C & SPN O/G

4049 40	5	12	752	3/30
4049 41	27	56	7384	5/10

TP I/C & TP O/G

4049 42	4	12	758	1
4049 43	19	57	7424	1

FP I/C & FP O/G

4049 44	3	12	1824	3/30
4049 45	14	56	7384	5/10

Fork type

SP I/C & SP O/G

4049 11	13	12	416	1
4049 12	57	57	1588	1

SPN I/C & SPN O/G250

4049 14	28	56	3026	1
---------	----	----	------	---

TP I/C & TP O/G

4049 17	4	12	752	1
4049 18	19	57	3798	1

FP I/C & FP O/G

4049 20	14	56	7384	5/10
---------	----	----	------	------

Cat.Nos	Description	MRP* ₹ / Unit	Pack
---------	-------------	------------------	------

Accessories for fork and pin type busbars

4049 89	End caps for SP	8	6
4049 90	End caps for DP & TP	48	6
4049 91	End caps for FP	90	20/840

Cat.Nos	Number of Ws	MRP* ₹ / Unit	Pack
---------	--------------	------------------	------

Blanking plates

6014 70	-	16	10
---------	---	----	----

Bold Cat.Nos are products normally available with Legrand (India) Stockists. Cat.Nos that are not bold - delivery within 4 - 8 weeks from the date of order. Bold packing quantity is our mandatory packing. Orders to be placed by Legrand (India) Stockist in multiples of the same.

NEW

PLEXO-S

THE GO-TO RANGE FOR SUCCESSFUL SITES



FEATURES

- **Compact Design** - Adapt to any configuration.
- **Environmentally Friendly** - Elimination of single-use plastics
- **Reversible Front Cover** - Providing flexibility for all spaces.
- **Patented Alignment System** - To make it easier and quick installation.

NEW PLEXO CABINETS A SENSE OF FAMILY

The new range of Plexo cabinets uses the same aesthetic as the range of Plexo3 weatherproof cabinets. They feature a sleek design with a transparent cover and rounded corners, creating an impression of optimum quality. Plexo-s meets a need for weatherproofing on sites exposed to damp, especially outdoors, in sectors of industry, commerce and also the residential sector. The minimalist design of this range is combined with an environmentally-responsible approach.



2 MODULES



2 MODULES



6 MODULES



8 MODULES

Ekinox³

For converting ETPN DB to PPI DB

PPI DB IP 30 - IK 08

No. of ways	Combine		No. of modules
	ETPN DB	PPI Kit	
4 way	4 way 507660	4 way kit 507944	8+12
6 way	6 way 507661	6 way kit 507945	8+18
8 way	8 way 507662	8 way kit 507946	8+24
12 way	12 way 507663	12 way kit 507947	8+36
16 way	16 way 507664	16 way kit 507948	8+48

PPI DB IP 43 - IK 09 with metal door

No. of ways	Combine		No. of modules
	ETPN DB	PPI Kit	
4 way	4 way 507670	4 way kit 507944	8+12
6 way	6 way 507671	6 way kit 507945	8+18
8 way	8 way 507672	8 way kit 507946	8+24
12 way	12 way 507673	12 way kit 507947	8+36
16 way	16 way 507674	16 way kit 507948	8+48

PPI DB IP 43 - IK 09 with acrylic door

No. of ways	Combine		No. of modules
	ETPN DB	PPI Kit	
4 way	4 way 507680	4 way kit 507944	8+12
6 way	6 way 507681	6 way kit 507945	8+18
8 way	8 way 507682	8 way kit 507946	8+24
12 way	12 way 507683	12 way kit 507947	8+36
16 way	16 way 507684	16 way kit 507948	8+48

PPI DB IP 54 - IK 09

No. of ways	Combine		No. of modules
	ETPN DB	PPI Kit	
4 way	4 way 507690	4 way kit 507944	8+12
6 way	6 way 507691	6 way kit 507945	8+18
8 way	8 way 507692	8 way kit 507946	8+24
12 way	12 way 507693	12 way kit 507947	8+36
16 way	16 way 507694	16 way kit 507948	8+48

IK

Protection against mechanical impact: protection index - IK

According to standard:

IEC 62262, BS EN 62262 and NF EN 62262

• This table can be used to ascertain the resistance of a product to an impact given in Joules from the IK code (graduated from 00 to 10)

It can also be used to ascertain the correspondence with the old IP code 3rd digit and the corresponding external "Ag" conditions

IK	Tests	Impact energy (in Joules)	"AG" of NF C 15-100
IK 00		0	
IK 01		0.15	
IK 02		0.2	AG1
IK 03		0.35	
IK 04		0.5	
IK 05		0.7	
IK 06		1	
IK 07		2	AG2
IK 08		5	AG3
IK 09		10	
IK 10		20	AG4

IPXX

Index of protection

IP*** index of protection of enclosures of electrical equipment in accordance with standards IEC 529, BS 5490, DIN 400 50 and NF C 20-010
Up to 1000 V± and 1500 V= (standard UTE C 20 010)

1st figure:- protection against solid bodies

IP	tests	
0		No protection
1		Protected against solid bodies larger than 50 mm (eg:- accidental contact with the hand)
2		Protected against solid bodies larger than 12 mm (eg:- finger)
3		Protected against solid bodies larger than 2.5 mm (eg:- tools, wires)
4		Protected against solid bodies larger than 1 mm (eg:- fine tools and small wires)
5		Protected against dust (no harmful deposit)
6		Completely protected against dust

2nd figure:- protection against liquids

IP	tests	
0		No protection
1		Protected against vertically-falling drops of water (condensation)
2		Protected against drops of water falling at up to 15° from the vertical
3		Protected against drops of rain water at up to 60° from the vertical
4		Protected against projections of water from all directions
5		Protected against jets of water from all directions
6		Protected against jets of water of similar force to heavy seas
7		Protected against the effects of immersion
8		Protected against prolonged effects of immersion under pressure

The contents of all the above charts are for guidance only, if you have any doubt as to the interpretation of the information contained therein, please refer either to the standard itself or contact Legrand.

In accordance with our policy of continuous improvement, Legrand reserves the right to change specifications and designs without notice. All information given here is correct at the time of going to press.

XCP SANDWICH BUSBAR TRUNKING.

ZUCCHINI BUSBAR FOR POWER APPLICATIONS



FEATURES

- Range **630A – 5000A (Al) & 800A – 6300A (Cu)** in single Enclosure
- **XCP_HP tested for Higher Ambient 50 °C (Al) & 55 °C (Cu)**
- The busbar trunking has been tested and approved according to **IEC 61439-6 for IP55 and IP65**
- **Fire resistance** tested in accordance with IEC 60331-1 @ **830 Deg for 3hr**
- Insulation Class **F (155 °C)**
- Superior strength with impact **resistance IK10 as per IEC EN 60068-2-62**
- The XCP range, including tap-off boxes, comply with **seismic requirement of ZPA 1.5g** in accordance with IEEE Std 693-2018.
- **Optional sprinkler kit accessory available** that makes the busbar system resistant to sprinkler test

XCP is part of the Zucchini range used for power distribution in medium-large installations; it is also particularly suitable in rising main applications within buildings used for the service sector (banks, insurance, commercial headquarters, skyscrapers, data centers, etc.). The ultra-compact dimensions of XCP enhance the short-circuit stress resistance features, reduce the impedance of the circuit by limiting voltage drops and enables the installation of high-power electrical systems even in extremely cramped spaces



Horizontal elbow with double bar



Vertical elbow with double bar



Connection interfaces

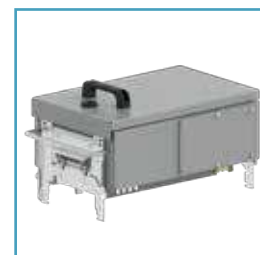

Plastic tap-off boxes plug-in type



Scan to know more about the product.

ARTEOR™

VERSATILITY AND A
GLOBAL VISION FOR ANY
INSTALLATION LEVEL

Arteor™ is the innovative answer to the increasingly complex requirements in the building business all over the world. Arteor™ excels by its unique aesthetics and a rich choice of innovative designs and ergonomical options. The range extends from wiring devices, through innovative IoT based solutions, up to fully networked home automation systems based on BUS technology, which can also be integrated into third party solutions.



Scan to know more about
the product.

ARTEOR™



DESIGN FOR A GLOBAL LIFESTYLE

DESIGN OPTIONS FOR CONTROL FUNCTIONS

Arteor™ offers a wide choice of ergonomics and finishes to satisfy the most demanding customers. All stand-alone control functions are available in two shapes of rockers – round or square – and in three colours – white, magnesium and champagne.



Round rocker
White



Round rocker
Magnesium



Round rocker
Champagne



Square rocker
White



Square rocker
Magnesium



Square rocker
Champagne



ARTEOR™

HOME

THE IDEAL SOLUTION,
ALWAYS AND
EVERYWHERE

Its versatility makes Arteor™ the ideal choice for every kind of project, anywhere in the world at any installation level. Arteor™ suits any requirement in terms of design and function for every kind of building, from residential to commercial.



TV socket



Skirting light



1-way switch - 3 gang



USB Charger
Type C+C - 63W



6AX switch*



Skirting light



USB charger
Type C+C - 30W



Triple RCA socket



Time delay switch

*Switch compatible with LED light

ARTEOR™

OFFICE AND HOTEL SOLUTIONS

Offices and collective spaces require specific solutions and maximum flexibility: lighting adapted to each situation (meeting, conference, etc.), access security, comprehensive multimedia connections. The Arteor™ range meets all these expectations with perfect adaptability.

OFFICE

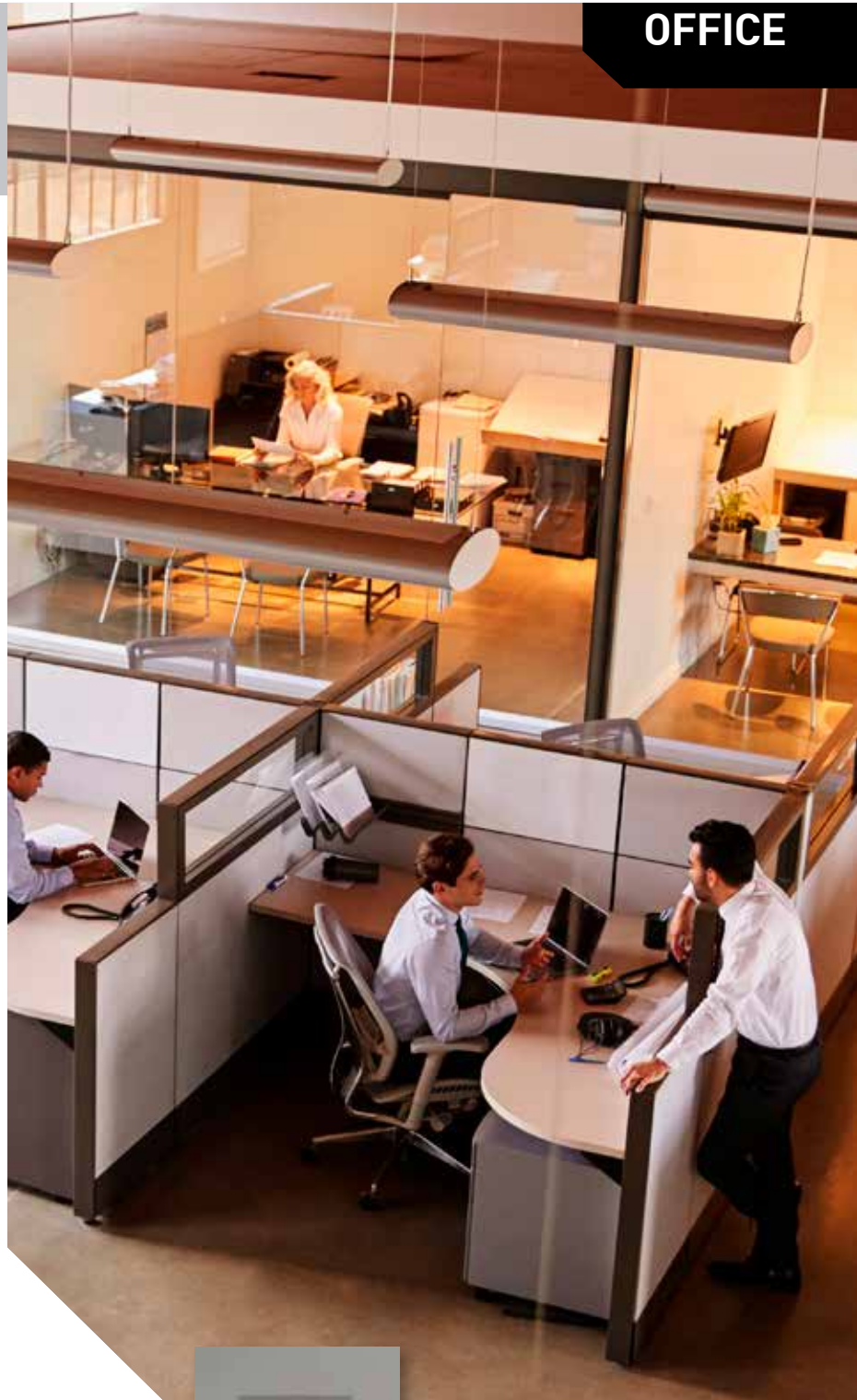

Automatic switch



6 A 1 way switch



USB socket



RJ45



Preterminated HDMI sockets



Female HD15 + Jack



USB Charger
Type C - 45W

HOTEL

From hotel room door to the beside table, Arteor™ provides all the solutions for the specific need of today's hotel industry. Comfort that extends to the hotel's communal areas, whether dedicated to the relaxation or work. The multitude of small details, gives the comfort feeling of being at home to the traveller.



Data sockets



4-Scenario touch control



S-Video socket



Keycard switch



External unit



Desk and entrance light

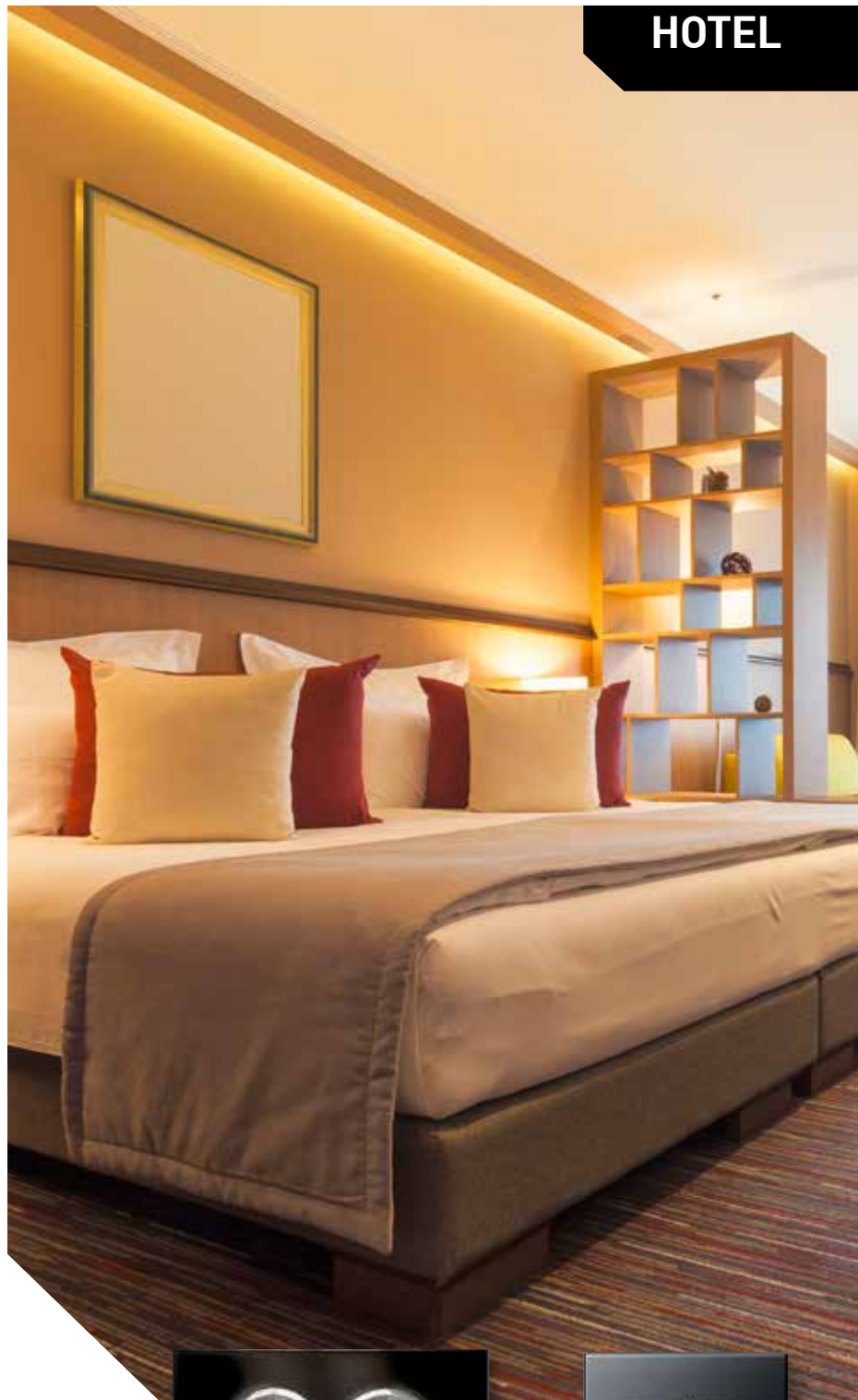

Bed light and curtain aswitch



Internal unit

ARTEOR™

A RICH CHOICE
OF FINISHES

NEUTRAL



MIRROR



GRAPHIC



METAL



Graphite



Dark Bronze



Green Apple

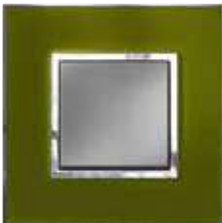

Dark Baroque



WOOD

Grey Oak



SIGNATURE

Cube

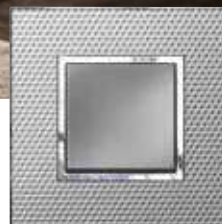

ARTEOR™

VERSATILITY AND
MODULARITY FOR
UNRIVALLED
FLEXIBILITY

Arteor™ is a modular range offering maximum flexibility in terms of installation and configuration.



Features that set ARTEOR™ apart



- ① Finger-proof terminals for IP 20 protection against accidental contact.
- ② Captive "never to loose screws"



- ① Tunnel terminals preventing screwdrivers from slipping.
- ② Laser marking on mechanisms. Arrow showing the correct orientation of the mechanism.
- ③ The latest IS 3854 : 1997.



Sockets with ISI* mark, conforming to IS 1293. Fan regulator with ISI* mark, conforming to IS 11037.



Fully shrouded internal mechanism under the rocker preventing visibility of sparks.



- ① Stripping templates on sockets for stripping off exact length of insulation.



Sockets are shuttered for child's safety against electric shocks.



Possibility of weather proofing mechanisms using Plexo IP 55 and IP 66 boxes.



For switches with LED lamps, life of LED is 50000 burning hours. Consumes power (0.76W) next to NIL.

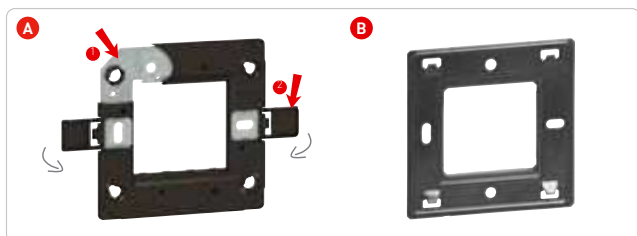

A. For all high end plates
Metal frame providing solid support to base.
Bi-material frame - electrical safety IP20.
Screw caps can be closed once the support frame is installed, ensuring total insulation.



2x2 way switch - 3 controls possible in 2 module plate. In round and square design possible.



Mechanisms compatible with DLP trunking systems, columns, floor boxes and VDI installations.

*Please referred to the description for ISI mark sockets and Fan Regulators.

ARTEOR™ MyHOME

THE BEAUTIFUL SIMPLICITY OF HOME AUTOMATION

Put the finishing touch to your homes with the hometouch screen. get total control of your home with just a touch. see the full range of home automation solutions provided by arteor MyHOME on legrand.co.in

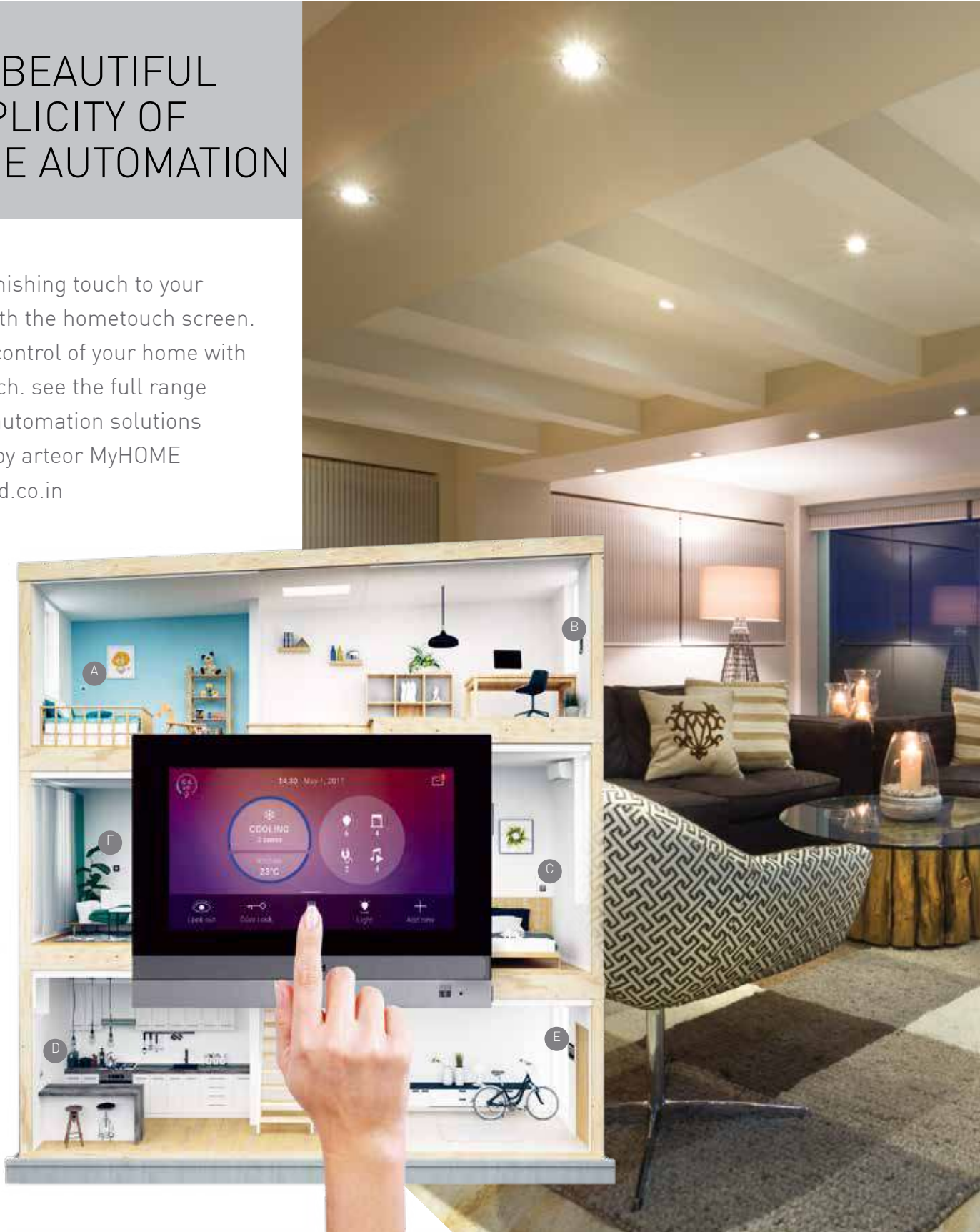

THE FINISHING TOUCH



USB CHARGING SOLUTIONS

NOW AVAILABLE WITH FAST CHARGING AND INDUSTRY FIRST LAPTOP CHARGING SOLUTIONS



NEW MOBILE CHARGING SOLUTION



USB Type: A Type
Rating: 15W-3A - 1M



USB Type: A+A Type
Rating: 15W-3A - 1M



USB Type: A+C Type
Rating: 15W-3A - 1M



USB Type: C+C Type
Rating: 15W-3A - 1M



USB Type: C Type
Rating: 20W-PD - 1M



RANGES: ^{LIVING} now | ARTEOR™ | Myrius™ | Lyncus™ | Allzy™

NEW MOBILE AND LAPTOP CHARGING SOLUTIONS

Compatible for laptop charging

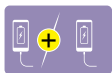

USB Type: C+C Type
Rating: 30W-PD - 2M



USB Type: C Type
Rating: 45W-PD - 2M



USB Type: C+C Type
Rating: 63W-PD - 3M

RANGES: ^{LIVING} now | ARTEOR™ | Myrius™ | Lyncus™
Mylicnc | Allzy™

RANGES: ARTEOR™ | Myrius™
Lyncus™ | Allzy™

Arteor™ square - white mechanism

Cat.Nos	Description	MRP* ₹ / Unit	Pack
---------	-------------	------------------	------

Switches – 6A - 250V AC

5734 00	6A - Switch - SP - 1 Way - 1 Module	212	1/20/200
5734 01	6A - Switch - SP - 1 Way - with Indicator - 1 Module	372	1/20/200
5734 02	6A - Switch - SP - 2 Way - 1 Module	330	1/20/200
5734 03	6A - Switch - SP - 2 Way - with Indicator - 1 Module	466	1/20/200

5734 01

Switches – 10A - 250V AC

5734 50	10A - Switch - SP - 1 Way - 2 Module	384	1/10/100
5734 51	10A - Switch - SP - 2 Way - 2 Module	454	1/10/100
5720 37	10A - Switch - SP - 2 Way - with Indicator & Label Holder - 2 Module	2158	5/50
5720 38	10A - Intermediate Switch - 250V AC - 2 Module	2584	10/100

5734 50

5720 37

Switches – 20A - 250V AC

5734 10	20A - Switch - SP - 1 Way - 1 Module	440	1/20/200
5734 52	20A - Switch - SP - 1 Way - 2 Module	526	1/10/100
5720 63	20A - Switch - SP - 1 Way - with Indicator - 1 Module	452	1/20/200
5734 11	20A - Switch - SP - 2 Way - with Indicator - 1 Module	634	1/20/200
5720 42	20A - Switch - SP - 2 Way - with Indicator - 2 Module	690	10/100
5720 43	20A - Switch - 3 Gang - 1 Way - 2 Module	1240	10/100
5720 44	20A - Switch - 3 Gang - 2*2 Way + 1*1 Way - 2 Module	1358	10/100
5734 54	20A - Switch - DP - 1 Way - with Indicator - 2 Module	976	1/10/100
5720 49	20A - Switch - DP - 1 Way - with Indicator & Water Heater Marking - 2 Module	1026	10/100

5734 10

5720 43

5720 49

Accessory for switch with indicator

5738 06	LED for Switch - with Indicator (Blue)	76	5/50
---------	--	----	------

Switches – 25A - 250V AC

5734 17	25A - Switch - 1 Way - with Indicator - 1 Module	590	1/20/200
---------	--	-----	----------

Switches – 32A / 40A - 250V AC

5734 12	32A - Switch - DP - 1 Way - with Indicator - 2 Module	1392	10/100
5735 30	40A - Switch - DP - 1 Way - with Indicator - fits on 1/2 Module Box	1604	1/5/20

5720 12

* MRP - Maximum Retail Price Inclusive of all taxes including GST.
■ Price available on request

Arteor™ square - white mechanism

Cat.Nos	Description	MRP* ₹ / Unit	Pack
---------	-------------	------------------	------

Push button – 6A - 250V AC

5734 13	6A - Bell Push - SP - 1 Way - 1 Module	356	1/20/200
5734 59	6A - Bell Push - SP - 1 Way - 2 Module	498	1/10/100
5734 04	6A - Push Button - SP - 1 Way - 1 Module	374	1/20/200
5734 05	6A - Push Button - SP - 1 Way - with Indicator - 1 Module	474	1/20/200
5734 14	6A - Bell Push - SP - 1 Way - with Indicator - 1 Module	470	1/20/200
5734 60	6A - Bell Push - SP - 1 Way - with Indicator - 2 Module	670	1/10/100

5734 13

5734 59

5734 05

5734 14

Electric roller blinds control

5722 20	Double Switch for Electric Shutter - 2 Module	868	10/100
---------	---	-----	--------

5722 20

Dimmers and fan regulators

5734 62	Light Dimmer - 60 to 400 Watts - 2 Module	1398	1/10/100
5734 16	Fan Step Regulator - 100 Watts - ISI - 1 Module	1150	1/5/50
5734 63	Fan Step Regulator - 100 Watts - ISI - 2 Module	1422	1/10/100
5734 69	Fan Step Regulator - 120 Watts - ISI - 2 Module (for 48 & 56" Fans)	1518	1/10/100
5734 68	Fan Step Regulator - for Energy Saving Fans - 2 Module	1514	1/10/100
5736 53	Fan Regulator - 8 Step - 100 Watts - 2 Module	1354	10/100

5734 62

5734 63

Bold Cat.Nos are products normally available with Legrand (India) Stockists. Cat.Nos that are not bold - delivery within 4 - 8 weeks from the date of order. Bold packing quantity is our mandatory packing. Orders to be placed by Legrand (India) Stockist in multiples of the same.

Arteor™ square - white mechanism

Cat.Nos	Description	MRP* ₹ / Unit	Pack
Indian standard sockets			
5734 24	6A - Socket - with Shutter - 3 Pin - ISI - 2 Module	290	1/20/200
5734 71	6/16A - Socket - with Shutter - 3 Pin - Indian - ISI - 2 Module	586	1/10/100
5734 67	6/16A - Socket - with Shutter - 3 Pin - Indian - ISI - 3 Module	702	1/5/50
5735 10	16A - Socket Shutter with Switch - 3 Pin - 2P+E - Indian - 3 Module	1648	5/50
5734 66	25A - Socket - with Shutter - 2 Module	712	1/10/100
Energy plugs			
5738 86	6A - Plug	140	1/10/100
5738 88	16A - Plug	188	1/10/100
5738 07	25A - Plug	216	1/10/100
USB chargers (IS13252 (Part 1) / IEC 60950-1)			
5734 41	USB Charger - 1500mA - Type A - 1 Module	2224	1/5/50
5734 36	USB Charger - 1500mA - Type C - 1 Module	2244	1/5/50
5716 80	USB Charger - 3000mA/15 Watts - Type A - 1 Module	2618	1/5/50
5716 84	USB Charger - 3000mA/15 Watts - Type A + A - 1 Module	2962	1/5/50
5716 88	USB Charger - 3000mA/15 Watts - Type A + C - 1 Module	3302	1/5/50
5716 92	USB Charger - 3000mA/15 Watts - Type C + C - 1 Module	3698	1/5/50
5716 96	USB Charger - Power Delivery - 20 Watts - Type C - 1 Module	5062	1/5/50
5734 81	USB Charger - Power Delivery - 30 Watts - Type C + C - 2 Module	7574	1/3/30
5754 81	USB Charger - Power Delivery - 45 Watts - Type C - 2 Module	9774	1/3/30
5754 90	USB Charger - Power Delivery - 63 Watts - Type C + C - 3 Module	11972	1/5/20

* MRP - Maximum Retail Price Inclusive of all taxes including GST.
■ Price available on request

Arteor™ square - white mechanism

Cat.Nos	Description	MRP* ₹ / Unit	Pack
Data and voice			
5734 27	Telephone Socket - Double RJ11 - 1 Module	522	1/20/200
5734 26	Telephone Socket - RJ11 - with Shutter - 1 Module	304	1/20/200
5734 29	Information Socket - RJ45 - Cat 5E - UTP - 1 Module	641	1/20/200
5734 75	Information Socket - RJ45 - Cat 5E - UTP - 2 Module	684	1/10/100
5734 28	Information Socket - RJ45 - Cat 6 - UTP - 1 Module	980	1/20/200
5734 74	Information Socket - RJ45 - Cat 6 - UTP - 2 Module	1029	1/10/100
TV sockets			
5734 25	TV Co - axial Socket - 1 Module	314	1/20/200
Electronic chime			
5734 43	Bell Ding Dong - 230V - 2 Module	476	1/10/100
Buzzer			
5734 42	Buzzer - 230V - 1 Module	1702	20/200
Bell call indicator & register - 6A - 250V AC			
5734 15	6A - Bell Call Indicator - SP - with Register - 1 Way - 1 Module	2130	1/20/200
5736 06	Set of Labels for Bell Call Indicator	574	5/50
Skirting light			
5734 64	Skirting Light - with LED - 230V - 3 Module	1144	1/10/100
5722 26	Skirting Light - with Detector (LED) - 230V - 2 Module	17438	1/20
Lighting			
5724 53	Over Door Light Unit (Red) - 2 Module	644	10/100
5722 23	Over Door Light Unit (White) - 2 Module	528	10/100
5724 52	Indicator Unit - with Transparent LED & Colored Labels - 1 Module	856	10/100
MCB			
5723 61	16A - MCB - SPN - 2 Module	4860	1

Bold Cat.Nos are products normally available with Legrand (India) Stockists. Cat.Nos that are not bold - delivery within 4 - 8 weeks from the date of order. Bold packing quantity is our mandatory packing. Orders to be placed by Legrand (India) Stockist in multiples of the same.

Arteor™ square - white mechanism

Cat.Nos	Description	MRP* ₹ / Unit	Pack
---------	-------------	------------------	------

Hospitality function

Hotel "DND and MMR" functions

5734 61	External DND & MMR Control Unit - with Bell Push - 2 Module	2288	1/5/50
5734 58	Internal DND & MMR Control Unit - 2 Module	1642	10/100

Hotel keycard switch

5722 44	15A - Key Card Switch - 230V - 2 Module	6244	1/0/10
5722 59	Key Fob for Key Card Switch	1702	10/50

Shaver socket

5721 53	Shaver Socket - 120/230V- with Earth Connector	6490	1
---------	--	------	---

Time switch

5720 55	Time Delay Switch - 2 Module	8086	1/20
---------	------------------------------	------	------

Audio-video sockets

5722 72	Double RCA Socket (Audio) - 1 Module	4797	1/20
5722 73	Triple RCA Socket (Audio & Video) - 1 Module	4301	1/20
5722 74	Female 3.5mm Jack - 1 Module	4771	1/20
5722 76	Female BNC 75 Jack - 1 Module	5034	1/20
5722 83	Female XLR Jack - 2 Module	7401	1/20
5720 97	Preterminated Sockets Female Hd15 - 1 Module	6643	1
5720 96	Preterminated HDMI Socket - 1.4 - 1 Module	7883	1
5722 84	Line Dying Down - 100V (25 - 30W) - 2 Module	12331	1
5722 77	Male XLR Jack - 2 Module	6772	1/20
5722 78	Female 3.5mm Jack - Solder - 1 Module	3937	1/20
5722 75	USB Socket - 1 Module	3708	1/20
5722 88	Female HD15 + Jack 3.5mm - 2 Module	5350	1/20

Cable outlet

5734 80	45A - Cable Outlet - 2 Module	1274	5/50
5734 33	Cord Outlet - with 8mm Diameter - 1 Module	404	1/20/200
5734 79	Standard Cord Outlet - 2 Module	582	10/100

Blanking plate

5734 49	Blanking Plate - 1 Module	60	1/40/400
5723 44	Blanking Plate - 2 Module	88	1/10/100
5758 10	Blanking Plate with Frame - 2 Module	542	10/100

* MRP - Maximum Retail Price Inclusive of all taxes including GST.
 † To be Introduced Shortly
 (1) Supplied with white plate
 ■ Price available on request

Arteor™ square - white mechanism

Cat.Nos	Description	MRP* ₹ / Unit	Pack
---------	-------------	------------------	------

Mounting accessories for panel

5760 15	Panel Mounting Support - 1 Module	340	10/100
5760 16	Panel Mounting Support - 2 Module	358	10/100
5760 50	DIN Rail Support - 2 Module	426	10/100

Square - magnesium mechanism

Switches – 6A - 250V AC

5736 00	6A - Switch - SP - 1 Way - 1 Module	246	1/20/200
5736 01	6A - Switch - SP - 1 Way - with Indicator - 1 Module	426	1/20/200
5736 02	6A - Switch - SP - 2 Way - 1 Module	382	1/20/200
5736 03	6A - Switch - SP - 2 Way - with Indicator - 1 Module	544	1/20/200

Switches – 10A - 250V AC

5736 50	10A - Switch - SP - 1 Way - 2 Module	412	1/10/100
5736 51	10A - Switch - SP - 2 Way - 2 Module	486	1/10/100
5725 37	10A - Switch - SP - 2 Way - with Indicator & Label Holder - 2 Module	2366	5/50
5725 38	10A - Intermediate Switch - 250V AC - 2 Module	2976	10/100

Switches – 20A - 250V AC

5736 10	20A - Switch - SP - 1 Way - 1 Module	498	1/20/200
5736 52	20A - Switch - SP - 1 Way - 2 Module	588	1/10/100
5725 63	20A - Switch - SP - 1 Way - with Indicator - 1 Module	526	1/20/200
5736 11	20A - Switch - SP - 2 Way - with Indicator - 1 Module	718	1/20/200
5725 42	20A - Switch - SP - 2 Way - with Indicator - 2 Module	772	5/50
5725 43	20A - Switch - 3 Gang - 1 Way - 2 Module	1422	10/100
5725 44	20A - Switch - 3 Gang - 2*2 Way + 1*1 Way - 2 Module	1424	10/100
5736 54	20A - Switch - DP - 1 Way - with Indicator - 2 Module	1150	1/10/100
5725 49	20A - Switch - DP - 1 Way - with Indicator & Water Heater Marking - 2 Module	1228	10/100

Switches – 25A - 230V AC

5736 17	25A - Switch - 1 Way - with Indicator - 1 Module	660	1/20/200
---------	--	-----	----------

Bold Cat.Nos are products normally available with Legrand (India) Stockists. Cat.Nos that are not bold - delivery within 4 - 8 weeks from the date of order. Bold packing quantity is our mandatory packing. Orders to be placed by Legrand (India) Stockist in multiples of the same.

Arteor™ square - magnesium mechanism

Cat.Nos	Description	MRP* ₹ / Unit	Pack
---------	-------------	------------------	------

Switches – 32A - 250V AC

5736 12	32A - Switch - DP - 1 Way - with Indicator - 2 Module	1604	10/100
---------	---	------	--------



5736 12

Push button – 6A - 250V AC

5736 13	6A - Bell Push - SP - 1 Way - 1 Module	400	1/20/200
5736 59	6A - Bell Push - SP - 1 Way - 2 Module	572	1/10/100
5736 04	6A - Push Button - SP - 1 Way - 1 Module	414	1/20/200
5736 05	6A - Push Button - SP - 1 Way - with Indicator - 1 Module	554	1/20/200
5736 14	6A - Bell Push - SP - 1 Way - with Indicator - 1 Module	550	1/20/200
5736 60	6A - Bell Push - SP - 1 Way - with Indicator - 2 Module	768	1/10/100



5736 59



5736 14

Electric roller blinds control

5727 20	Double Switch for Electric Shutter - 2 Module	1006	10/100
---------	---	------	--------



5727 20

Dimmers and fan regulators

5736 62	Light Dimmer - 60 to 400 Watts - 2 Module	1616	1/10/100
5736 16	Fan Step Regulator - 100 Watts - ISI - 1 Module	1328	1/5/50
5736 63	Fan Step Regulator - 100 Watts - ISI - 2 Module	1636	1/10/100
5736 69	Fan Step Regulator - 120 Watts - ISI - 2 Module (for 48 & 56" Fans)	1750	1/10/100
5736 68	Fan Step Regulator - for Energy Saving Fans - 2 Module	1736	1/10/100
5736 56	Fan Regulator - 8 Step - 100 Watts - 2 Module	1552	10/100



5736 16



5736 69



5736 68

Indian standard sockets

5736 24	6A - Socket - with Shutter - 3 Pin - ISI - 2 Module	340	1/20/200
5736 71	6/16A - Socket - with Shutter - 3 Pin - Indian - ISI - 2 Module	670	1/10/100



5736 71

Arteor™ square - magnesium mechanism

Cat.Nos	Description	MRP* ₹ / Unit	Pack
---------	-------------	------------------	------

Indian standard sockets

5736 67	6/16A - Socket - with Shutter - 3 Pin - Indian - ISI - 3 Module	816	1/5/50
5737 10	16A - Socket Shutter with Switch - 3 Pin - 2P+E - Indian - 3 Module	1894	5/50
5736 66	25A - Socket - with Shutter - 2 Module	814	1/10/100



5736 67



5737 10

USB chargers (IS13252 (Part 1) / IEC 60950-1)

5734 44	USB Charger - 1500mA - Type A - 1 Module	2568	1/5/50
5736 36	USB Charger - 1500mA - Type C - 1 Module	2602	1/5/50
5716 81	USB Charger - 3000mA/15 Watts - Type A - 1 Module	2886	1/5/50
5716 85	USB Charger - 3000mA/15 Watts - Type A + A - 1 Module	3292	1/5/50
5716 89	USB Charger - 3000mA/15 Watts - Type A + C - 1 Module	3774	1/5/50
5716 93	USB Charger - 3000mA/15 Watts - Type C + C - 1 Module	4124	1/5/50
5716 97	USB Charger - Power Delivery - 20 Watts - Type C - 1 Module	5424	1/5/50
5734 82	USB Charger - Power Delivery - 30 Watts - Type C + C - 2 Module	7924	1/3/30
5754 82	USB Charger - Power Delivery - 45 Watts - Type C - 2 Module	10226	1/3/30
5754 91	USB Charger - Power Delivery - 63 Watts - Type C + C - 3 Module	12526	1/5/20



NEW!



NEW!



NEW!



NEW!



NEW!



NEW!



NEW!



5736 27



5736 28

Data and voice

5736 27	Telephone Socket - Double RJ11 - 1 Module	600	1/20/200
5736 26	Telephone Socket - RJ11 - with Shutter - 1 Module	362	1/20/200
5736 29	Information Socket - RJ45 - Cat 5E - UTP - 1 Module	735	1/20/200
5736 75	Information Socket - RJ45 - Cat 5E - UTP - 2 Module	837	1/10/100
5736 28	Information Socket - RJ45 - Cat 6 - UTP - 1 Module	1122	1/20/200
5736 74	Information Socket - RJ45 - Cat 6 - UTP - 2 Module	1182	1/10/100

* MRP - Maximum Retail Price Inclusive of all taxes including GST.
 ■ Price available on request

Bold Cat.Nos are products normally available with Legrand (India) Stockists. Cat.Nos that are not bold - delivery within 4 - 8 weeks from the date of order. Bold packing quantity is our mandatory packing. Orders to be placed by Legrand (India) Stockist in multiples of the same.

Arteor™

square - magnesium mechanism

Cat.Nos	Description	MRP* ₹ / Unit	Pack
---------	-------------	------------------	------

TV sockets

5736 25	TV Co - axial Socket - 1 Module	372	1/20/200
---------	---------------------------------	-----	----------

Electronic chime

5736 43	Bell Ding Dong - 230V - 2 Module	510	1/10/100
---------	----------------------------------	-----	----------

Buzzer

5736 42	Buzzer - 230V - 1 Module	1864	20/200
---------	--------------------------	------	--------

Bell call indicator & register - 6A - 250V AC

5736 15	6A - Bell Call Indicator - SP - with Register - 1 Way - 1 Module	2452	1/20/200
---------	--	------	----------

Lighting

5735 64	Skirting Light - with LED - 230V - 3 Module	1320	1/10/100
5727 26	Skirting Light - with Detector (LED) - 230V - 2 Module	20048	1/20

hospitality function

Hotel "DND and MMR " functions

5736 61	External DND & MMR Control Unit - with Bell Push - 2 Module	2620	1/5/50
5736 58	Internal DND & MMR Control Unit - 2 Module	1894	1/10/100

Hotel keycard switch

5727 44	15A - Key Card Switch - 230V - with Time Delay - 2 Module	6874	1/0/10
5727 59	Key Fob for Key Card Switch	2364	10/50

Shaver socket

5726 53	Shaver Socket - 120/230V - with Earth Connector	7146	1
---------	---	------	---

Time switch

5740 84	Time Delay Switch - 2 Module	8950	1/20
---------	------------------------------	------	------

Audio - video connector

5727 72	Double RCA Socket (Audio) - 1 Module	5974	1/20
5727 73	Triple RCA Socket (Audio & Video) - 1 Module	4660	1/20
5727 74	Female 3.5mm Jack - 1 Module	5300	1/20
5727 76	Female BNC 75 Jack - 1 Module	5156	1/20

* MRP - Maximum Retail Price Inclusive of all taxes including GST.

■ To be Introduced Shortly

(1) Supplied with white plate

■ Price available on request

Arteor™

square - magnesium mechanism

Cat.Nos	Description	MRP* ₹ / Unit	Pack
---------	-------------	------------------	------

Audio - video connector

5727 83	Female XLR Jack - 2 Module	9272	1/20
5725 97	Preterminated Sockets Female Hd15 - 1 Module	7311	1
5725 96	Preterminated HDMI Socket - 1.4 - 1 Module	8287	1
5727 84	Line Dying Down - 100V (25 - 30W) - 2 Module	14841	1
5727 75	USB Socket - 1 Module	4143	1/20
5727 88	Female HD15 + Jack 3.5mm - 2 Module	5818	1/20

Blanking plate

5736 49	Blanking Plate - 1 Module	60	1/40/400
5728 44	Blanking Plate - 2 Module	100	1/10/100

Dedicated switches

5738 02	20A - Dedicated Switch - DP - 1 Way - 1 Module - Red	1156	5/40
---------	--	------	------

Tamper proof and dedicated sockets

5738 10	16A - Dedicated Socket with Switch - 3 Pin - 2P+E - Indian - 3 Module	2322	5/50
---------	---	------	------

square - champagne mechanism

Switches – 6A - 250V AC

5748 00	6A - Switch - SP - 1 Way - 1 Module	246	1/20/200
5748 01	6A - Switch - SP - 1 Way - with Indicator - 1 Module	426	1/20/200
5748 02	6A - Switch - SP - 2 Way - 1 Module	382	1/20/200
5748 03	6A - Switch - SP - 2 Way - with Indicator - 1 Module	544	1/20/200

Switches – 10A - 250V AC

5748 04	10A - Switch - SP - 1 Way - 2 Module	412	1/10/100
5748 05	10A - Switch - SP - 2 Way - 2 Module	486	1/10/100
5748 06	10A - Switch - SP - 2 Way - with Indicator & Label Holder - 2 Module	2434	1/10/100
5748 07	10A - Intermediate Switch - 250V AC - 2 Module	2976	1/10/100

Bold Cat.Nos are products normally available with Legrand (India) Stockists. Cat.Nos that are not bold - delivery within 4 - 8 weeks from the date of order. Bold packing quantity is our mandatory packing. Orders to be placed by Legrand (India) Stockist in multiples of the same.

Arteor™ square - champagne mechanism

Cat.Nos	Description	MRP* ₹ / Unit	Pack
---------	-------------	------------------	------

Switches – 20A - 250V AC

5748 08	20A - Switch - SP - 1 Way - 1 Module	498	1/20/200
5748 09	20A - Switch - SP - 1 Way - 2 Module	588	1/10/100
5748 10	20A - Switch - SP - 1 Way - with Indicator - 1 Module	526	1/20/200
5748 11	20A - Switch - SP - 2 Way - with Indicator - 1 Module	718	1/20/200
5748 12	20A - Switch - SP - 2 Way - with Indicator - 2 Module	770	1/10/100
5748 13	20A - Switch - 3 Gang - 1 Way - 2 Module	1422	1/10/100
5748 14	20A - Switch - 3 Gang - 2*2 Way + 1*1 Way - 2 Module	1486	1/10/100
5748 15	20A - Switch - DP - 1 Way - with Indicator - 2 Module	1150	1/10/100
5748 16	20A - Switch - DP - 1 Way - with Indicator & Water Heater Marking - 2 Module	1228	1/10/100

Switches – 25A - 230V AC

5748 17	25A - Switch - 1 Way - with Indicator - 1 Module	660	1/20/200
---------	--	-----	----------

Switches – 32A / 40A - 250V AC

5748 18	32A - Switch - DP - 1 Way - with Indicator - 2 Module	1604	1/10/100
5748 19	40A - Switch - DP - 1 Way - with Indicator - fits on 1/2 Module Box	1846	1/5/20

Push button – 6A - 250V AC

5748 23	6A - Bell Push - SP - 1 Way - 1 Module	400	1/20/200
5748 24	6A - Bell Push - SP - 1 Way - 2 Module	572	1/10/100
5748 21	6A - Push Button - SP - 1 Way - 1 Module	414	20/200
5748 22	6A - Push Button - SP - 1 Way - with Indicator - 1 Module	554	20/200
5748 25	6A - Bell Push - SP - 1 Way - with Indicator - 1 Module	550	1/20/200
5748 26	6A - Bell Push - SP - 1 Way - with Indicator - 2 Module	768	1/10/100

Electric roller blinds control

5748 20	Double Switch for Electric Shutter - 2 Module	1006	1/10/100
---------	---	------	----------

Dimmers and fan regulators

5748 27	Light Dimmer - 60 To 400 Watts - 2 Module	1660	10/100
5748 29	Fan Step Regulator - 100 Watts - ISI - 1 Module	1328	1/5/50
5748 30	Fan Step Regulator - 100 Watts - ISI - 2 Module	1636	1/10/100
5748 31	Fan Step Regulator - 120 Watts - ISI - 2 Module (for 48 & 56" Fans)	1750	1/10/100

* MRP - Maximum Retail Price Inclusive of all taxes including GST.
Red Cat.Nos - new products
■ Price available on request.

Arteor™ square - champagne mechanism

Cat.Nos	Description	MRP* ₹ / Unit	Pack
---------	-------------	------------------	------

5748 32	Fan Step Regulator - for Energy Saving Fans - 2 Module	1736	1/10/100
5736 57	Fan Regulator - 8 Step - 100 Watts - 2 Module	1552	10/100

Indian standard sockets

5748 84	6A - Socket - with Shutter - 3 Pin - ISI - 2 Module	340	1/20/200
5748 34	6/16A - Socket - with Shutter - 3 Pin - Indian - ISI - 2 Module	670	1/10/100
5748 35	6/16A - Socket - with Shutter - 3 Pin - Indian - ISI - 3 Module	816	1/5/50
5748 41	25A - Socket - with Shutter - 2 Module	814	1/10/100

USB chargers (IS13252 (part 1) / IEC 60950-1)

5734 47	USB Charger - 1500mA - Type A - 1 Module	2568	1/5/50
5748 66	USB Charger - 1500mA - Type C - 1 Module	2602	1/5/50
5716 82	USB Charger - 3000mA/15 Watts - Type A - 1 Module	2886	1/5/50
5716 86	USB Charger - 3000mA/15 Watts - Type A + A - 1 Module	3292	1/5/50
5716 90	USB Charger - 3000mA/15 Watts - Type A + C - 1 Module	3774	1/5/50
5716 94	USB Charger - 3000mA/15 Watts - Type C + C - 1 Module	4124	1/5/50
5716 98	USB Charger - Power Delivery - 20 Watts - Type C - 1 Module	5424	1/5/50
5734 83	USB Charger - Power Delivery - 30 Watts - Type C + C - 2 Module	7924	1/3/30
5754 83	USB Charger - Power Delivery - 45 Watts - Type C - 2 Module	10226	1/3/30
5754 92	USB Charger - Power Delivery - 63 Watts - Type C + C - 3 Module	12526	1/5/20

Data and voice

5748 45	Telephone Socket - Double RJ11 - 1 Module	600	20/200
5748 46	Telephone Socket - RJ11 - with Shutter - 1 Module	362	20/200
5748 47	Information Socket - RJ45 - Cat 5E - UTP - 1 Module	735	20/200
5748 48	Information Socket - RJ45 - Cat 5E - UTP - 2 Module	790	20/200
5748 49	Information Socket - RJ45 - Cat 6 - UTP - 1 Module	1122	1/20/200
5748 50	Information Socket - RJ45 - Cat 6 - UTP - 2 Module	1182	1/10/100

Bold Cat.Nos are products normally available with Legrand (India) Stockists. Cat.Nos that are not bold - delivery within 4 - 8 weeks from the date of order. Bold packing quantity is our mandatory packing. Orders to be placed by Legrand (India) Stockist in multiples of the same.

Arteor™ square - champagne mechanism

Cat.Nos	Description	MRP* ₹ / Unit	Pack
---------	-------------	------------------	------

TV sockets

5748 51	TV Co - axial Socket - 1 Module	372	1/20/200
---------	---------------------------------	-----	----------

Electronic chime

5748 52	Bell Ding Dong - 230V - 2 Module	510	1/10/100
---------	----------------------------------	-----	----------

Buzzer

5748 53	Buzzer - 230V - 1 Module	1864	20/200
---------	--------------------------	------	--------

Bell call indicator & register - 6A - 250V AC

5748 54	6A - Bell Call Indicator - SP - with Register - 1 Way - 1 Module	2452	20/200
---------	--	------	--------

Lighting

5748 55	Skirting Light - with LED - 230V - 3 Module	1320	10/100
---------	---	------	--------

hospitality function

Hotel "DND and MMR" functions

5748 56	External DND & MMR Control Unit - with Bell Push - 2 Module	2620	1/5/50
5748 57	Internal DND & MMR Control Unit - 2 Module	1894	1/10/100

Hotel keycard switch

5748 58	15A - Key Card Switch - 230V - with Time Delay - 2 Module	6776	1/0/10
5727 59	Key Fob for Key Card Switch	2364	10/50

Blanking plate

5748 63	Blanking Plate - 1 Module	60	1/40/400
5748 64	Blanking Plate - 2 Module	100	1/10/100

Round - white mechanism

Switches - 6A - 250V AC

5733 00	6A - Switch - SP - 1 Way - Left - 1 Module	316	1/20/200
5733 01	6A - Switch - SP - 1 Way - Right - 1 Module	316	1/20/200
5733 12	6A - Switch - SP - 1 Way - Middle - 1 Module	316	1/20/200
5733 05	6A - Switch - SP - 2 Way - Left - 1 Module	394	1/20/200
5733 06	6A - Switch - SP - 2 Way - Right - 1 Module	394	1/20/200
5733 02	6A - Switch - SP - 1 Way - with Indicator - Left - 1 Module	450	1/20/200
5733 04	6A - Switch - SP - 1 Way - with Indicator - Right - 1 Module	450	1/20/200
5733 03	6A - Switch - SP - 1 Way - with Indicator - Middle - 1 Module	450	1/20/200
5733 07	6A - Switch - SP - 2 Way - with Indicator - Left - 1 Module	564	1/20/200
5733 08	6A - Switch - SP - 2 Way - with Indicator - Right - 1 Module	564	1/20/200

Arteor™ round - white mechanism

Cat.Nos	Description	MRP* ₹ / Unit	Pack
---------	-------------	------------------	------

Switches - 20A - 250V AC

5733 20	20A - Switch - SP - 1 Way - Left - 1 Module	532	1/20/200
5733 21	20A - Switch - SP - 1 Way - Right - 1 Module	532	1/20/200
5730 21	20A - Switch - SP - 1 Way - Middle - 1 Module	542	10/100
5733 40	20A - Switch - SP - 1 Way - 2 Module	618	1/10/100
5720 64	20A - Switch - SP - 1 Way - with Indicator - Left - 1 Module	548	1/20/200
5720 65	20A - Switch - SP - 1 Way - with Indicator - Right - 1 Module	548	1/20/200
5730 24	20A - Switch - SP - 2 Way - Middle - 1 Module	550	10/100
5733 22	20A - Switch - SP - 2 Way - with Indicator - Left - 1 Module	758	1/20/200
5733 23	20A - Switch - SP - 2 Way - with Indicator - Right - 1 Module	758	1/20/200
5730 71	20A - Switch - SP - 2 Way - with Indicator - 2 Module	674	5/50
5730 72	20A - Switch - 3 Gang - 1 Way - 2 Module	1486	10/100
5730 73	20A - Switch - 3 Gang - 2*2 Way + 1*1 Way - 2 Module	1658	10/100
5733 42	20A - Switch - DP - 1 Way - with Indicator - 2 Module	1150	1/10/100

Switches - 32A - 230V AC

5733 26	32A - Switch - DP - 1 Way - with Indicator - 2 Module	1676	10/100
---------	---	------	--------

Push button - 6A - 250V AC

5733 31	6A - Bell Push - SP - 1 Way - Right - 1 Module	414	1/20/200
5733 30	6A - Bell Push - SP - 1 Way - Left - 1 Module	414	1/20/200
5733 46	6A - Bell Push - SP - 1 Way - 2 Module	590	1/10/100
5733 47	6A - Bell Push - SP - 1 Way - with Indicator - 2 Module	800	1/10/100

Electronic roller blinds control

5732 20	Double Switch For Electric Shutter - 2 Module	1066	10/100
---------	---	------	--------

Dimmers and fan regulators

5730 66	Light Dimmer - 60 To 400 Watts - 2 Module	1682	1/10/100
5730 03	Fan Step Regulator - 100 Watts - ISI - 2 Module	1706	1/10/100
5730 69	Fan Step Regulator - 120 Watts - ISI - 2 Module	1848	1/10/100
5730 04	Fan Step Regulator - for Energy Saving Fans - 2 Module	1810	10/100

* MRP - Maximum Retail Price Inclusive of all taxes including GST.

■ To be Introduced Shortly

Red Cat.Nos - new products

(1) Supplied with white plate

■ Price available on request

Bold Cat.Nos are products normally available with Legrand (India) Stockists. Cat.Nos that are not bold - delivery within 4 - 8 weeks from the date of order. Bold packing quantity is our mandatory packing. Orders to be placed by Legrand (India) Stockist in multiples of the same.

Arteor™ round - white mechanism

Cat.Nos	Description	MRP* ₹ / Unit	Pack
---------	-------------	------------------	------

NEW!

Indian standard sockets

5734 94	6A - Socket - with Shutter - 3 Pin - ISI - 2 Module	606	20/200
---------	---	-----	--------

Data and voice

5723 24	Information Socket - RJ45 - Cat 6 - UTP - 2 Module	1314	10/100
---------	--	------	--------

Hotel "DND and MMR" functions

5720 74	Internal DND & MMR Control Unit - 2 Module	2294	5/50
5720 67	External DND & MMR Control Unit - with Bell Push - 2 Module	2882	5/40

Blanking plate

5730 87	Blanking Plate - 2 Module	102	1/10/100
---------	---------------------------	-----	----------

Round - magnesium mechanism

Switches - 6A - 250V AC

5733 50	6A - Switch - SP - 1 Way - Left - 1 Module	364	1/20/200
5733 51	6A - Switch - SP - 1 Way - Right - 1 Module	364	1/20/200
5733 62	6A - Switch - SP - 1 Way - Middle - 1 Module	366	1/20/200
5733 55	6A - Switch - SP - 2 Way - Left - 1 Module	456	1/20/200
5733 56	6A - Switch - SP - 2 Way - Right - 1 Module	456	1/20/200
5733 52	6A - Switch - SP - 1 Way - with Indicator - Left - 1 Module	504	1/20/200
5733 54	6A - Switch - SP - 1 Way - with Indicator - Right - 1 Module	504	1/20/200
5733 57	6A - Switch - SP - 2 Way - with Indicator - Left - 1 Module	652	1/20/200
5733 58	6A - Switch - SP - 2 Way - with Indicator - Right - 1 Module	652	1/20/200

Switches - 20A - 250V AC

5733 70	20A - Switch - SP - 1 Way - Left - 1 Module	592	1/20/200
5733 71	20A - Switch - SP - 1 Way - Right - 1 Module	592	1/20/200
5731 21	20A - Switch - SP - 1 Way - Middle - 1 Module	576	10/100
5733 90	20A - Switch - SP - 1 Way - 2 Module	702	1/10/100
5725 64	20A - Switch - SP - 1 Way - with Indicator - Left - 1 Module	618	1/20/200

* MRP - Maximum Retail Price Inclusive of all taxes including GST.
■ Price available on request.

Arteor™ round - magnesium mechanism

Cat.Nos	Description	MRP* ₹ / Unit	Pack
---------	-------------	------------------	------

Switches - 20A - 250V AC

5725 65	20A - Switch - SP - 1 Way - with Indicator - Right - 1 Module	618	1/20/200
5731 24	20A - Switch - SP - 2 Way - Middle - 1 Module	608	10/100
5733 72	20A - Switch - SP - 2 Way - with Indicator - Left - 1 Module	860	1/20/200
5733 73	20A - Switch - SP - 2 Way - with Indicator - Right - 1 Module	860	1/20/200
5731 71	20A - Switch - SP - 2 Way - with Indicator - 2 Module	816	5/50
5731 72	20A - Switch - 3 Gang - 1 Way - 2 Module	1704	5/50
5731 73	20A - Switch - 3 Gang - 2*2 Way + 1*1 Way - 2 Module	1720	10/100
5733 92	20A - Switch - DP - 1 Way - with Indicator - 2 Module	1332	1/10/100
5731 27	20A - Switch - SP - 2 Way - with Indicator - Middle - 1 Module	826	20/200

Switches - 32A - 230V AC

5733 76	32A - Switch - DP - 1 Way - with Indicator - 2 Module	1920	10/100
---------	---	------	--------

Push button - 6A - 250V AC

5733 81	6A - Bell Push - SP - 1 Way - Right - 1 Module	486	1/20/200
5733 80	6A - Bell Push - SP - 1 Way - Left - 1 Module	486	1/20/200
5733 96	6A - Bell Push - SP - 1 Way - 2 Module	690	1/10/100
5733 97	6A - Bell Push - SP - 1 Way - with Indicator - 2 Module	908	1/10/100

Electronic roller blinds control

5737 20	Double Switch for Electric Shutter - 2 Module	1180	10/100
---------	---	------	--------

Dimmers and fan regulators

5733 66	Light Dimmer - 60 To 400 Watts - 2 Module	1950	1/10/100
5731 03	Fan Step Regulator - 100 Watts - ISI - 2 Module	1962	1/10/100
5731 69	Fan Step Regulator - 120 Watts - ISI - 2 Module	2114	1/10/100
5731 04	Fan Step Regulator - for Energy Saving Fans - 2 Module	2090	10/100

NEW!

Indian standard sockets

5736 94	6A - Socket - with Shutter - 3 Pin - ISI - 2 Module	702	20/200
---------	---	-----	--------

Data and voice

5728 24	Information Socket - RJ45 - Cat 6 - UTP - 2 Module	1502	10/100
---------	--	------	--------

Hotel "DND and MMR" functions

5725 74	Internal DND & MMR Control Unit - 2 Module	2630	5/50
---------	--	------	------

Bold Cat.Nos are products normally available with Legrand (India) Stockists. Cat.Nos that are not bold - delivery within 4 - 8 weeks from the date of order. Bold packing quantity is our mandatory packing. Orders to be placed by Legrand (India) Stockist in multiples of the same.

Arteor™

round - magnesium mechanism

Cat.Nos	Description	MRP* ₹ / Unit	Pack
---------	-------------	------------------	------

Hotel "DND and MMR" functions

5725 67	External DND & MMR Control Unit - with Bell Push - 2 Module	3148	5/40
---------	---	------	------

Blanking plate

5731 87	Blanking Plate - 2 Module	118	1/10/100
---------	---------------------------	-----	----------

Round - champagne mechanism

Switches - 6A - 250V AC

5749 00	6A - Switch - SP - 1 Way - Left - 1 Module	364	20/200
5749 01	6A - Switch - SP - 1 Way - Right - 1 Module	364	20/200
5749 02	6A - Switch - SP - 1 Way - Middle - 1 Module	364	20/200
5749 03	6A - Switch - SP - 2 Way - Left - 1 Module	456	20/200
5749 04	6A - Switch - SP - 2 Way - Right - 1 Module	456	20/200
5749 05	6A - Switch - SP - 1 Way - with Indicator - Left - 1 Module	504	20/200
5749 06	6A - Switch - SP - 1 Way - with Indicator - Right - 1 Module	504	20/200
5749 07	6A - Switch - SP - 1 Way - with Indicator - Middle - 1 Module	504	20/200
5749 08	6A - Switch - SP - 2 Way - with Indicator - Left - 1 Module	652	20/200
5749 09	6A - Switch - SP - 2 Way - with Indicator - Right - 1 Module	652	20/200

Switches - 20A - 250V AC

5749 10	20A - Switch - SP - 1 Way - Left - 1 Module	592	20/200
5749 11	20A - Switch - SP - 1 Way - Right - 1 Module	592	20/200
5749 12	20A - Switch - SP - 1 Way - Middle - 1 Module	592	20/200
5749 13	20A - Switch - SP - 1 Way - 2 Module	702	10/100
5749 14	20A - Switch - SP - 1 Way - with Indicator - Left - 1 Module	618	20/200
5749 15	20A - Switch - SP - 1 Way - with Indicator - Right - 1 Module	618	20/200
5749 16	20A - Switch - SP - 2 Way - Middle - 1 Module	626	20/200
5749 17	20A - Switch - SP - 2 Way - with Indicator - Left - 1 Module	862	20/200
5749 18	20A - Switch - SP - 2 Way - with Indicator - Right - 1 Module	862	20/200
5749 19	20A - Switch - SP - 2 Way - with Indicator - 2 Module	816	10/100
5749 20	20A - Switch - 3 Gang - 1 Way - 2 Module	1704	10/100
5749 21	20A - Switch - 3 Gang - 2*2 Way + 1*1 Way - 2 Module	1798	10/100
5749 22	20A - Switch - DP - 1 Way - with Indicator - 2 Module	1332	10/100

* MRP - Maximum Retail Price Inclusive of all taxes including GST.

Red Cat.Nos - new products

■ Price available on request.

Arteor™

round - champagne mechanism

Cat.Nos	Description	MRP* ₹ / Unit	Pack
---------	-------------	------------------	------

Push button - 6A - 250V AC

5749 23	6A - Bell Push - SP - 1 Way - Right - 1 Module	486	20/200
5749 24	6A - Bell Push - SP - 1 Way - Left - 1 Module	486	20/200
5749 25	6A - Bell Push - SP - 1 Way - 2 Module	690	10/100
5749 26	6A - Bell Push - SP - 1 Way - with Indicator - 2 Module	908	10/100

Dimmers and fan regulators

5749 27	Light Dimmer - 60 To 400 Watts - 2 Module	2012	10/100
5749 29	Fan Step Regulator - 100 Watts - ISI - 2 Module	1962	10/100
5749 30	Fan Step Regulator - 120 Watts - ISI - 2 Module	2114	10/100
5749 31	Fan Step Regulator - for Energy Saving Fans - 2 Module	2090	10/100

Indian standard sockets

5749 94	6A - Socket - with Shutter - 3 Pin - ISI - 2 Module	702	20/200
---------	---	-----	--------

Blanking plate

5749 64	Blanking Plate - 2 Module	118	10/100
---------	---------------------------	-----	--------

square cover plates with metal frame

White cover plates with metal frame

5757 00	Cover Plate - 1 Module - White	260	10/100
5757 10	Cover Plate - 2 Module - White	274	10/100
5757 20	Cover Plate - 3 Module - White	306	10/100
5757 30	Cover Plate - 4 Module - White	320	5/50
5757 40	Cover Plate - 6 Module - White	588	5/30
5757 50	Cover Plate - 8 Module - White	652	5/30
5757 60	Cover Plate - 2*4 Module - White	822	2/20
5757 70	Cover Plate - 2*6 Module - White	1004	2/16
5757 80	Cover Plate - 2*8 Module - White	1206	2/16
5757 90	Cover Plate - 3*6 Module - White	1334	2/12
5758 00	Cover Plate - 3*8 Module - White	1594	2/12
5750 70	Cover Plate - for Shaver Socket-3 Module - White	466	5/50

Pearl aluminium cover plates with Metal frame

5759 73	Cover Plate - 1 Module - Pearl Aluminium	388	10/100
5759 74	Cover Plate - 2 Module - Pearl Aluminium	402	1/10/100
5759 75	Cover Plate - 3 Module - Pearl Aluminium	436	10/100
5759 76	Cover Plate - 4 Module - Pearl Aluminium	494	5/50
5759 77	Cover Plate - 6 Module - Pearl Aluminium	850	5/30
5759 78	Cover Plate - 8 Module - Pearl Aluminium	932	1/5/30
5759 79	Cover Plate - 2*4 Module - Pearl Aluminium	1186	2/20
5759 80	Cover Plate - 2*6 Module - Pearl Aluminium	1540	1/2/16
5759 81	Cover Plate - 2*8 Module - Pearl Aluminium	1742	2/16
5759 82	Cover Plate - 3*6 Module - Pearl Aluminium	2036	2/12
5759 83	Cover Plate - 3*8 Module - Pearl Aluminium	2320	2/12

Bold Cat.Nos are products normally available with Legrand (India) Stockists. Cat.Nos that are not bold - delivery within 4 - 8 weeks from the date of order. Bold packing quantity is our mandatory packing. Orders to be placed by Legrand (India) Stockist in multiples of the same.

Arteor™

square cover plates with metal frame

Cat.Nos	Description	MRP* ₹ / Unit	Pack
---------	-------------	------------------	------

Graphite cover plates with metal frame

5759 61	Cover Plate - 1 Module - Graphite	388	10/100
5759 62	Cover Plate - 2 Module - Graphite	402	1/10/100
5759 63	Cover Plate - 3 Module - Graphite	436	10/100
5759 64	Cover Plate - 4 Module - Graphite	494	5/50
5759 66	Cover Plate - 6 Module - Graphite	850	5/30
5759 67	Cover Plate - 8 Module - Graphite	932	1/5/30
5759 68	Cover Plate - 2*4 Module - Graphite	1186	2/20
5759 69	Cover Plate - 2*6 Module - Graphite	1540	1/2/16
5759 70	Cover Plate - 2*8 Module - Graphite	1742	2/16
5759 71	Cover Plate - 3*6 Module - Graphite	2036	2/12
5759 72	Cover Plate - 3*8 Module - Graphite	2320	2/12

Magnesium cover plates with metal frame

5755 89	Cover Plate - 1 Module - Magnesium	388	10/100
5755 90	Cover Plate - 2 Module - Magnesium	402	1/10/100
5755 91	Cover Plate - 3 Module - Magnesium	436	10/100
5755 93	Cover Plate - 4 Module - Magnesium	494	5/50
5755 94	Cover Plate - 6 Module - Magnesium	850	5/50
5755 95	Cover Plate - 8 Module - Magnesium	932	1/5/30
5755 96	Cover Plate - 2*4 Module - Magnesium	1186	5/20
5755 97	Cover Plate - 2*6 Module - Magnesium	1540	1/2/16
5755 98	Cover Plate - 2*8 Module - Magnesium	1742	2/16
5755 99	Cover Plate - 3*6 Module - Magnesium	2036	2/12

Champagne cover plates with metal frame

5759 84	Cover Plate - 1 Module - Champagne	388	10/100
5759 85	Cover Plate - 2 Module - Champagne	402	1/10/100
5759 86	Cover Plate - 3 Module - Champagne	436	10/100
5759 87	Cover Plate - 4 Module - Champagne	494	5/50
5759 88	Cover Plate - 6 Module - Champagne	850	5/30
5759 89	Cover Plate - 8 Module - Champagne	932	1/5/30
5759 90	Cover Plate - 2*4 Module - Champagne	1186	2/20
5759 91	Cover Plate - 2*6 Module - Champagne	1540	1/2/16
5759 92	Cover Plate - 2*8 Module - Champagne	1742	2/16
5759 93	Cover Plate - 3*6 Module - Champagne	2036	2/12



5757 21



5757 61



5757 22



5757 42

Arteor™

square cover plates with metal frame

Cat.Nos	Description	MRP* ₹ / Unit	Pack
---------	-------------	------------------	------

Dark bronze cover plates with metal frame

5756 79	Cover Plate - 1 Module - Dark Bronze	388	10/100
5756 80	Cover Plate - 2 Module - Dark Bronze	402	1/10/100
5756 81	Cover Plate - 3 Module - Dark Bronze	436	10/100
5756 83	Cover Plate - 4 Module - Dark Bronze	494	5/50
5756 84	Cover Plate - 6 Module - Dark Bronze	850	5/30
5756 85	Cover Plate - 8 Module - Dark Bronze	932	1/5/30
5756 86	Cover Plate - 2*4 Module - Dark Bronze	1186	2/20
5756 87	Cover Plate - 2*6 Module - Dark Bronze	1540	1/2/16
5756 88	Cover Plate - 2*8 Module - Dark Bronze	1742	2/16
5756 89	Cover Plate - 3*6 Module - Dark Bronze	2036	2/12

Pearl aluminium cover plates with overmoulded frame

5757 01	Cover Plate - 1 Module - Pearl Aluminium	430	10/100
5757 11	Cover Plate - 2 Module - Pearl Aluminium	454	10/100
5757 21	Cover Plate - 3 Module - Pearl Aluminium	486	10/100
5757 31	Cover Plate - 4 Module - Pearl Aluminium	548	5/50
5757 41	Cover Plate - 6 Module - Pearl Aluminium	934	5/30
5757 51	Cover Plate - 8 Module - Pearl Aluminium	1036	5/30
5757 61	Cover Plate - 2*4 Module - Pearl Aluminium	1314	2/20
5757 71	Cover Plate - 2*6 Module - Pearl Aluminium	1708	2/16
5757 81	Cover Plate - 2*8 Module - Pearl Aluminium	1940	2/16
5757 91	Cover Plate - 3*6 Module - Pearl Aluminium	2268	2/12
5758 01	Cover Plate - 3*8 Module - Pearl Aluminium	2574	2/12
5750 71	Cover Plate - for Shaver Socket-3 Module - Pearl Aluminium	736	5/50

Graphite cover plates with overmoulded frame

5757 02	Cover Plate - 1 Module - Graphite	430	10/100
5757 12	Cover Plate - 2 Module - Graphite	454	10/100
5757 22	Cover Plate - 3 Module - Graphite	486	10/100
5757 32	Cover Plate - 4 Module - Graphite	548	5/50
5757 42	Cover Plate - 6 Module - Graphite	934	5/30
5757 52	Cover Plate - 8 Module - Graphite	1036	5/30
5757 62	Cover Plate - 2*4 Module - Graphite	1314	2/20
5757 72	Cover Plate - 2*6 Module - Graphite	1708	2/16
5757 82	Cover Plate - 2*8 Module - Graphite	1940	2/16
5757 92	Cover Plate - 3*6 Module - Graphite	2268	2/12
5758 02	Cover Plate - 3*8 Module - Graphite	2576	2/12
5750 72	Cover Plate - for Shaver Socket-3 Module - Graphite	736	5/50

* MRP - Maximum Retail Price Inclusive of all taxes including GST.
Red Cat.Nos - new products

Bold Cat.Nos are products normally available with Legrand (India) Stockists. Cat.Nos that are not bold - delivery within 4 - 8 weeks from the date of order. Bold packing quantity is our mandatory packing. Orders to be placed by Legrand (India) Stockist in multiples of the same.

Arteor™

square cover plates with metal frame

Cat.Nos	Description	MRP* ₹ / Unit	Pack
---------	-------------	------------------	------

Magnesium cover plates with overmoulded frame

5758 11	Cover Plate - 1 Module - Magnesium	430	10/100
5758 12	Cover Plate - 2 Module - Magnesium	454	10/100
5758 13	Cover Plate - 3 Module - Magnesium	486	10/100
5758 14	Cover Plate - 4 Module - Magnesium	548	5/30
5758 15	Cover Plate - 6 Module - Magnesium	934	5/30
5758 16	Cover Plate - 8 Module - Magnesium	1036	5/30
5758 17	Cover Plate - 2*4 Module - Magnesium	1314	2/20
5758 18	Cover Plate - 2*6 Module - Magnesium	1708	2/16
5758 19	Cover Plate - 2*8 Module - Magnesium	1940	2/16
5758 20	Cover Plate - 3*6 Module - Magnesium	2268	2/12
5758 21	Cover Plate - for Shaver Socket-3 Module - Magnesium	736	5/50

Champagne cover plates with overmoulded frame

5758 22	Cover Plate - 1 Module - Champagne	430	10/100
5758 23	Cover Plate - 2 Module - Champagne	454	10/100
5758 24	Cover Plate - 3 Module - Champagne	486	10/100
5758 25	Cover Plate - 4 Module - Champagne	548	5/50
5758 26	Cover Plate - 6 Module - Champagne	934	5/30
5758 27	Cover Plate - 8 Module - Champagne	1036	5/30
5758 28	Cover Plate - 2*4 Module - Champagne	1314	2/20
5758 29	Cover Plate - 2*6 Module - Champagne	1708	2/16
5758 30	Cover Plate - 2*8 Module - Champagne	1940	2/16
5758 31	Cover Plate - 3*6 Module - Champagne	2268	2/12
5758 32	Cover Plate - for Shaver Socket-3 Module - Champagne	736	5/50

Dark bronze cover plates with overmoulded frame

5758 33	Cover Plate - 1 Module - Dark Bronze	430	10/100
5758 34	Cover Plate - 2 Module - Dark Bronze	454	10/100
5758 35	Cover Plate - 3 Module - Dark Bronze	486	10/100
5758 36	Cover Plate - 4 Module - Dark Bronze	548	5/50
5758 37	Cover Plate - 6 Module - Dark Bronze	934	5/30
5758 38	Cover Plate - 8 Module - Dark Bronze	1036	5/30
5758 39	Cover Plate - 2*4 Module - Dark Bronze	1314	2/20
5758 40	Cover Plate - 2*6 Module - Dark Bronze	1708	2/16
5758 41	Cover Plate - 2*8 Module - Dark Bronze	1940	2/16
5758 42	Cover Plate - 3*6 Module - Dark Bronze	2268	2/12
5758 43	Cover Plate - for Shaver Socket-3 Module - Dark Bronze	736	5/50

Arteor™

square cover plates

Cat.Nos	Description	MRP* ₹ / Unit	Pack
---------	-------------	------------------	------

Mirror black cover plates with overmoulded frame

5757 03	Cover Plate - 1 Module - Mirror Black	2140	1/5/30
5757 13	Cover Plate - 2 Module - Mirror Black	2286	1/5/30
5757 23	Cover Plate - 3 Module - Mirror Black	2450	1/20
5757 33	Cover Plate - 4 Module - Mirror Black	2604	1/20
5757 43	Cover Plate - 6 Module - Mirror Black	4738	1/5
5757 53	Cover Plate - 8 Module - Mirror Black	5218	1/5
5757 63	Cover Plate - 2*4 Module - Mirror Black	6614	1/10
5757 73	Cover Plate - 2*6 Module - Mirror Black	8138	1/8

Mirror white cover plates with overmoulded frame

5757 04	Cover Plate - 1 Module - Mirror White	2140	1/5/30
5757 14	Cover Plate - 2 Module - Mirror White	2286	1/5/30
5757 24	Cover Plate - 3 Module - Mirror White	2450	1/20
5757 34	Cover Plate - 4 Module - Mirror White	2604	1/20
5757 44	Cover Plate - 6 Module - Mirror White	4738	1/5
5757 54	Cover Plate - 8 Module - Mirror White	5218	1/5
5757 64	Cover Plate - 2*4 Module - Mirror White	6736	1/10
5757 74	Cover Plate - 2*6 Module - Mirror White	8138	1/8

Mirror green apple cover plates with overmoulded frame

5758 44	Cover Plate - 1 Module - Green Apple	2140	1/5/30
5758 45	Cover Plate - 2 Module - Green Apple	2286	1/5/30
5758 46	Cover Plate - 3 Module - Green Apple	2450	1/20
5758 47	Cover Plate - 4 Module - Green Apple	2604	1/20
5758 48	Cover Plate - 6 Module - Green Apple	4738	1/5
5758 49	Cover Plate - 8 Module - Green Apple	5218	1/5
5758 50	Cover Plate - 2*4 Module - Green Apple	6734	1/10
5758 51	Cover Plate - 2*6 Module - Green Apple	8138	1/8
5758 52	Cover Plate - for Shaver Socket-3 Module - Green Apple	3568	1/5/50

* MRP - Maximum Retail Price Inclusive of all taxes including GST.
Red Cat.Nos - new products

Bold Cat.Nos are products normally available with Legrand (India) Stockists. Cat.Nos that are not bold - delivery within 4 - 8 weeks from the date of order. Bold packing quantity is our mandatory packing. Orders to be placed by Legrand (India) Stockist in multiples of the same.

Arteor™ square cover plates

Cat.Nos	Description	MRP* ₹ / Unit	Pack
---------	-------------	------------------	------

Graphic casual cover plates with overmoulded frame

5762 91	Cover Plate - 1 Module - Graphic Casual	2598	1/5/30
5763 11	Cover Plate - 2 Module - Graphic Casual	2794	1/5/30
5763 31	Cover Plate - 3 Module - Graphic Casual	3002	1/20
5763 51	Cover Plate - 4 Module - Graphic Casual	3204	1/20
5763 81	Cover Plate - 6 Module - Graphic Casual	5800	1/5
5764 01	Cover Plate - 8 Module - Graphic Casual	6398	1/5
5758 89	Cover Plate - 2*4 Module - Graphic Casual	8054	1/10
5758 90	Cover Plate - 2*6 Module - Graphic Casual	9972	1/8



5763 31



5762 90



5763 30



5757 16

Silver baroque cover plates with overmoulded frame

5758 53	Cover Plate - 1 Module - Silver Baroque	2598	1/5/30
5758 54	Cover Plate - 2 Module - Silver Baroque	2794	1/5/30
5758 55	Cover Plate - 3 Module - Silver Baroque	3002	1/0/20
5758 56	Cover Plate - 4 Module - Silver Baroque	3204	1/0/20
5758 57	Cover Plate - 6 Module - Silver Baroque	5800	1/0/5
5758 58	Cover Plate - 8 Module - Silver Baroque	6398	1/0/5
5758 59	Cover Plate - 2*4 Module - Silver Baroque	8054	1/0/10
5758 60	Cover Plate - 2*6 Module - Silver Baroque	9972	1/0/8
5758 61	Cover Plate - for Shaver Socket-3 Module - Silver Baroque	4100	1/5/50

5758 54



5758 55

Dark baroque cover plates with overmoulded frame

5758 62	Cover Plate - 1 Module - Dark Baroque	2598	1/5/30
5758 63	Cover Plate - 2 Module - Dark Baroque	2794	1/5/30
5758 64	Cover Plate - 3 Module - Dark Baroque	3002	1/0/20
5758 65	Cover Plate - 4 Module - Dark Baroque	3204	1/0/20
5758 66	Cover Plate - 6 Module - Dark Baroque	5800	1/0/5
5758 67	Cover Plate - 8 Module - Dark Baroque	6398	1/0/5
5758 68	Cover Plate - 2*4 Module - Dark Baroque	8052	1/0/10
5758 69	Cover Plate - 2*6 Module - Dark Baroque	9972	1/0/8
5758 70	Cover Plate - for Shaver Socket-3 Module - Dark Baroque	4100	1/5/50

5758 63



5758 64

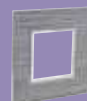

5758 81

Arteor™ square cover plates

Cat.Nos	Description	MRP* ₹ / Unit	Pack
---------	-------------	------------------	------

Metal finish cover plates with overmoulded frame Gold brass cover plates with overmoulded frame

5762 90	Cover Plate - 1 Module - Gold Brass	3486	1/5/30
5763 10	Cover Plate - 2 Module - Gold Brass	3730	1/5/30
5763 30	Cover Plate - 3 Module - Gold Brass	4014	1/20
5763 50	Cover Plate - 4 Module - Gold Brass	4258	1/20
5763 80	Cover Plate - 6 Module - Gold Brass	7748	1/5
5764 00	Cover Plate - 8 Module - Gold Brass	8518	1/5

Stainless steel cover plates with overmoulded frame

5757 06	Cover Plate - 1 Module - Stainless Steel	3486	1/5/30
5757 16	Cover Plate - 2 Module - Stainless Steel	3730	1/5/30
5757 26	Cover Plate - 3 Module - Stainless Steel	4014	1/20
5757 36	Cover Plate - 4 Module - Stainless Steel	4258	1/20
5757 46	Cover Plate - 6 Module - Stainless Steel	7748	1/5
5757 66	Cover Plate - 2*4 Module - Stainless Steel	10770	1/10
5757 56	Cover Plate - 8 Module - Stainless Steel	8518	1/5
5757 76	Cover Plate - 2*6 Module - Stainless Steel	13272	1/8

Wood cover plates with overmoulded frame

5758 80	Cover Plate - 1 Module - Grey Oak	2042	1/5/30
5758 81	Cover Plate - 2 Module - Grey Oak	2168	1/5/30
5758 82	Cover Plate - 3 Module - Grey Oak	2674	1/20
5758 83	Cover Plate - 4 Module - Grey Oak	2964	1/20
5758 84	Cover Plate - 6 Module - Grey Oak	4402	1/5
5758 85	Cover Plate - 8 Module - Grey Oak	5294	1/5
5758 86	Cover Plate - 2*4 Module - Grey Oak	6286	1/10
5758 87	Cover Plate - 2*6 Module - Grey Oak	8424	1/8
5758 88	Cover Plate - for Shaver Socket-3 Module - Grey Oak	2610	1/5/50

* MRP - Maximum Retail Price Inclusive of all taxes including GST.
Red Cat.Nos - new products

Bold Cat.Nos are products normally available with Legrand (India) Stockists. Cat.Nos that are not bold - delivery within 4 - 8 weeks from the date of order. Bold packing quantity is our mandatory packing. Orders to be placed by Legrand (India) Stockist in multiples of the same.

Arteor™ square cover plates

Cat.Nos	Description	MRP* ₹ / Unit	Pack
---------	-------------	------------------	------

Signature cover plates with overmoulded frame

5758 71	Cover Plate - 1 Module - Cube Plate	6680	1/5/30
5758 72	Cover Plate - 2 Module - Cube Plate	6802	1/5/30
5758 73	Cover Plate - 3 Module - Cube Plate	7778	1/20
5758 74	Cover Plate - 4 Module - Cube Plate	8038	1/20
5758 75	Cover Plate - 6 Module - Cube Plate	10468	1/5
5758 76	Cover Plate - 8 Module - Cube Plate	10988	1/5
5758 77	Cover Plate - 2*4 Module - Cube Plate	16416	1/10
5758 78	Cover Plate - 2*6 Module - Cube Plate	18186	1/8
5758 79	Cover Plate - for Shaver Socket-3 Module - Cube Plate	7458	1/5/50

Round cover plates with metal frame

Round - white cover plates with metal frame

5759 00	Cover Plate - 2 Module - White	396	10/100
5759 10	Cover Plate - 3 Module - White	418	10/100
5759 20	Cover Plate - 4 Module - White	442	5/50
5759 30	Cover Plate - 6 Module - White	806	5/30
5765 80	Cover Plate - 8 Module - White	890	5/30
5759 40	Cover Plate - 2*4 Module - White	940	2/20
5759 50	Cover Plate - 2*6 Module - White	1370	2/16

Round - pearl aluminium cover plates with metal frame

5757 93	Cover Plate - 2 Module - Pearl Aluminium	530	10/100
5757 94	Cover Plate - 3 Module - Pearl Aluminium	574	10/100
5757 95	Cover Plate - 4 Module - Pearl Aluminium	646	5/50
5757 96	Cover Plate - 6 Module - Pearl Aluminium	1100	5/30
5757 97	Cover Plate - 8 Module - Pearl Aluminium	1218	5/30
5757 98	Cover Plate - 2*4 Module - Pearl Aluminium	1538	2/20
5757 99	Cover Plate - 2*6 Module - Pearl Aluminium	2004	2/16

Round - graphite cover plates with metal frame

5758 03	Cover Plate - 2 Module - Graphite	530	10/100
5758 04	Cover Plate - 3 Module - Graphite	574	10/100
5758 05	Cover Plate - 4 Module - Graphite	646	5/50
5758 06	Cover Plate - 6 Module - Graphite	1096	5/30
5758 07	Cover Plate - 8 Module - Graphite	1218	5/30

* MRP - Maximum Retail Price Inclusive of all taxes including GST.
Red Cat.Nos - new products

Arteor™ round cover plate

Cat.Nos	Description	MRP* ₹ / Unit	Pack
---------	-------------	------------------	------

Round - graphite cover plates with metal frame

5758 08	Cover Plate - 2*4 Module - Graphite	1538	2/20
5758 09	Cover Plate - 2*6 Module - Graphite	2004	2/16

Round - magnesium cover plates with metal frame

5756 23	Cover Plate - 2 Module - Magnesium	530	10/100
5756 24	Cover Plate - 3 Module - Magnesium	574	10/100
5756 25	Cover Plate - 4 Module - Magnesium	646	5/50
5756 26	Cover Plate - 6 Module - Magnesium	1096	5/30
5756 27	Cover Plate - 8 Module - Magnesium	1216	5/30
5756 28	Cover Plate - 2*4 Module - Magnesium	1538	2/20
5756 29	Cover Plate - 2*6 Module - Magnesium	2004	2/16

Round - champagne cover plates with metal frame

5758 91	Cover Plate - 2 Module - Champagne	530	10/100
5758 92	Cover Plate - 3 Module - Champagne	574	10/100
5758 93	Cover Plate - 4 Module - Champagne	646	5/50
5758 94	Cover Plate - 6 Module - Champagne	1096	5/30
5758 95	Cover Plate - 8 Module - Champagne	1218	5/30
5758 96	Cover Plate - 2*4 Module - Champagne	1540	2/20
5758 97	Cover Plate - 2*6 Module - Champagne	2004	2/16

Round - dark bronze cover plates with metal frame

5756 93	Cover Plate - 2 Module - Dark Bronze	530	10/100
5756 94	Cover Plate - 3 Module - Dark Bronze	574	10/100
5756 95	Cover Plate - 4 Module - Dark Bronze	644	5/50
5756 96	Cover Plate - 6 Module - Dark Bronze	1096	5/30
5756 97	Cover Plate - 8 Module - Dark Bronze	1216	5/30
5756 98	Cover Plate - 2*4 Module - Dark Bronze	1538	2/20
5756 99	Cover Plate - 2*6 Module - Dark Bronze	2004	2/16

Round - pearl aluminium cover plates with overmoulded frame

5759 01	Cover Plate - 2 Module - Pearl Aluminium	600	10/100
5759 11	Cover Plate - 3 Module - Pearl Aluminium	632	10/100
5759 21	Cover Plate - 4 Module - Pearl Aluminium	670	5/50

Bold Cat.Nos are products normally available with Legrand (India) Stockists. Cat.Nos that are not bold - delivery within 4 - 8 weeks from the date of order. Bold packing quantity is our mandatory packing. Orders to be placed by Legrand (India) Stockist in multiples of the same.

Arteor™ round cover plates

Cat.Nos	Description	MRP* ₹ / Unit	Pack
---------	-------------	------------------	------

Round - pearl aluminium cover plates with overmoulded frame

5759 31	Cover Plate - 6 Module - Pearl Aluminium	1218	5/30
5765 81	Cover Plate - 8 Module - Pearl Aluminium	1340	5/30
5759 41	Cover Plate - 2*4 Module - Pearl Aluminium	1406	2/20
5759 51	Cover Plate - 2*6 Module - Pearl Aluminium	2082	2/16



5759 41

Round - graphite cover plates with overmoulded frame

5759 02	Cover Plate - 2 Module - Graphite	600	10/100
5759 12	Cover Plate - 3 Module - Graphite	632	10/100
5759 22	Cover Plate - 4 Module - Graphite	670	5/50
5759 32	Cover Plate - 6 Module - Graphite	1218	5/30
5765 82	Cover Plate - 8 Module - Graphite	1340	5/30
5759 42	Cover Plate - 2*4 Module - Graphite	1406	2/20
5759 52	Cover Plate - 2*6 Module - Graphite	2082	2/16



5759 22

Round - magnesium cover plates with overmoulded frame

5768 41	Cover Plate - 2 Module - Magnesium	600	10/100
5768 42	Cover Plate - 3 Module - Magnesium	632	10/100
5768 43	Cover Plate - 4 Module - Magnesium	670	5/50
5768 44	Cover Plate - 6 Module - Magnesium	1218	5/30
5768 45	Cover Plate - 8 Module - Magnesium	1340	5/30
5768 46	Cover Plate - 2*4 Module - Magnesium	1406	2/20
5768 47	Cover Plate - 2*6 Module - Magnesium	2082	2/16



5768 43



5768 47

Round - champagne cover plates with overmoulded frame

5768 48	Cover Plate - 2 Module - Champagne	600	10/100
5768 49	Cover Plate - 3 Module - Champagne	632	10/100
5768 50	Cover Plate - 4 Module - Champagne	670	5/50
5768 51	Cover Plate - 6 Module - Champagne	1218	5/30
5768 52	Cover Plate - 8 Module - Champagne	1340	5/30
5768 53	Cover Plate - 2*4 Module - Champagne	1406	2/20
5768 54	Cover Plate - 2*6 Module - Champagne	2082	2/16



5768 49



5768 50

* MRP - Maximum Retail Price Inclusive of all taxes including GST.
Red Cat.Nos - new products

Arteor™ round cover plates

Cat.Nos	Description	MRP* ₹ / Unit	Pack
---------	-------------	------------------	------

Round - dark bronze cover plates with overmoulded frame

5768 55	Cover Plate - 2 Module - Dark Bronze	600	10/100
5768 56	Cover Plate - 3 Module - Dark Bronze	632	10/100
5768 57	Cover Plate - 4 Module - Dark Bronze	670	5/50
5768 58	Cover Plate - 6 Module - Dark Bronze	1218	5/30
5768 59	Cover Plate - 8 Module - Dark Bronze	1340	5/30
5768 60	Cover Plate - 2*4 Module - Dark Bronze	1406	2/20
5768 61	Cover Plate - 2*6 Module - Dark Bronze	2082	2/16



5768 56

round mirror finish cover plates

Round - mirror black cover plates with overmoulded frame

5759 03	Cover Plate - 2 Module - Mirror Black	2522	1/5/30
5759 13	Cover Plate - 3 Module - Mirror Black	2704	1/20
5759 23	Cover Plate - 4 Module - Mirror Black	2876	1/20
5759 33	Cover Plate - 6 Module - Mirror Black	5204	1/5
5765 83	Cover Plate - 8 Module - Mirror Black	5748	1/5
5759 43	Cover Plate - 2*4 Module - Mirror Black	6776	1/10
5759 53	Cover Plate - 2*6 Module - Mirror Black	8958	1/8



5759 03

Round - mirror white cover plates with overmoulded frame

5759 04	Cover Plate - 2 Module - Mirror White	2522	1/5/30
5759 14	Cover Plate - 3 Module - Mirror White	2704	1/20
5759 24	Cover Plate - 4 Module - Mirror White	2876	1/20
5759 34	Cover Plate - 6 Module - Mirror White	5204	1/5
5765 84	Cover Plate - 8 Module - Mirror White	5748	1/5
5759 44	Cover Plate - 2*4 Module - Mirror White	6918	1/10
5759 54	Cover Plate - 2*6 Module - Mirror White	8958	1/8



5759 04

Bold Cat.Nos are products normally available with Legrand (India) Stockists. Cat.Nos that are not bold - delivery within 4 - 8 weeks from the date of order. Bold packing quantity is our mandatory packing. Orders to be placed by Legrand (India) Stockist in multiples of the same.

Arteor™ round cover plates

Cat.Nos	Description	MRP* ₹ / Unit	Pack
---------	-------------	------------------	------

Round - green apple cover plates with overmoulded frame

5768 62	Cover Plate - 2 Module - Green Apple	2522	1/5/30
5768 63	Cover Plate - 3 Module - Green Apple	2704	1/20
5768 64	Cover Plate - 4 Module - Green Apple	2876	1/20
5768 65	Cover Plate - 6 Module - Green Apple	5202	1/5
5768 66	Cover Plate - 8 Module - Green Apple	5748	1/5
5768 67	Cover Plate - 2*4 Module - Green Apple	6914	1/10
5768 68	Cover Plate - 2*6 Module - Green Apple	8958	1/8

Round - graphic casual cover plates with overmoulded frame

5763 01	Cover Plate - 2 Module - Graphic Casual	3080	1/5/30
5763 21	Cover Plate - 3 Module - Graphic Casual	3298	1/20
5763 41	Cover Plate - 4 Module - Graphic Casual	3520	1/20
5763 61	Cover Plate - 6 Module - Graphic Casual	6382	1/5
5763 91	Cover Plate - 8 Module - Graphic Casual	7028	1/5
5768 97	Cover Plate - 2*4 Module - Graphic Casual	8430	1/10
5768 98	Cover Plate - 2*6 Module - Graphic Casual	10966	1/8

Round - silver baroque cover plates with overmoulded frame

5768 69	Cover Plate - 2 Module - Silver Baroque	3080	1/5/30
5768 70	Cover Plate - 3 Module - Silver Baroque	3298	1/20
5768 71	Cover Plate - 4 Module - Silver Baroque	3520	1/20
5768 72	Cover Plate - 6 Module - Silver Baroque	6382	1/5
5768 73	Cover Plate - 8 Module - Silver Baroque	7028	1/5
5768 74	Cover Plate - 2*4 Module - Silver Baroque	8430	1/10
5768 75	Cover Plate - 2*6 Module - Silver Baroque	10966	1/8

* MRP - Maximum Retail Price Inclusive of all taxes including GST.
Red Cat.Nos - new products

Arteor™ round cover plates

Cat.Nos	Description	MRP* ₹ / Unit	Pack
---------	-------------	------------------	------

Round - dark baroque cover plates with overmoulded frame

5768 76	Cover Plate - 2 Module - Dark Baroque	3080	1/5/30
5768 77	Cover Plate - 3 Module - Dark Baroque	3298	1/20
5768 78	Cover Plate - 4 Module - Dark Baroque	3520	1/20
5768 79	Cover Plate - 6 Module - Dark Baroque	6382	1/5
5768 80	Cover Plate - 8 Module - Dark Baroque	7028	1/5
5768 81	Cover Plate - 2*4 Module - Dark Baroque	8430	1/10
5768 82	Cover Plate - 2*6 Module - Dark Baroque	10966	1/8

Round - metal finish cover plates

Round - gold brass cover plates with overmoulded frame

5763 00	Cover Plate - 2 Module - Gold Brass	4114	1/5/30
5763 20	Cover Plate - 3 Module - Gold Brass	4392	1/20
5763 40	Cover Plate - 4 Module - Gold Brass	4686	1/20
5763 60	Cover Plate - 6 Module - Gold Brass	8514	1/5
5763 90	Cover Plate - 8 Module - Gold Brass	9378	1/5

Round - stainless steel cover plates with overmoulded frame

5759 06	Cover Plate - 2 Module - Stainless Steel	4114	1/5/30
5759 16	Cover Plate - 3 Module - Stainless Steel	4392	1/20
5759 26	Cover Plate - 4 Module - Stainless Steel	4686	1/20
5759 36	Cover Plate - 6 Module - Stainless Steel	8514	1/5

Bold Cat.Nos are products normally available with Legrand (India) Stockists. Cat.Nos that are not bold - delivery within 4 - 8 weeks from the date of order. Bold packing quantity is our mandatory packing. Orders to be placed by Legrand (India) Stockist in multiples of the same.

Arteor™ round cover plates

Cat.Nos	Description	MRP* ₹ / Unit	Pack
---------	-------------	------------------	------

Round - stainless steel cover plates with overmoulded frame

5765 86	Cover Plate - 8 Module - Stainless Steel	9378	1/5
5759 46	Cover Plate - 2*4 Module - Stainless Steel	11858	1/10
5759 56	Cover Plate - 2*6 Module - Stainless Steel	14596	1/8

Round - wood cover plates with overmoulded frame

5768 90	Cover Plate - 2 Module - Grey Oak	2166	1/5/30
5768 91	Cover Plate - 3 Module - Grey Oak	3202	1/20
5768 92	Cover Plate - 4 Module - Grey Oak	3320	1/20
5768 93	Cover Plate - 6 Module - Grey Oak	4716	1/5
5768 94	Cover Plate - 8 Module - Grey Oak	5746	1/5
5768 95	Cover Plate - 2*4 Module - Grey Oak	6138	1/10
5768 96	Cover Plate - 2*6 Module - Grey Oak	7858	1/8

Round - signature cover plates with overmoulded frame

5768 83	Cover Plate - 2 Module - Cube Plate	6802	1/5/30
5768 84	Cover Plate - 3 Module - Cube Plate	8266	1/20
5768 85	Cover Plate - 4 Module - Cube Plate	8418	1/20
5768 86	Cover Plate - 6 Module - Cube Plate	10776	1/5
5768 87	Cover Plate - 8 Module - Cube Plate	11432	1/5
5768 88	Cover Plate - 2*4 Module - Cube Plate	15904	1/10
5768 89	Cover Plate - 2*6 Module - Cube Plate	17996	1/8

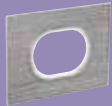

5768 91



5768 96



5768 84



5735 70



6890 07



6890 08



6890 09

Arteor™ mounting boxes

Cat.Nos	Description	MRP* ₹ / Unit	Pack
---------	-------------	------------------	------

Accessories

Plastic surface boxes

5734 91	Plastic Surface Box - 1/2 Module	134	55
5735 20	Plastic Surface Box - 3 Module	160	42
5735 70	Plastic Surface Box - 4 Module	192	27
5735 71	Plastic Surface Box - 6 Module	238	20
5723 94	Plastic Surface Box - 8 Module	268	20
5735 74	Plastic Surface Box - 2*4 Module	330	10
5735 72	Plastic Surface Box - 12/16 Module	844	11
5735 73	Plastic Surface Box - 18/24 Module	894	8

Metal flush boxes

6890 07	Metal Flush Box - 1/2 Module	144	40
6890 08	Metal Flush Box - 3 Module	144	40
6890 09	Metal Flush Box - 4 Module	190	40
6890 10	Metal Flush Box - 6 Module	302	40
6890 42	Metal Flush Box - 8 Module	352	40
6890 31	Metal Flush Box - 2*4 Module	350	20
6890 11	Metal Flush Box - 12/16 Module	530	10

* MRP - Maximum Retail Price Inclusive of all taxes including GST.
Red Cat.Nos - new products

Bold Cat.Nos are products normally available with Legrand (India) Stockists. Cat.Nos that are not bold - delivery within 4 - 8 weeks from the date of order. Bold packing quantity is our mandatory packing. Orders to be placed by Legrand (India) Stockist in multiples of the same.

Arteor™ mounting boxes

Cat.Nos	Description	MRP* ₹ / Unit	Pack
---------	-------------	---------------------	------

Metal flush boxes

6890 12	Metal Flush Box - 18/24 Module	668	10
---------	-----------------------------------	-----	----



6890 12

IP 55 plexo box and accessories

6846 38	Grey Plexo Box & Adaptor with Transparent Flap- 3 Module-IP 66	5258	1
---------	--	------	---



6846 38

IP 55 plexo box with PVC membrane

6806 11	Grey Plexo Box & Adaptor with PVC Membrane- 1 Module	1160	10
6806 12	Grey Plexo Box & Adaptor with PVC Membrane- 2 Module	1186	10
6806 13	Grey Plexo Box & Adaptor with PVC Membrane- 3 Module	1576	10
6806 14	Grey Plexo Box & Adaptor with PVC Membrane- 4 Module	2366	5
6806 19	Grey Plexo Box & Adaptor with PVC Membrane- 2 Row*4 Module	3834	5
6806 33	Grey Plexo Flush Adaptor with Membrane- 3 Module Arteor Box	1262	20



6806 12



6806 13



6806 19



6806 33

Arteor™

Guarantee

- The Company, at its discretion, will replace products if they have any manufacturing defect within 10 years for switches (without LED lamp) and power sockets. For all other **Arteor™** wiring accessories the guarantee will be 2 years.
- The above guarantee is applicable when the devices are used in Legrand metal flush boxes. Otherwise the guarantee period will be reduced by 50%.
- The guarantee is only applicable when the products are installed as per the Company's instructions and not tampered in any manner.
- The guarantee states the Company's entire liability. It does not extend to cover consequential loss or damage or installation costs arising from defective products.

* MRP - Maximum Retail Price Inclusive of all taxes including GST.
Red Cat.Nos - new products

ARTEOR™ IoT

ADD A TOUCH OF SMARTNESS

THE SMART RADIO SOLUTION

Arteor IoT offers, a radio-based solution for the connected home. The intelligent products communicate with one another via radio ZigBee 3.0 (2.4 GHz waveband). This means there is no need for specific or extensive cabling. Also, although the range only contains a few products, these can be used to create lots of individual solutions for a more customized feel at home.

SIMPLE, ADAPTABLE, OPEN

Radio-based Arteor has been designed and developed as a simple solution to make every house more individual, convenient and secure. Simple for planners, who are able to integrate many useful functions without having to provide for complicated cabling. Simple for installers, who are able to install the system without a great deal of effort or specialist knowledge. Simple for users, who will find it convenient to operate, easy to extend and are able to make changes at any time.



THE HOME + CONTROL APP FOR SMARTPHONE OR TABLET

The app on the smartphone or tablet opens up new options: monitoring of instantaneous power consumption, remote surveillance of the connected home, and control over various functions when the user is out and about.



Scan to know more about
the product.



LOCAL CONTROL GUARANTEED

Of course, all functions can still be used in the traditional way via switches on the wall. If furniture needs to be rearranged or small children need to be able to reach a switch, the wireless switches can be repositioned easily at any time.



Home + Control App

iPhone, iPod and iPad are registered trademarks of Apple Inc., registered in the US and other countries. HomeKit is a trademark of Apple Inc. App store is a service mark of Apple Inc., Google, Android, Google Play, and the Google Play logo are trademarks of Google LLC. Amazon, Alexa and all related logos are trademarks of Amazon.com, Inc. or its affiliates.

ARTEOR™ IoT

SMART HOMES,
SMARTER
CONVENIENCE!

**COMPACT & THOUGHTFUL FOR
ENHANCED CONVENIENCE!**

At Legrand, it is our promise to enhance convenience at every point of interaction. The process of designengineering that we follow ensures the best of fusion between the design and engineering. Arteor's connected offer launched in 2019, has witness huge success due to its unique style and unmatched range of functions. Further raising the bar, Arteor IoT range is enhanced with the addition of several new products, to ensure that you live the advantage.



**DIMMER WITH
NEUTRAL 1M 150W**



**4 SCENARIO CONTROL
WIRELESS SW**



**WIRELESS
2 GANG SWITCH**

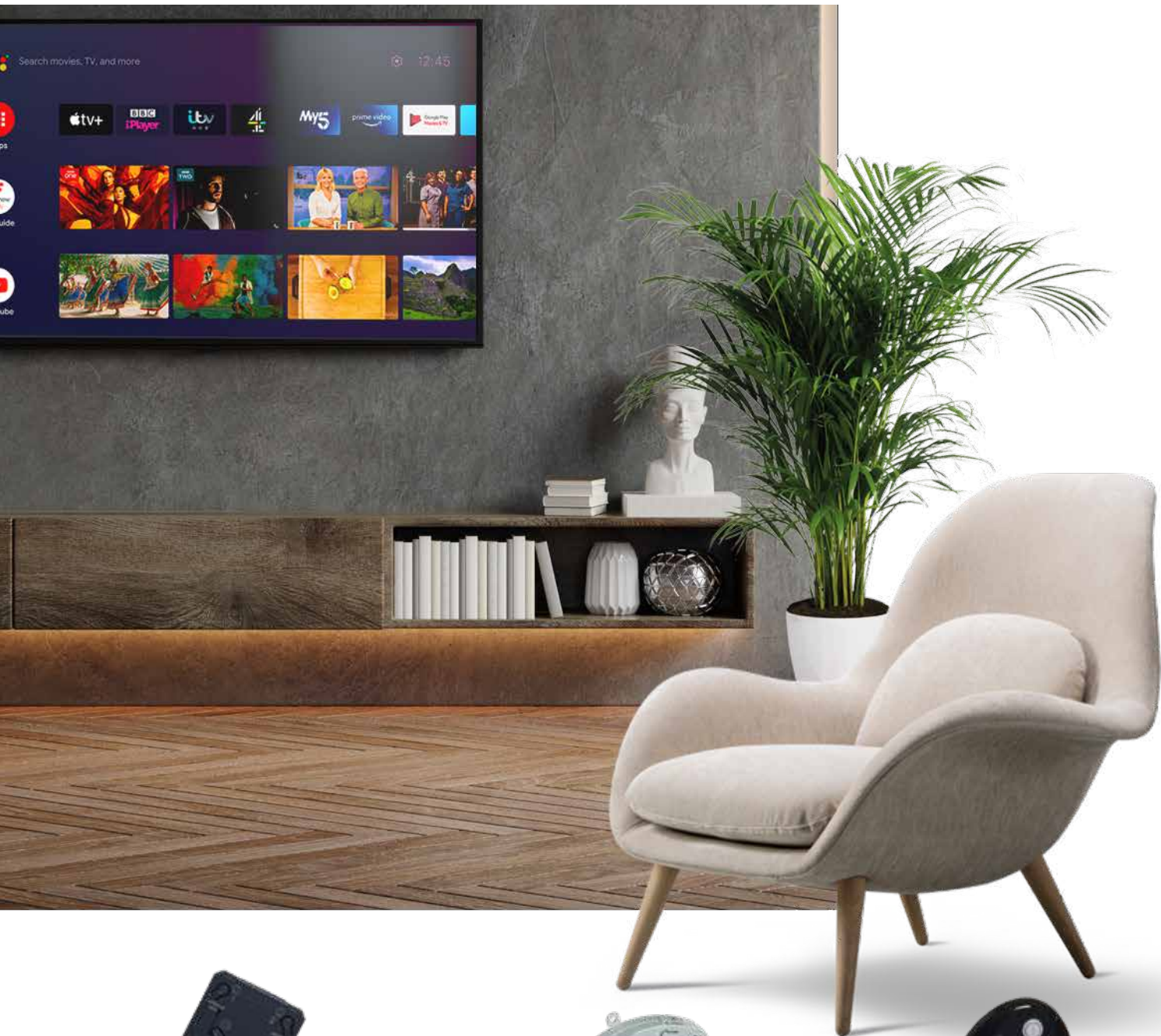

AUXILIARY WIRELESS SWITCH



SHUTTER MICRO MODULE



PORTABLE REMOTE

CX³

ADDING COMFORT IS SIMPLICITY ITSELF

With our smart electrical panel solutions and the Home + Control app, you have the benefit of a complete system for controlling your electrical installation on any type of site, from private houses to large blocks of flats.



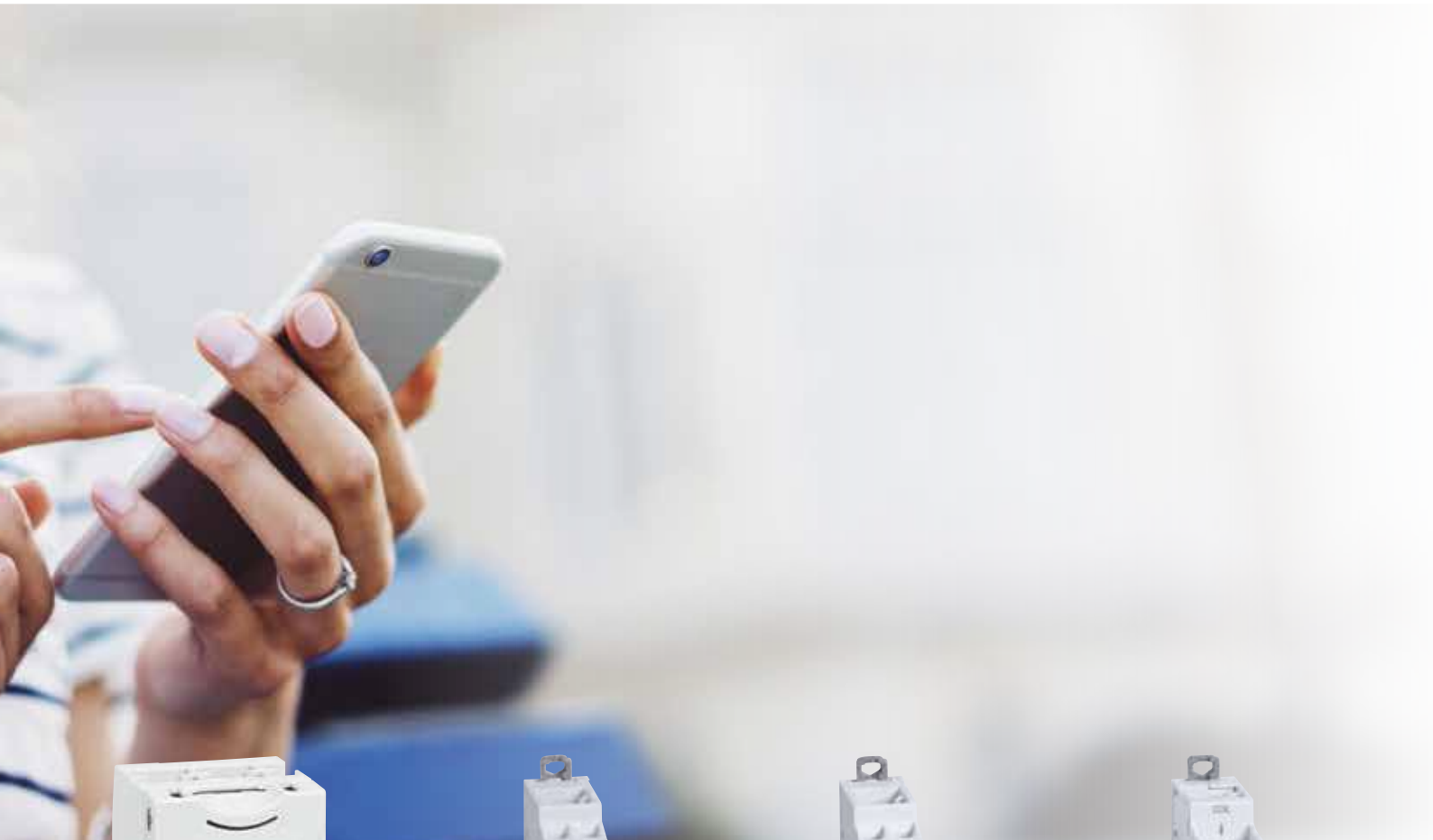

GATEWAY MODULE



SMART CONTACTOR



SMART LATCHING RELAY



ENERGY METER



Arteor™

connected home - white mechanism

Cat.Nos	Description	MRP* ₹ / Unit	Pack
---------	-------------	------------------	------

Connected light switches

5742 01	Connected Switch - with Neutral - Wired - 1 Module - White	9494	1/0/24
5742 02	Connected Switch - without Neutral - with Dimmer Option - Wired - 2 Module - White	15354	1/0/12
5743 40	Connected Switch Dimmer - with Neutral - 150 Watts - 1 Module - White	10902	1/0/24

Connected outlets

5742 00	16A - Connected Socket Module - 1 Module - White	10812	1/0/12
---------	--	-------	--------

Connected curtain/roller blind switches

5742 04	Connected Curtain/Roller Blind Switch - Wired - 1 Module - White	11546	1/0/24
---------	--	-------	--------

Connected step fan controller

5742 48	Connected Step Fan Controller - with Neutral -100W - 2 Module - White	7996	1/5/50
---------	---	------	--------

Connected gateway pack

5742 09	Connected Gateway + Master Home/Away Wireless Switch - Wired - 2 Module - White	23014	1/0/4
---------	---	-------	-------

Connected wireless controls

5742 05	Connected Wireless Light Switch - 2 Module - White	4928	1/0/10
5742 44	2G - Wireless Switch - White	5678	1/0/10
5742 07	Connected Curtain/Roller Blind Wireless Switch - 2 Module - White	5684	1/0/10

Connected wireless scene switches

5742 06	Connected Home/Away Wireless Master Switch - 2 Module - White	5768	1/0/10
5742 08	Connected Wake Up/Sleep Wireless Scenario Control Switch - 2 Module - White	5768	1/0/10
5743 12	Wireless 4 Scenes Switch - White	7204	1/0/10

Connected home- magnesium mechanism

Connected light switches

5742 20	Connected Switch - with Neutral - Wired - 1 Module - Magnesium	10924	1/0/24
5742 21	Connected Switch - without Neutral - with Dimmer Option - Wired - 2 Module - Magnesium	17654	1/0/12
5743 42	Connected Switch Dimmer - with Neutral - 150 Watts - 1 Module - Magnesium	12536	1/0/24

* MRP - Maximum Retail Price Inclusive of all taxes including GST.

■ To be Introduced Shortly

(1) Supplied with white plate

■ Price available on request

Arteor™

connected home - magnesium mechanism

Cat.Nos	Description	MRP* ₹ / Unit	Pack
---------	-------------	------------------	------

Connected outlets

5742 28	16A - Connected Socket Module - 1 Module - Magnesium	12562	1/0/12
---------	--	-------	--------

Connected curtain/roller blind switches

5742 22	Connected Curtain/Roller Blind Switch - Wired - 1 Module - Magnesium	13274	1/0/24
---------	--	-------	--------

Connected step fan controller

5742 50	Connected Step Fan Controller - with Neutral -100W - 2 Module - Magnesium	9194	1/5/50
---------	---	------	--------

Connected gateway pack

5742 27	Connected Gateway + Master Home/Away Wireless Switch - Wired - 2 Module - Magnesium	26460	1/0/4
---------	---	-------	-------

Connected wireless controls

5742 23	Connected Wireless Light Switch - 2 Module - Magnesium	5728	1/0/10
5742 46	2G - Wireless Switch - Magnesium	6528	1/0/10
5742 25	Connected Curtain/Roller Blind Wireless Switch - 2 Module - Magnesium	6538	1/0/10

Connected wireless scene switches

5742 24	Connected Home/Away Wireless Master Switch - 2 Module - Magnesium	6638	1/0/10
5742 26	Connected Wake Up/Sleep Wireless Scenario Control Switch - 2 Module - Magnesium	6638	1/0/10
5743 14	Wireless 4 Scenes Switch - Magnesium	8286	1/0/10

Connected home - champagne mechanism

Connected light switches

5742 29	Connected Switch - with Neutral - Wired - 1 Module - Champagne	10924	1/0/24
5742 30	Connected Switch - without Neutral - with Dimmer Option - Wired - 2 Module - Champagne	17654	1/0/12
5743 43	Connected Switch Dimmer - with Neutral - 150 Watts - 1 Module - Champagne	12536	1/0/24

Connected outlets

5742 37	16A - Connected Socket Module - 1 Module - Champagne	12562	1/0/12
---------	--	-------	--------

Connected curtain/roller blind switches

5742 31	Connected Curtain/Roller Blind Switch - Wired - 1 Module - Champagne	13274	1/0/24
---------	--	-------	--------



5742 01



5742 00



5742 04



5742 48



5742 09



5742 07



5742 06



5742 20



5743 42



5742 28



5742 27



5742 23



5742 24



5742 26



5742 29



5742 37



5742 31

Bold Cat.Nos are products normally available with Legrand (India) Stockists. Cat.Nos that are not bold - delivery within 4 - 8 weeks from the date of order. Bold packing quantity is our mandatory packing. Orders to be placed by Legrand (India) Stockist in multiples of the same.

Arteor™

connected home - champagne mechanism

Cat.Nos	Description	MRP* ₹ / Unit	Pack
---------	-------------	------------------	------

NEW!

Connected step fan controller

5742 51	Connected Step Fan Controller - with Neutral -100W - 2 Module - Champagne	9194	1/5/50
----------------	---	------	---------------

Connected gateway pack

5742 36	Connected Gateway + Master Home/Away Wireless Switch - Wired - 2 Module - Champagne	26460	1/0/4
---------	---	-------	-------

Connected wireless controls

5742 32	Connected Wireless Light Switch - 2 Module - Champagne	5672	1/0/10
5742 47	2G - Wireless Switch - Champagne	6528	1/0/10
5742 34	Connected Curtain/Roller Blind Wireless Switch - 2 Module - Champagne	6538	1/0/10

Connected wireless scene switches

5742 33	Connected Home/Away Wireless Master Switch - 2 Module - Champagne	6638	1/0/10
5742 35	Connected Wake Up/ Sleep Wireless Scenario Control Switch - 2 Module - Champagne	6638	1/0/10
5743 15	Wireless 4 Scenes Switch - Champagne	8286	1/0/10

Micro module switch & connected accessories

5742 43	Micro Module Switch - with Neutral - Black	7944	1/0/22
0676 97	Shutter Micromodule	10308	1
0676 94	Wireless Switch - On/Off Module for Mechanical Switch - (Auxiliary) - Black	9644	1
0676 95	Portable Remote - Black	12712	1

Cover plates

White cover plates with overmoulded frame

5758 98	Cover Plate - 1 Module - White	364	10/100
5758 99	Cover Plate - 2 Module - White	376	10/100
5759 60	Cover Plate - 3 Module - White	436	10/100
5759 65	Cover Plate - 4 Module - White	502	5/50
5759 94	Cover Plate - 6 Module - White	690	5/30
5759 95	Cover Plate - 8 Module - White	816	5/30
5759 96	Cover Plate - 2*4 Module - White	1192	2/20
5759 97	Cover Plate - 2*6 Module - White	1584	2/16
5759 98	Cover Plate - 2*8 Module - White	1740	2/16
5759 99	Cover Plate - 3*6 Module - White	2050	2/16

* MRP - Maximum Retail Price Inclusive of all taxes including GST.

■ To be Introduced Shortly

(1) Supplied with white plate

■ Price available on request

Arteor™

cover plates

Cat.Nos	Description	MRP* ₹ / Unit	Pack
---------	-------------	------------------	------

Pearl aluminium cover plates with overmoulded frame

5757 01	Cover Plate - 1 Module - Pearl Aluminium	430	10/100
5757 11	Cover Plate - 2 Module - Pearl Aluminium	454	10/100
5757 21	Cover Plate - 3 Module - Pearl Aluminium	486	10/100
5757 31	Cover Plate - 4 Module - Pearl Aluminium	548	5/50
5757 41	Cover Plate - 6 Module - Pearl Aluminium	934	5/30
5757 51	Cover Plate - 8 Module - Pearl Aluminium	1036	5/30
5757 61	Cover Plate - 2*4 Module - Pearl Aluminium	1314	2/20
5757 71	Cover Plate - 2*6 Module - Pearl Aluminium	1708	2/16
5757 81	Cover Plate - 2*8 Module - Pearl Aluminium	1940	2/16
5757 91	Cover Plate - 3*6 Module - Pearl Aluminium	2268	2/12

Graphite cover plates with overmoulded frame

5757 02	Cover Plate - 1 Module - Graphite	430	10/100
5757 12	Cover Plate - 2 Module - Graphite	454	10/100
5757 22	Cover Plate - 3 Module - Graphite	486	10/100
5757 32	Cover Plate - 4 Module - Graphite	548	5/50
5757 42	Cover Plate - 6 Module - Graphite	934	5/30
5757 52	Cover Plate - 8 Module - Graphite	1036	5/30
5757 62	Cover Plate - 2*4 Module - Graphite	1314	2/20
5757 72	Cover Plate - 2*6 Module - Graphite	1708	2/16
5757 82	Cover Plate - 2*8 Module - Graphite	1940	2/16
5757 92	Cover Plate - 3*6 Module - Graphite	2268	2/12

Bold Cat.Nos are products normally available with Legrand (India) Stockists. Cat.Nos that are not bold - delivery within 4 - 8 weeks from the date of order. Bold packing quantity is our mandatory packing. Orders to be placed by Legrand (India) Stockist in multiples of the same.

Arteor™ cover plates

Cat.Nos	Description	MRP* ₹ / Unit	Pack
---------	-------------	---------------------	------

Magnesium cover plates with overmoulded frame

5758 11	Cover Plate - 1 Module - Magnesium	430	10/100
5758 12	Cover Plate - 2 Module - Magnesium	454	10/100
5758 13	Cover Plate - 3 Module - Magnesium	486	10/100
5758 14	Cover Plate - 4 Module - Magnesium	548	5/30
5758 15	Cover Plate - 6 Module - Magnesium	934	5/30
5758 16	Cover Plate - 8 Module - Magnesium	1036	5/30
5758 17	Cover Plate - 2*4 Module - Magnesium	1314	2/20
5758 18	Cover Plate - 2*6 Module - Magnesium	1708	2/16
5758 19	Cover Plate - 2*8 Module - Magnesium	1940	2/16
5758 20	Cover Plate - 3*6 Module - Magnesium	2268	2/12

Champagne cover plates with overmoulded frame

5758 22	Cover Plate - 1 Module - Champagne	430	10/100
5758 23	Cover Plate - 2 Module - Champagne	454	10/100
5758 24	Cover Plate - 3 Module - Champagne	486	10/100
5758 25	Cover Plate - 4 Module - Champagne	548	5/50
5758 26	Cover Plate - 6 Module - Champagne	934	5/30
5758 27	Cover Plate - 8 Module - Champagne	1036	5/30
5758 28	Cover Plate - 2*4 Module - Champagne	1314	2/20
5758 29	Cover Plate - 2*6 Module - Champagne	1708	2/16
5758 30	Cover Plate - 2*8 Module - Champagne	1940	2/16
5758 31	Cover Plate - 3*6 Module - Champagne	2268	2/12

* MRP - Maximum Retail Price Inclusive of all taxes including GST.
 ■ To be Introduced Shortly
 (1) Supplied with white plate
 ■ Price available on request

Arteor™ cover plates

Cat.Nos	Description	MRP* ₹ / Unit	Pack
---------	-------------	---------------------	------

Dark bronze cover plates with overmoulded frame

5758 33	Cover Plate - 1 Module - Dark Bronze	430	10/100
5758 34	Cover Plate - 2 Module - Dark Bronze	454	10/100
5758 35	Cover Plate - 3 Module - Dark Bronze	486	10/100
5758 36	Cover Plate - 4 Module - Dark Bronze	548	5/50
5758 37	Cover Plate - 6 Module - Dark Bronze	934	5/30
5758 38	Cover Plate - 8 Module - Dark Bronze	1036	5/30
5758 39	Cover Plate - 2*4 Module - Dark Bronze	1314	2/20
5758 40	Cover Plate - 2*6 Module - Dark Bronze	1708	2/16
5758 41	Cover Plate - 2*8 Module - Dark Bronze	1940	2/16
5758 42	Cover Plate - 3*6 Module - Dark Bronze	2268	2/12

Mirror finish cover plates with overmoulded frame Mirror black cover plates with overmoulded frame

5757 03	Cover Plate - 1 Module - Mirror Black	2140	1/5/30
5757 13	Cover Plate - 2 Module - Mirror Black	2286	1/5/30
5757 23	Cover Plate - 3 Module - Mirror Black	2450	1/20
5757 33	Cover Plate - 4 Module - Mirror Black	2604	1/20
5757 43	Cover Plate - 6 Module - Mirror Black	4738	1/5
5757 53	Cover Plate - 8 Module - Mirror Black	5218	1/5
5757 63	Cover Plate - 2*4 Module - Mirror Black	6614	1/10
5757 73	Cover Plate - 2*6 Module - Mirror Black	8138	1/8

Bold Cat.Nos are products normally available with Legrand (India) Stockists. Cat.Nos that are not bold - delivery within 4 - 8 weeks from the date of order. Bold packing quantity is our mandatory packing. Orders to be placed by Legrand (India) Stockist in multiples of the same.

Arteor™

cover plates

Cat.Nos	Description	MRP* ₹ / Unit	Pack
---------	-------------	------------------	------

Mirror white cover plates with overmoulded frame

5757 04	Cover Plate - 1 Module - Mirror White	2140	1/5/30
5757 14	Cover Plate - 2 Module - Mirror White	2286	1/5/30
5757 24	Cover Plate - 3 Module - Mirror White	2450	1/20
5757 34	Cover Plate - 4 Module - Mirror White	2604	1/20
5757 44	Cover Plate - 6 Module - Mirror White	4738	1/5
5757 54	Cover Plate - 8 Module - Mirror White	5218	1/5
5757 64	Cover Plate - 2*4 Module - Mirror White	6736	1/10
5757 74	Cover Plate - 2*6 Module - Mirror White	8138	1/8



5757 14



5757 74

Mirror green apple cover plates with overmoulded frame

5758 44	Cover Plate - 1 Module - Green Apple	2140	1/5/30
5758 45	Cover Plate - 2 Module - Green Apple	2286	1/5/30
5758 46	Cover Plate - 3 Module - Green Apple	2450	1/20
5758 47	Cover Plate - 4 Module - Green Apple	2604	1/20
5758 48	Cover Plate - 6 Module - Green Apple	4738	1/5
5758 49	Cover Plate - 8 Module - Green Apple	5218	1/5
5758 50	Cover Plate - 2*4 Module - Green Apple	6734	1/10
5758 51	Cover Plate - 2*6 Module - Green Apple	8138	1/8



5758 45

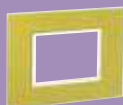

5758 46

Graphic casual cover plates with overmoulded frame

5762 91	Cover Plate - 1 Module - Graphic Casual	2598	1/5/30
5763 11	Cover Plate - 2 Module - Graphic Casual	2794	1/5/30
5763 31	Cover Plate - 3 Module - Graphic Casual	3002	1/20
5763 51	Cover Plate - 4 Module - Graphic Casual	3204	1/20
5763 81	Cover Plate - 6 Module - Graphic Casual	5800	1/5
5764 01	Cover Plate - 8 Module - Graphic Casual	6398	1/5
5758 89	Cover Plate - 2*4 Module - Graphic Casual	8054	1/10
5758 90	Cover Plate - 2*6 Module - Graphic Casual	9972	1/8



5763 31

Arteor™

cover plates

Cat.Nos	Description	MRP* ₹ / Unit	Pack
---------	-------------	------------------	------

Silver baroque cover plates with overmoulded frame

5758 53	Cover Plate - 1 Module - Silver Baroque	2598	1/5/30
5758 54	Cover Plate - 2 Module - Silver Baroque	2794	1/5/30
5758 55	Cover Plate - 3 Module - Silver Baroque	3002	1/0/20
5758 56	Cover Plate - 4 Module - Silver Baroque	3204	1/0/20
5758 57	Cover Plate - 6 Module - Silver Baroque	5800	1/0/5
5758 58	Cover Plate - 8 Module - Silver Baroque	6398	1/0/5
5758 59	Cover Plate - 2*4 Module - Silver Baroque	8054	1/0/10
5758 60	Cover Plate - 2*6 Module - Silver Baroque	9972	1/0/8



5758 54



5758 55

Dark baroque cover plates with overmoulded frame

5758 62	Cover Plate - 1 Module - Dark Baroque	2598	1/5/30
5758 63	Cover Plate - 2 Module - Dark Baroque	2794	1/5/30
5758 64	Cover Plate - 3 Module - Dark Baroque	3002	1/0/20
5758 65	Cover Plate - 4 Module - Dark Baroque	3204	1/0/20
5758 66	Cover Plate - 6 Module - Dark Baroque	5800	1/0/5
5758 67	Cover Plate - 8 Module - Dark Baroque	6398	1/0/5
5758 68	Cover Plate - 2*4 Module - Dark Baroque	8052	1/0/10
5758 69	Cover Plate - 2*6 Module - Dark Baroque	9972	1/0/8



5758 63



5758 64

Metal finish cover plates with overmoulded frame

Gold brass cover plates with overmoulded frame

5762 90	Cover Plate - 1 Module - Gold Brass	3486	1/5/30
5763 10	Cover Plate - 2 Module - Gold Brass	3730	1/5/30
5763 30	Cover Plate - 3 Module - Gold Brass	4014	1/20
5763 50	Cover Plate - 4 Module - Gold Brass	4258	1/20
5763 80	Cover Plate - 6 Module - Gold Brass	7748	1/5
5764 00	Cover Plate - 8 Module - Gold Brass	8518	1/5



5762 90



5763 30

* MRP - Maximum Retail Price Inclusive of all taxes including GST.

(1) Supplied with white plate

*Suitable only for wireless switch, ■ Price available on request

Bold Cat.Nos are products normally available with Legrand (India) Stockists. Cat.Nos that are not bold - delivery within 4 - 8 weeks from the date of order. Bold packing quantity is our mandatory packing. Orders to be placed by Legrand (India) Stockist in multiples of the same.

Arteor™ cover plates

Cat.Nos	Description	MRP* ₹ / Unit	Pack
---------	-------------	---------------------	------

Stainless steel cover plates with overmoulded frame

5757 06	Cover Plate - 1 Module - Stainless Steel	3486	1/5/30
5757 16	Cover Plate - 2 Module - Stainless Steel	3730	1/5/30
5757 26	Cover Plate - 3 Module - Stainless Steel	4014	1/20
5757 36	Cover Plate - 4 Module - Stainless Steel	4258	1/20
5757 46	Cover Plate - 6 Module - Stainless Steel	7748	1/5
5757 66	Cover Plate - 2*4 Module - Stainless Steel	10770	1/10
5757 56	Cover Plate - 8 Module - Stainless Steel	8518	1/5
5757 76	Cover Plate - 2*6 Module - Stainless Steel	13272	1/8



5757 16

Wood cover plates with overmoulded frame

5758 80	Cover Plate - 1 Module - Grey Oak	2042	1/5/30
5758 81	Cover Plate - 2 Module - Grey Oak	2168	1/5/30
5758 82	Cover Plate - 3 Module - Grey Oak	2674	1/20
5758 83	Cover Plate - 4 Module - Grey Oak	2964	1/20
5758 84	Cover Plate - 6 Module - Grey Oak	4402	1/5
5758 85	Cover Plate - 8 Module - Grey Oak	5294	1/5
5758 86	Cover Plate - 2*4 Module - Grey Oak	6286	1/10
5758 87	Cover Plate - 2*6 Module - Grey Oak	8424	1/8



5758 81

* MRP - Maximum Retail Price Inclusive of all taxes including GST.
 # To be Introduced Shortly
 (1) Supplied with white plate
 ■ Price available on request

Arteor™ cover plates

Cat.Nos	Description	MRP* ₹ / Unit	Pack
---------	-------------	---------------------	------

Signature cover plates with overmoulded frame

5758 71	Cover Plate - 1 Module - Cube Plate	6680	1/5/30
5758 72	Cover Plate - 2 Module - Cube Plate	6802	1/5/30
5758 73	Cover Plate - 3 Module - Cube Plate	7778	1/20
5758 74	Cover Plate - 4 Module - Cube Plate	8038	1/20
5758 75	Cover Plate - 6 Module - Cube Plate	10468	1/5
5758 76	Cover Plate - 8 Module - Cube Plate	10988	1/5
5758 77	Cover Plate - 2*4 Module - Cube Plate	16416	1/10
5758 78	Cover Plate - 2*6 Module - Cube Plate	18186	1/8



5758 72



5758 73

Cover plates without frame

5757 10PL	Cover Plate without Frame- for Wireless Switch- 2 Module-White	170	5/50
5757 11PL	Cover Plate without Frame- for Wireless Switch- 2 Module-Pearl Aluminium	346	5/50
5757 12PL	Cover Plate without Frame- for Wireless Switch- 2 Module-Graphite	274	5/50
5758 12PL	Cover Plate without Frame- for Wireless Switch- 2 Module-Magnesium	346	5/50
5758 23PL	Cover Plate without Frame- for Wireless Switch- 2 Module-Champagne	346	5/50
5758 34PL	Cover Plate without Frame- for Wireless Switch- 2 Module-Dark Bronze	346	5/50



5757 10



5757 11



5757 12

Accessory

0648 71	Pack of 3*4 Extra Removable Stickers for Fixing A Wireless Control	806	1/25
---------	--	-----	------

Bold Cat.Nos are products normally available with Legrand (India) Stockists.
 Cat.Nos that are not bold - delivery within 4 - 8 weeks from the date of order.
 Bold packing quantity is our mandatory packing. Orders to be placed by
 Legrand (India) Stockist in multiples of the same.

NEW

10A SWITCHES

Switch Type: 10A 1Way



Myrius

Mylinc

Lyncus

Allzy

Switch Type: 10A 2Way



Myrius

Mylinc

Lyncus

Allzy

Switch Type: 10A 1Way With Indicator



Myrius

Mylinc

Lyncus

Allzy

Colour: White

RANGES: Myrius™ | Mylinc™ | Lyncus™ | Allzy™



Myrius™



+ Myrius™
More is on.

Experience the best of both worlds as they become one.



As Myrius and Myrius NextGen become one, the comprehensive Myrius brand range will now offer the best of both worlds with designer finishes, beautiful hues and patterns achieved through IMD technology along with IOT functions (currently referred to as Myrius NextGen range) and the classic black and white range (currently referred to as Myrius range) will now be called as Myrius Regular under one brand Myrius.

Myrius:
the best of
both worlds



Myrius

(Comprehensive one brand)

Myrius

(Earlier referred to as Myrius NextGen)



White



Ice Black



Ice White



Interlude



Charcoal Grey



Luminar



Stellar



Dark Fade



Sonic Silver



Champagne

Myrius Regular

(Earlier referred to as Myrius)



Snowy white



Black beauty

Myrius™

INSPIRED BY YOUR
LOVE FOR AESTHETICS
AND CONVENIENCE

Who said beauty has to be compromised at the hands of technology! The Myrius range seamlessly combines the aesthetic beauty of designer finishes with hues and patterns, achieved through cutting-edge IMD technology, with the intelligence of IoT functions. This means customized, smart functions for you to enjoy the convenience of living and a stunning designer look that will turn heads, every time guests come over.



NEW

IMD FINISHES



ICE GRAPHITE



ICE SILK

Introducing 2 new color finishes



Scan to know more about
the product.



Luminar Trinity Interlude Stellar Sonic Silver Pearl Champagne Dark Fade Ice White Ice Black Classic White Ice Graphite Ice Silk Charcoal Grey

Myrius™

INSPIRED BY YOUR
HEALTH-FIRST MANTRA

You prioritize your family's health, hygiene and wellness more than anything else. Inspired, we've created anti-bacterial plates infused with silver ions, which do not let bacteria grow on the surface of Switches and Plates and Accessories throughout its lifespan. One less reason to worry about germs being passed on at home. Live the advantage of a healthy home



ANTI-BACTERIAL RANGE



BLDC FAN REGULATOR

NOW COMPATIBLE WITH BLDC FANS

This technology seamlessly integrates with BLDC Fans (non-remote), providing users with enhanced control over their environment. Utilizing a sophisticated 5-step regulator, individuals can effortlessly adjust the fan speed to their desired level, allowing for personalized comfort and energy efficiency.



NEW



Myrius



Mylicnc



Lyncus



Allzy

Available in **white** and **color mechanism** finishes

RANGES: Myrius™ | Mylicnc™ | Lyncus™ | Allzy™

*Please note that only the following models are supported: Atomberg (Efficio), Havells (Efficiencia neo), and Orient (Aerostorm) as of the 2023 models.
 *Suitable for Fans with declaration from manufacturers for application of Step fan regulator

Myrius™ classic white- mechanism

Cat.Nos	Description	MRP* ₹ / Unit	Pack
---------	-------------	------------------	------

Switches 6A - 230V AC

6792 00	6A - Switch - 1 Way - 1 Module	146	1/20/200
6792 01	6A - Switch - 2 Way - 1 Module	252	1/20/200
6792 02	6A - Switch - 1 Way - with Indicator - 1 Module	234	1/20/200
6792 03	6A - Switch - 1 Way - with "Light" Marking - 1 Module	198	1/20/200
6792 04	6A - Switch - 1 Way - with "Fan" Marking - 1 Module	198	1/20/200

Switches - 10A - 230V AC

6793 00	10A - Switch - 1 Way - 1 Module	152	20/200
6793 01	10A - Switch - 2 Way - 1 Module	256	20/200
6793 02	10A - Switch - 1 Way - with Indicator - 1 Module	238	20/200
6792 05	10A - Switch - 1 Way - 2 Module	292	1/10/100
6792 06	10A - Switch - 2 Way - 2 Module	346	1/10/100
6792 07	10A - Intermediate Switch - 230V AC - 2 Module	1888	1/10/100
6792 08	10A - Switch - 1 Way - with Indicator - 2 Module	362	1/10/100

Switches - 16A - 230V AC

6792 09	16A - Switch - 1 Way - 1 Module	330	1/20/200
6792 10	16A - Switch - 2 Way - 1 Module	376	1/20/200
6792 11	16A - Switch - 1 Way - with Indicator - 1 Module	398	1/20/200

Switches - 20A - 230V AC

6792 12	20A - Switch - 1 Way - 1 Module	438	1/20/200
6792 13	20A - Switch - DP - 1 Way - 2 Module	666	1/10/100
6792 14	20A - Switch - DP - 1 Way - with Indicator - 2 Module	712	1/10/100
6792 15	20A - Switch - 2 Way - 2 Module	736	1/10/100

Switches - 25A - 230V AC

6792 16	25A - Switch - SP - 1 Way - with Indicator - 1 Module	490	1/20/200
---------	---	-----	----------

Switches - 32A - 230V AC

6792 17	32A - Switch - DP - with Indicator - 2 Module	1092	1/10/100
---------	---	------	----------

Myrius™ classic white- mechanism

Cat.Nos	Description	MRP* ₹ / Unit	Pack
---------	-------------	------------------	------

Push button - 6A - 230V AC

6792 18	6A - Push Button - SP - 1 Module	278	1/20/200
6792 19	6A - Push Button - SP - 1 Way - with Indicator - 1 Module	362	1/20/200
6792 20	6A - Bell Push - 1 Way - 1 Module	276	1/20/200
6792 21	6A - Bell Push - 1 Way - with Indicator - 1 Module	362	1/20/200
6792 22	6A - Bell Push - 1 Way - 2 Module	420	1/10/100
6792 23	6A - Bell Push - 1 Way - with Indicator - 2 Module	490	1/10/100

Accessories for switches

6792 24	Lamp for Switches - 230V AC	64	1/5/50
---------	-----------------------------	----	--------

Indian standard socket

6792 35	6A - Socket - with Shutter - 3 Pin - ISI - 2 Module	228	1/20/200
6792 30	6/16A - Socket - with Shutter - ISI - 2 Module	482	1/10/100
6792 29	6/16A - Socket - with Shutter - ISI - 3 Module	578	1/5/50
6792 26	16A - Switch Socket - with Shutter - 3 Pin - 3 Module	1248	1/5/50
6792 32	25A - Socket - with Shutter - 2 Module	614	1/10/100

Dimmers and fan regulators

6792 36	Rotary Dimmer - 400 Watts - 1 Module	1218	5/50
6792 37	Rotary Light Dimmer - 500 Watts - 2 Module	1838	10/100
6792 39	Fan Regulator - 100 Watts - ISI - 1 Module	946	5/50
6792 40	Fan Regulator - 100 Watts - 360° - ISI - 2 Module	1084	10/100
6792 41	Fan Regulator - 120 Watts - 360° - ISI - 2 Module	1172	10/100
6792 42	Fan Regulator - 70 Watts - ISI - 2 Module	1136	1/10/100
6792 31	Fan Regulator - 8 Step - 100 Watts - 2 Module	992	10/100
6792 96	Fan Regulator - BLDC - 2 Module [^]	1158	10/100

* MRP - Maximum Retail Price Inclusive of all taxes including GST.

■ Price available on request

▲ Compatible with Atomberg (Efficio), Havells (Efficiencia neo), Orient (Aerostorm) as per 2023 fan models.

Bold Cat.Nos are products normally available with Legrand (India) Stockists. Cat.Nos that are not bold - delivery within 4 - 8 weeks from the date of order. Bold packing quantity is our mandatory packing. Orders to be placed by Legrand (India) Stockist in multiples of the same.

Myrius™ classic white- mechanism

Cat.Nos	Description	MRP ₹ / Unit	Pack
---------	-------------	--------------------	------

Emergency light

6792 43	Emergency Removable LED Lamp - 2 Module	3032	1/10/100
---------	---	------	----------

Skirting light

6792 48	Skirting Light - with Warm White LED - 3 Module	918	1/5/25
---------	---	-----	--------

Indicator

6792 87	Indicator Unit - with Transparent LED & Colored Labels - 1 Module	706	1/10/100
---------	---	-----	----------

Bell call indicator

6792 49	Bell Call Indicator - 1 Module	1206	1/20/200
---------	--------------------------------	------	----------

Buzzer

6792 50	Buzzer - 230V - 1 Module	1306	1/20/200
---------	--------------------------	------	----------

Infrared sensors

6792 51	Infrared Sensor Switch - 400 Watts - 2 Module	2134	1/50
---------	---	------	------

Remote unit

6792 52	Remote Control Unit - for Light & Fan - 4 Module	7282	1/5/20
---------	--	------	--------

6793 03	Remote Control Hand Unit	642	1/5/30
---------	--------------------------	-----	--------

Hospitality Function

Hotel keycard switch

6792 53	15A - Key Card Switch - 2 Module	4368	1/10
---------	----------------------------------	------	------

6792 55	Key Fob for Key Card Switch	190	1/10/100
---------	-----------------------------	-----	----------

Hotel "DND and MMR" functions

6792 56	External DND & MMR Control Unit - with Bell Push - 2 Module	1862	1/10/100
---------	---	------	----------

6792 57	Internal DND & MMR Control Unit - 2 Module	1244	1/10/100
---------	--	------	----------

Shaver socket

6792 58	Shaver Socket - 110/230V AC - Monoblock with Plate - 2 Module	3250	1/16
---------	---	------	------

6792 59	Shaver Socket - 110/230V AC - Monoblock with Plate - 4 Module	5308	1/5/20
---------	---	------	--------

TV sockets

6792 60	TV Co - axial Socket - 1 Module	246	1/20/200
---------	---------------------------------	-----	----------

Data & voice

6792 62	Telephone Socket - RJ11 - 1 Module	244	1/20/200
---------	------------------------------------	-----	----------

6792 63	Telephone Socket - Double RJ11 - 1 Module	376	1/20/200
---------	---	-----	----------

6792 64	Information Socket - RJ45 - Cat 5 - UTP - Toolless with Shutter - 1 Module	530	1/20/200
---------	--	-----	----------

6792 65	Information Socket - RJ45 - Cat 6 - UTP - Toolless with Shutter - 1 Module	788	1/20/200
---------	--	-----	----------

6792 66	Information Socket - RJ45 - Cat 6 - UTP - Toolless with Shutter - 2 Module	802	1/10/100
---------	--	-----	----------

6797 13	Information Socket - RJ45 - Cat 6A - STP - 1 Module	924	20/200
----------------	---	-----	--------

--	--	--	--

--	--	--	--

--	--	--	--

--	--	--	--

--	--	--	--

Myrius™ classic white- mechanism

Cat.Nos	Description	MRP ₹ / Unit	Pack
---------	-------------	--------------------	------

Audio video connectors

6792 67	Preterminated Audio/Video Connector - 1 Module	1895	1/10
---------	--	------	------

6792 68	Preterminated Projector Connector - 1 Module	2322	1/10
---------	--	------	------

6792 69	Preterminated HDMI Socket - 1 Module	2322	1/10
---------	--------------------------------------	------	------

Sound (volume controller)

6792 70	Volume Controller - 2 Module	1418	1/10/100
---------	------------------------------	------	----------

Protectors & accessories

Motor starter

6792 71	16A - Motor Starter - 2 Module	778	1/10/100
---------	--------------------------------	-----	----------

6792 72	25A - Motor Starter - 2 Module	794	1/10/100
---------	--------------------------------	-----	----------

Electronic function

USB chargers (IS13252 (Part 1) / IEC 609501)

6792 88	USB Charger - 1500mA - Type A - 1 Module	1672	1/5/50
---------	--	------	--------

6792 90	USB Charger - 1500mA - Type C - 1 Module	1838	1/5/50
---------	--	------	--------

6792 89	USB Charger - 3000mA - Type A + C - 2 Module	2588	1/10/100
---------	--	------	----------

6797 51	USB Charger - 3000mA/15 Watts - Type A - 1 Module	1934	1/5/50
----------------	---	------	--------

6797 52	USB Charger - 3000mA/15 Watts - Type A + A - 1 Module	2178	1/5/50
----------------	---	------	--------

6797 53	USB Charger - 3000mA/15 Watts - Type A + C - 1 Module	2774	1/5/50
----------------	---	------	--------

6797 54	USB Charger - 3000mA/15 Watts - Type C + C - 1 Module	3032	1/5/50
----------------	---	------	--------

6797 55	USB Charger - Power Delivery - 20 Watts - Type C - 1 Module	3690	1/5/50
----------------	---	------	--------

6792 73	USB Charger - Power Delivery - 30 Watts - Type C + C - 2 Module	5598	1/3/30
----------------	---	------	--------

6797 57	USB Charger - Power Delivery - 45 Watts - Type C - 2 Module	7300	1/3/30
----------------	---	------	--------

6797 58	USB Charger - Power Delivery - 63 Watts - Type C + C - 3 Module	9002	1/5/20
----------------	---	------	--------

--	--	--	--

--	--	--	--

--	--	--	--

--	--	--	--

--	--	--	--

--	--	--	--

--	--	--	--

--	--	--	--

--	--	--	--

--	--	--	--

--	--	--	--

--	--	--	--

--	--	--	--

--	--	--	--

--	--	--	--

* MRP - Maximum Retail Price Inclusive of all taxes including GST.

■ To be Introduced Shortly

(1) Supplied with white plate

■ Price available on request

Bold Cat.Nos are products normally available with Legrand (India) Stockists. Cat.Nos that are not bold - delivery within 4 - 8 weeks from the date of order. Bold packing quantity is our mandatory packing. Orders to be placed by Legrand (India) Stockist in multiples of the same.

Myrius™ classic white- mechanism

Cat.Nos	Description	MRP* ₹ / Unit	Pack
---------	-------------	------------------	------

Touch switches

6793 08	Touch Switch - 2 Switch - 1 Way - 1000 Watts - 2 Module - Silver	3748	1/50
6793 09	Touch Switch - 1 Way - 1440 Watts - 2 Module - Silver	3748	1/50
6793 10	Touch Switch - 2 Way - 1000 Watts - 2 Module - Silver	4332	1/50
6793 13	Touch Switch - 1 Way - 3000 Watts - 2 Module - Silver	4332	1/50
6793 06	Touch Switch - Bell Push - 1440 Watts - 2 Module - Silver	3748	1/50

Touch regulator, curtain & dimmer

6793 07	Touch Switch - Curtain Controller - 2 Module - Silver	4332	1/50
6793 05	Touch Fan Regulator - 100 Watts - 2 Module - Silver	4332	1/50
6793 15	Universal LED Touch Scroll Dimmer - 300 Watts - 2 Module - Silver	4288	1/50

Reading light

6793 16	Reading Light LED - 2 Module	2520	1/10
---------	------------------------------	------	------

Accessories

6792 75	Cable Outlet - 8mm - 1 Module	276	1/20/200
6792 76	Blanking Plate - 1 Module	52	1/40/400
6792 77	Blanking Plate - 2 Module	60	1/10/100

Charcoal grey- mechanism

Switches - 6A - 230V AC

6794 00	6A - Switch - 1 Way - 1 Module	178	1/20/200
6794 01	6A - Switch - 2 Way - 1 Module	278	1/20/200
6794 02	6A - Switch - 1 Way - with Indicator - 1 Module	304	1/20/200
6794 03	6A - Switch - 1 Way - with "Light" Marking - 1 Module	236	1/20/200
6794 04	6A - Switch - 1 Way - with "Fan" Marking - 1 Module	236	1/20/200

Switches - 6A - 230V AC

6794 05	10A - Switch - 1 Way - 2 Module	350	1/10/100
6794 06	10A - Switch - 2 Way - 2 Module	376	1/10/100
6794 07	10A - Intermediate Switch - 230V AC - 2 Module	2174	1/10/100
6794 08	10A - Switch - 1 Way - with Indicator - 2 Module	404	1/10/100

Myrius™ charcoal grey- mechanism

Cat.Nos	Description	MRP* ₹ / Unit	Pack
---------	-------------	------------------	------

Switches - 16A - 230V AC

6794 09	16A - Switch - 1 Way - 1 Module	368	1/20/200
6794 10	16A - Switch - 2 Way - 1 Module	446	1/20/200
6794 11	16A - Switch - 1 Way - with Indicator - 1 Module	462	1/20/200

Switches - 20A - 230V AC

6794 12	20A - Switch - 1 Way - 1 Module	494	1/20/200
6794 13	20A - Switch - DP - 1 Way - 2 Module	772	1/10/100
6794 14	20A - Switch - DP - 1 Way - with Indicator - 2 Module	820	1/10/100
6794 15	20A - Switch - 2 Way - 2 Module	844	1/10/100

Switches - 25A - 230V AC

6794 16	25A - Switch - SP - 1 Way - with Indicator - 1 Module	564	1/20/200
---------	---	-----	----------

Switches 32A 230V AC

6794 17	32A - Switch - DP - with Indicator - 2 Module	1260	1/10/100
---------	---	------	----------

Push button 6A 230V AC

6794 18	6A - Push Button - SP - 1 Way - 1 Module	328	1/20/200
6794 19	6A - Push Button - 1 Way - with Indicator - 1 Module	410	1/20/200
6794 20	6A - Bell Push - 1 Way - 1 Module	304	1/20/200
6794 21	6A - Bell Push - 1 Way - with Indicator - 1 Module	410	1/20/200
6794 22	6A - Bell Push - 1 Way - 2 Module	472	1/10/100
6794 23	6A - Bell Push - 1 Way - with Indicator - 2 Module	564	1/10/100

Indian standard socket

6794 35	6A - Socket - with Shutter - 3 Pin - ISI - 2 Module	258	1/20/200
6794 30	6/16A - Socket - with Shutter - ISI - 2 Module	568	1/10/100
6794 29	6/16A - Socket - with Shutter - ISI - 3 Module	670	1/5/50
6794 26	16A - Switched Socket - with Shutter - 3 Pin - 3 Module	1422	1/5/50
6794 32	25A - Socket - with Shutter - 2 Module	696	1/10/100

* MRP - Maximum Retail Price Inclusive of all taxes including GST.
■ Price available on request

Bold Cat.Nos are products normally available with Legrand (India) Stockists. Cat.Nos that are not bold - delivery within 4 - 8 weeks from the date of order. Bold packing quantity is our mandatory packing. Orders to be placed by Legrand (India) Stockist in multiples of the same.

Myrius™ charcoal grey- mechanism

Cat.Nos	Description	MRP ₹ / Unit	Pack
---------	-------------	--------------------	------

Dimmers and fan Regulators

6794 36	Rotary Dimmer - 400 Watts - 1 Module	1394	5/50
6794 37	Rotary Light Dimmer - 500 Watts - 2 Module	2114	10/100
6794 39	Fan Regulator - 100 Watts - ISI - 1 Module	1088	5/50
6794 40	Fan Regulator - 100 Watts - 360° - ISI - 2 Module	1232	10/100
6794 41	Fan Regulator - 120 Watts - 360° - ISI - 2 Module	1358	10/100
6794 42	Fan Regulator - 70 Watts - ISI - 2 Module	1312	1/10/100
6794 31	Fan Regulator - 8 Step - 100 Watts - 2 Module	1128	10/100
6794 96	Fan Regulator - BLDC - 2 Module [^]	1336	10/100

Skirting light

6794 48	Skirting Light - with Warm White LED - 3 Module	1050	1/5/25
---------	---	------	--------

Bell call indicator

6794 49	Bell Call Indicator - 1 Module	1406	1/20/200
---------	--------------------------------	------	----------

Buzzer

6794 50	Buzzer - 230V - 1 Module	1498	1/20/200
---------	--------------------------	------	----------

Remote unit

6794 52	Remote Control Unit - for Light & Fan - 4 Module	8370	1/5/20
6793 03	Remote Control Hand Unit	642	1/5/30

Hospitality function Hotel keycard switch

6794 53	15A - Key Card Switch - 2 Module	5022	1/10
6792 55	Key Fob for Key Card Switch	190	1/10/100

Hotel "DND and MMR" functions

6794 54	External DND & MMR Control Unit - with Bell Push - 2 Module	2136	1/10/100
6794 55	Internal DND & MMR Control Unit - 2 Module	1408	1/10/100

Shaver socket

6794 58	Shaver Socket - 120/240V AC - Monoblock with Plate - 2 Module	3702	1/16
6794 59	Shaver Socket - 120/230V AC - Monoblock with Plate - 4 Module	5872	1/5/20

Sockets and connectors

TV sockets

6794 60	TV Co - axial Socket - 1 Module	296	1/20/200
---------	---------------------------------	-----	----------

Myrius™ charcoal grey- mechanism

Cat.Nos	Description	MRP ₹ / Unit	Pack
---------	-------------	--------------------	------

Data & voice

6794 62	Telephone Socket - RJ11 - 1 Module	284	1/20/200
6794 63	Telephone Socket - Double RJ11 - 1 Module	436	1/20/200
6794 64	Information Socket - RJ45 - Cat 5 - UTP - Toolless with Shutter - 1 Module	613	1/20/200
6794 65	Information Socket - RJ45 - Cat 6 - UTP - Toolless with Shutter - 1 Module	905	1/20/200
6794 66	Information Socket - RJ45 - Cat 6 - UTP - Toolless with Shutter - 2 Module	928	1/10/100
6797 14	Information Socket - RJ45 - Cat 6A - STP - 1 Module	1056	20/200

Audio & video connectors

6794 67	Preterminated Audio/Video Connector - 1 Module	2176	1/10
6794 68	Preterminated HDMI Socket - 1 Module	2668	1/10
6794 69	Preterminated Projector Connector - 1 Module	2668	1/10

Sound (volume controller)

6794 70	Volume Controller - 2 Module	1646	1/10/100
---------	------------------------------	------	----------

Protectors & accessories

Motor starter

6794 71	16A - Motor Starter - 2 Module	896	1/10/100
6794 72	25A - Motor Starter - 2 Module	918	1/10/100

Electronic function

USB chargers (IS13252 (Part 1) / IEC 60950-1)

6794 88	USB Charger - 1500mA - Type A - 1 Module	1918	1/5/100
6794 90	USB Charger - 1500mA - Type C - 1 Module	2114	1/5/100
6794 89	USB Charger - 3000mA - Type A + C - 2 Module	2976	1/10/100
6798 51	USB Charger - 3000mA/15 Watts - Type A - 1 Module	2212	1/5/50
6798 52	USB Charger - 3000mA/15 Watts - Type A + A - 1 Module	2444	1/5/50
6798 53	USB Charger - 3000mA/15 Watts - Type A + C - 1 Module	3114	1/5/50
6798 54	USB Charger - 3000mA/15 Watts - Type C + C - 1 Module	3300	1/5/50
6798 55	USB Charger - Power Delivery - 20 Watts - Type C - 1 Module	4074	1/5/50
6792 74	USB Charger - Power Delivery - 30 Watts - Type C + C - 2 Module	5920	1/3/30
6798 57	USB Charger - Power Delivery - 45 Watts - Type C - 2 Module	7686	1/3/30
6798 58	USB Charger - Power Delivery - 63 Watts - Type C + C - 3 Module	9452	1/5/20

* MRP - Maximum Retail Price Inclusive of all taxes including GST.

• To be Introduced Shortly

(1) Supplied with white plate

■ Price available on request

[^] Compatible with Atomberg (Efficio), Havells (Eficiencia neo), Orient Aerostorm) as per 2023 fan models.

Bold Cat.Nos are products normally available with Legrand (India) Stockists. Cat.Nos that are not bold - delivery within 4 - 8 weeks from the date of order. Bold packing quantity is our mandatory packing. Orders to be placed by Legrand (India) Stockist in multiples of the same.

Myrius™ classic white - anti bacterial mechanism

Cat.Nos	Description	MRP ₹ / Unit	Pack
---------	-------------	--------------------	------

Sound receiver

6794 97	Bluetooth Sound Diffusion - 2 Module	6994	1/10/100
---------	--------------------------------------	------	----------

Rotary dimmer universal

6794 98	Rotary LED Light Dimmer - 50 Watts - 1 Module	2872	1/10/120
---------	---	------	----------

Accessories

6794 75	Cable Outlet - 8mm - 1 Module	324	1/20/200
6794 76	Blanking Plate - 1 Module	56	1/40/400

Classic white - anti bacterial mechanism Switches - 6A - 230V AC

6793 20	6A - Switch - 1 Way - 1 Module - Anti - Bacterial	210	1/20/200
6793 21	6A - Switch - 2 Way - 1 Module - Anti - Bacterial	296	1/20/200
6793 24	6A - Bell Push - 1 Module - Anti - Bacterial	338	1/20/200

Switches - 16A - 230V AC

6793 22	16A - Switch - 1 Way - 1 Module - Anti - Bacterial	398	1/20/200
6793 23	16A - Switch - 2 Way - 1 Module - Anti - Bacterial	462	1/20/200

Indian standard socket

6792 38	6A - Socket - with Shutter - 3 Pin - ISI - 2 Module - Anti - Bacterial	284	1/20/200
6793 28	6/16A - Socket - with Shutter - ISI - 2 Module - Anti - Bacterial	662	1/10/100
6793 29	6/16A - Socket - with Shutter - ISI - 3 Module - Anti - Bacterial	712	1/5/50

Fan regulators

6793 25	Fan Regulator - 120 Watts - 360° - 2 Module - Anti - Bacterial	1440	10/100
---------	--	------	--------

TV sockets

6793 30	TV Co - axial Socket - 1 Module - Anti - Bacterial	296	1/20/200
---------	--	-----	----------

Data & voice

6793 31	Telephone Socket - RJ11 - 1 Module - Anti - Bacterial	296	1/20/200
6793 32	Information Socket - RJ45 - Cat 6 - UTP - 1 Module - Anti - Bacterial	958	1/20/200

Accessories

6793 33	Blanking Plate - 1 Module - Anti - Bacterial	52	1/40/400
---------	--	----	----------

Myrius™ cover plates

Cat.Nos	Description	MRP ₹ / Unit	Pack
---------	-------------	--------------------	------

Cover plates with support frame

Classic white cover plates with support frame

6795 01	Cover Plate - 1 Module - Classic White	198	20/200
6795 02	Cover Plate - 2 Module - Classic White	206	20/200
6795 03	Cover Plate - 3 Module - Classic White	220	10/100
6795 04	Cover Plate - 4 Module - Classic White	244	10/100
6795 06	Cover Plate - 6 Module - Classic White	424	5/50
6795 08	Cover Plate - 8 Module - Classic White	464	5/50
6795 09	Cover Plate - 2*4 Module - Classic White	590	5/25
6795 10	Cover Plate - 9 Module - Classic White	622	5/50
6795 12	Cover Plate - 12 Module - Classic White	706	10
6795 16	Cover Plate - 16 Module - Classic White	822	10
6795 18	Cover Plate - 18 Module - Classic White	942	10

Ice white cover plates with support frame

6795 21	Cover Plate - 1 Module - Ice White	276	1/5/30
6795 22	Cover Plate - 2 Module - Ice White	292	1/5/30
6795 23	Cover Plate - 3 Module - Ice White	310	1/20
6795 24	Cover Plate - 4 Module - Ice White	332	1/20
6795 26	Cover Plate - 6 Module - Ice White	598	1/10
6795 28	Cover Plate - 8 Module - Ice White	652	1/10
6795 29	Cover Plate - 2*4 Module - Ice White	818	1/5
6795 32	Cover Plate - 12 Module - Ice White	992	1/5
6795 36	Cover Plate - 16 Module - Ice White	1156	1/5
6795 38	Cover Plate - 18 Module - Ice White	1326	1/5

Ice black cover plates with support frame

6795 41	Cover Plate - 1 Module - Ice Black	276	1/5/30
6795 42	Cover Plate - 2 Module - Ice Black	292	1/5/30
6795 43	Cover Plate - 3 Module - Ice Black	310	1/20
6795 44	Cover Plate - 4 Module - Ice Black	332	1/20
6795 46	Cover Plate - 6 Module - Ice Black	598	1/10
6795 48	Cover Plate - 8 Module - Ice Black	652	1/10
6795 49	Cover Plate - 2*4 Module - Ice Black	818	1/5
6795 52	Cover Plate - 12 Module - Ice Black	992	1/5
6795 56	Cover Plate - 16 Module - Ice Black	1156	1/5
6795 58	Cover Plate - 18 Module - Ice Black	1326	1/5

Bold Cat.Nos are products normally available with Legrand (India) Stockists. Cat.Nos that are not bold - delivery within 4 - 8 weeks from the date of order. **Bold packing quantity** is our mandatory packing. Orders to be placed by Legrand (India) Stockist in multiples of the same.

* MRP - Maximum Retail Price Inclusive of all taxes including GST.
Red Cat.Nos - new products
■ Price available on request.

Myrius™ cover plates



Cat.Nos	Description	MRP ₹ / Unit	Pack
---------	-------------	--------------------	------

Charcoal grey cover plates with support frame

6797 01	Cover Plate - 1 Module - Charcoal Grey	240	20/200
6797 02	Cover Plate - 2 Module - Charcoal Grey	252	20/200
6797 03	Cover Plate - 3 Module - Charcoal Grey	272	10/100
6797 04	Cover Plate - 4 Module - Charcoal Grey	294	10/100
6797 06	Cover Plate - 6 Module - Charcoal Grey	522	5/50
6797 08	Cover Plate - 8 Module - Charcoal Grey	570	5/50
6797 09	Cover Plate - 2*4 Module - Charcoal Grey	722	5/25
6797 10	Cover Plate - 9 Module - Charcoal Grey	776	5/50
6797 12	Cover Plate - 12 Module - Charcoal Grey	866	1/10
6797 16	Cover Plate - 16 Module - Charcoal Grey	1004	1/10
6797 18	Cover Plate - 18 Module - Charcoal Grey	1154	1/10

Pearl champagne cover plates with support frame

6795 61	Cover Plate - 1 Module - Pearl Champagne	376	1/5/30
6795 62	Cover Plate - 2 Module - Pearl Champagne	398	1/5/30
6795 63	Cover Plate - 3 Module - Pearl Champagne	422	1/20
6795 64	Cover Plate - 4 Module - Pearl Champagne	458	1/20
6795 66	Cover Plate - 6 Module - Pearl Champagne	818	1/10
6795 68	Cover Plate - 8 Module - Horizontal - Pearl Champagne	892	1/10
6795 69	Cover Plate - 2*4 Module - Vertical - Pearl Champagne	1118	1/5
6795 72	Cover Plate - 12 Module - Pearl Champagne	1352	1/5
6795 76	Cover Plate - 16 Module - Pearl Champagne	1572	1/5
6795 78	Cover Plate - 18 Module - Pearl Champagne	1810	1/5

Sonic silver cover plates with support frame

6795 81	Cover Plate - 1 Module - Sonic Silver	376	1/5/30
6795 82	Cover Plate - 2 Module - Sonic Silver	398	1/5/30
6795 83	Cover Plate - 3 Module - Sonic Silver	422	1/20
6795 84	Cover Plate - 4 Module - Sonic Silver	458	1/20
6795 86	Cover Plate - 6 Module - Sonic Silver	818	1/10
6795 88	Cover Plate - 8 Module - Horizontal - Sonic Silver	892	1/10
6795 89	Cover Plate - 2*4 Module - Vertical - Sonic Silver	1118	1/5
6795 92	Cover Plate - 12 Module - Sonic Silver	1352	1/5
6795 96	Cover Plate - 16 Module - Sonic Silver	1572	1/5
6795 98	Cover Plate - 18 Module - Sonic Silver	1810	1/5

* MRP - Maximum Retail Price Inclusive of all taxes including GST.

* To be Introduced Shortly

Red Cat.Nos - new products

(1) Supplied with white plate

■ Price available on request

Myrius™ cover plates

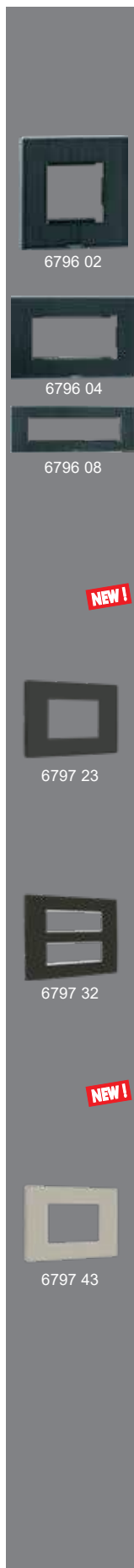

Cat.Nos	Description	MRP ₹ / Unit	Pack
---------	-------------	--------------------	------

Dark fade cover plates with support frame

6796 01	Cover Plate - 1 Module - Dark Fade	376	1/5/30
6796 02	Cover Plate - 2 Module - Dark Fade	398	1/5/30
6796 03	Cover Plate - 3 Module - Dark Fade	422	1/20
6796 04	Cover Plate - 4 Module - Dark Fade	458	1/20
6796 06	Cover Plate - 6 Module - Dark Fade	818	1/10
6796 08	Cover Plate - 8 Module - Horizontal - Dark Fade	892	1/10
6796 09	Cover Plate - 2*4 Module - Vertical - Dark Fade	1118	1/5
6796 12	Cover Plate - 12 Module - Dark Fade	1352	1/5
6796 16	Cover Plate - 16 Module - Dark Fade	1572	1/5
6796 18	Cover Plate - 18 Module - Dark Fade	1810	1/5

Ice Graphite cover plates with support frame

6797 21	Cover Plate - 1 Module - Ice Graphite	276	1/5/30
6797 22	Cover Plate - 2 Module - Ice Graphite	292	1/5/30
6797 23	Cover Plate - 3 Module - Ice Graphite	310	1/20
6797 24	Cover Plate - 4 Module - Ice Graphite	332	1/20
6797 26	Cover Plate - 6 Module - Ice Graphite	598	1/10
6797 28	Cover Plate - 8 Module - Horizontal - Ice Graphite	652	1/10
6797 29	Cover Plate - 2*4 Module - Vertical - Ice Graphite	820	1/5
6797 32	Cover Plate - 12 Module - Ice Graphite	990	1/5
6797 36	Cover Plate - 16 Module - Ice Graphite	1154	1/5
6797 38	Cover Plate - 18 Module - Ice Graphite	1326	1/5

Ice silk cover plates with support frame

6797 41	Cover Plate - 1 Module - Ice Silk	276	1/5/30
6797 42	Cover Plate - 2 Module - Ice Silk	292	1/5/30
6797 43	Cover Plate - 3 Module - Ice Silk	310	1/20
6797 44	Cover Plate - 4 Module - Ice Silk	332	1/20
6797 46	Cover Plate - 6 Module - Ice Silk	598	1/10
6797 48	Cover Plate - 8 Module - Horizontal - Ice Silk	652	1/10
6797 49	Cover Plate - 2*4 Module - Vertical - Ice Silk	820	1/5
6797 62	Cover Plate - 12 Module - Ice Silk	990	1/5
6797 56	Cover Plate - 16 Module - Ice Silk	1154	1/5
6797 68	Cover Plate - 18 Module - Ice Silk	1326	1/5

Bold Cat.Nos are products normally available with Legrand (India) Stockists. Cat.Nos that are not bold - delivery within 4 - 8 weeks from the date of order. Bold packing quantity is our mandatory packing. Orders to be placed by Legrand (India) Stockist in multiples of the same.

Myrius™ cover plates

Cat.Nos	Description	MRP ₹ / Unit	Pack
---------	-------------	--------------------	------

Interlude cover plates with support frame

6796 21	Cover Plate - 1 Module - Interlude	496	1/5/30
6796 22	Cover Plate - 2 Module - Interlude	520	1/5/30
6796 23	Cover Plate - 3 Module - Interlude	558	1/20
6796 24	Cover Plate - 4 Module - Interlude	604	1/20
6796 26	Cover Plate - 6 Module - Interlude	1082	1/10
6796 28	Cover Plate - 8 Module - Horizontal - Interlude	1178	1/10
6796 29	Cover Plate - 2*4 Module - Vertical - Interlude	1476	1/5
6796 32	Cover Plate - 12 Module - Interlude	1782	1/5
6796 36	Cover Plate - 16 Module - Interlude	2082	1/5
6796 38	Cover Plate - 18 Module - Interlude	2386	1/5

Trinity cover plates with support frame

6796 41	Cover Plate - 1 Module - Trinity	496	1/5/30
6796 42	Cover Plate - 2 Module - Trinity	520	1/5/30
6796 43	Cover Plate - 3 Module - Trinity	558	1/20
6796 44	Cover Plate - 4 Module - Trinity	604	1/20
6796 46	Cover Plate - 6 Module - Trinity	1082	1/10
6796 48	Cover Plate - 8 Module - Horizontal - Trinity	1178	1/10
6796 49	Cover Plate - 2*4 Module - Vertical - Trinity	1476	1/5
6796 52	Cover Plate - 12 Module - Trinity	1782	1/5
6796 56	Cover Plate - 16 Module - Trinity	2082	1/5
6796 58	Cover Plate - 18 Module - Trinity	2386	1/5

Luminar cover plates with support frame

6796 61	Cover Plate - 1 Module - Luminar	496	1/5/30
6796 62	Cover Plate - 2 Module - Luminar	520	1/5/30
6796 63	Cover Plate - 3 Module - Luminar	558	1/20
6796 64	Cover Plate - 4 Module - Luminar	604	1/20
6796 66	Cover Plate - 6 Module - Luminar	1082	1/10
6796 68	Cover Plate - 8 Module - Horizontal - Luminar	1178	1/10
6796 69	Cover Plate - 2*4 Module - Vertical - Luminar	1476	1/5
6796 72	Cover Plate - 12 Module - Luminar	1782	1/5
6796 76	Cover Plate - 16 Module - Luminar	2082	1/5
6796 78	Cover Plate - 18 Module - Luminar	2386	1/5

Myrius™ cover plates

Cat.Nos	Description	MRP ₹ / Unit	Pack
---------	-------------	--------------------	------

Stellar cover plates with support frame

6796 81	Cover Plate - 1 Module - Stellar	496	1/5/30
6796 82	Cover Plate - 2 Module - Stellar	520	1/5/30
6796 83	Cover Plate - 3 Module - Stellar	558	1/20
6796 84	Cover Plate - 4 Module - Stellar	604	1/20
6796 86	Cover Plate - 6 Module - Stellar	1082	1/10
6796 88	Cover Plate - 8 Module - Horizontal - Stellar	1178	1/10
6796 89	Cover Plate - 2*4 Module - Vertical - Stellar	1476	1/5
6796 92	Cover Plate - 12 Module - Stellar	1782	1/5
6796 96	Cover Plate - 16 Module - Stellar	2082	1/5
6796 98	Cover Plate - 18 Module - Stellar	2386	1/5

Anti-Bacterial cover plates with support frame

6793 41	Cover Plate - 1 Module - Anti-Bacterial-Classic White	222	20/200
6793 42	Cover Plate - 2 Module - Anti-Bacterial-Classic White	246	20/200
6793 43	Cover Plate - 3 Module - Anti-Bacterial-Classic White	276	10/100
6793 44	Cover Plate - 4 Module - Anti-Bacterial-Classic White	294	10/100
6793 46	Cover Plate - 6 Module - Anti-Bacterial-Classic White	480	5/50
6793 48	Cover Plate - 8 Module - Horizontal - Anti-Bacterial-Classic White	566	5/50
6793 49	Cover Plate - 2*4 Module - Vertical - Anti-Bacterial-Classic White	706	5/25
6793 50	Cover Plate - 9 Module - Anti-Bacterial-Classic White	734	5/50
6793 52	Cover Plate - 12 Module - Anti-Bacterial-Classic White	810	10
6793 56	Cover Plate - 16 Module - Anti-Bacterial-Classic White	960	10
6793 58	Cover Plate - 18 Module - Anti-Bacterial-Classic White	1070	10

* MRP - Maximum Retail Price Inclusive of all taxes including GST.

■ To be Introduced Shortly

Red Cat.Nos - new products

(1) Supplied with white plate

■ Price available on request

Bold Cat.Nos are products normally available with Legrand (India) Stockists. Cat.Nos that are not bold - delivery within 4 - 8 weeks from the date of order. Bold packing quantity is our mandatory packing. Orders to be placed by Legrand (India) Stockist in multiples of the same.

Myrius™ mounting boxes

Cat.Nos	Description	MRP ₹ / Unit	Pack
---------	-------------	--------------------	------

Mounting boxes

Metal flush boxes



6890 07



6890 09



6890 10

6890 07	Metal Flush Box - 1/2 Module	144	40
6890 08	Metal Flush Box - 3 Module	144	40
6890 09	Metal Flush Box - 4 Module	190	40
6890 10	Metal Flush Box - 6 Module	302	40
6890 42	Metal Flush Box - 8 Module	352	40
6890 31	Metal Flush Box - 4*2 Module	350	20
6890 29	Metal Flush Box - 9 Module	416	20
6890 11	Metal Flush Box - 12/16 Module	530	10
6890 12	Metal Flush Box - 18/24 Module	668	10

Plastic surface boxes



6733 03

6733 02	Plastic Surface Box - 1/2 Module	92	10/50
6733 03	Plastic Surface Box - 3 Module	106	5/35
6733 04	Plastic Surface Box - 4 Module	124	5/25
6733 06	Plastic Surface Box - 6 Module	160	1/10
6733 08	Plastic Surface Box - 8 Module	238	1/5
6733 05	Plastic Surface Box - 4*2 Module	226	1/5

Metal surface boxes

6890 21	Metal Surface Box - 12 Module (2 Rows*6)	564	1/6
6890 22	Metal Surface Box - 18 Module (3 Rows*6)	594	1/4

* MRP - Maximum Retail Price Inclusive of all taxes including GST.

* To be Introduced Shortly

Red Cat.Nos - new products

(1) Supplied with white plate

■ Price available on request

Myrius™

Guarantee

- The Company, at its discretion, will replace products if they have any manufacturing defect within 10 years for switches (without LED lamp) and power sockets. For all other **Myrius™** wiring accessories the guarantee will be 2 years.
- The above guarantee is applicable when the devices are used in Legrand metal flush boxes. Otherwise the guarantee period will be reduced by 50%.
- The guarantee is only applicable when the products are installed as per the Company's instructions and not tampered in any manner.
- The guarantee states the Company's entire liability. It does not extend to cover consequential loss or damage or installation costs arising from defective products.

Myrius™ IoT

INSPIRED BY TOUCH,
SWIPE AND YOUR
VOICE.

Be it controlling operations of lights or curtains remotely or controlling power outlets or viewing energy consumption details – we've got your back in multiple ways that you love. Control functions via voice commands used in combination with multiple ways. You can still use it in the traditional way via switches on wall. Also even by simply swiping on the Home+Control Smartphone app by Legrand.



Scan to know more about
the product.



 works with the
Google Assistant



 WORKS WITH
alexa



 Works with
Apple HomeKit



Home +
Control App

Control with:

TOUCH | SWIPE | TALK

Myrius™

IoT

SMART SOLUTIONS
FOR YOUR SMART
NEED.

The Myrius IoT range has been meticulously crafted by us for you and your family's connected, real-time, smart living. Each product combines Legrand's design calibre and the intelligence of the Internet of Things, which brings convenience of different levels to you. Solutions and devices with the power to communicate with each other and complete tasks, supervise scenarios or monitor and give you crucial updates.



**WIRELESS 4
SCENARIO
CONTROL - 2M**



**SWITCH DIMMER
WITH
NEUTRAL - 1M**



**WIRELESS SWITCH
2G - 2M**



**IN WALL WIRELESS
SWITCH - 1M**



Scan to know more about
the product.

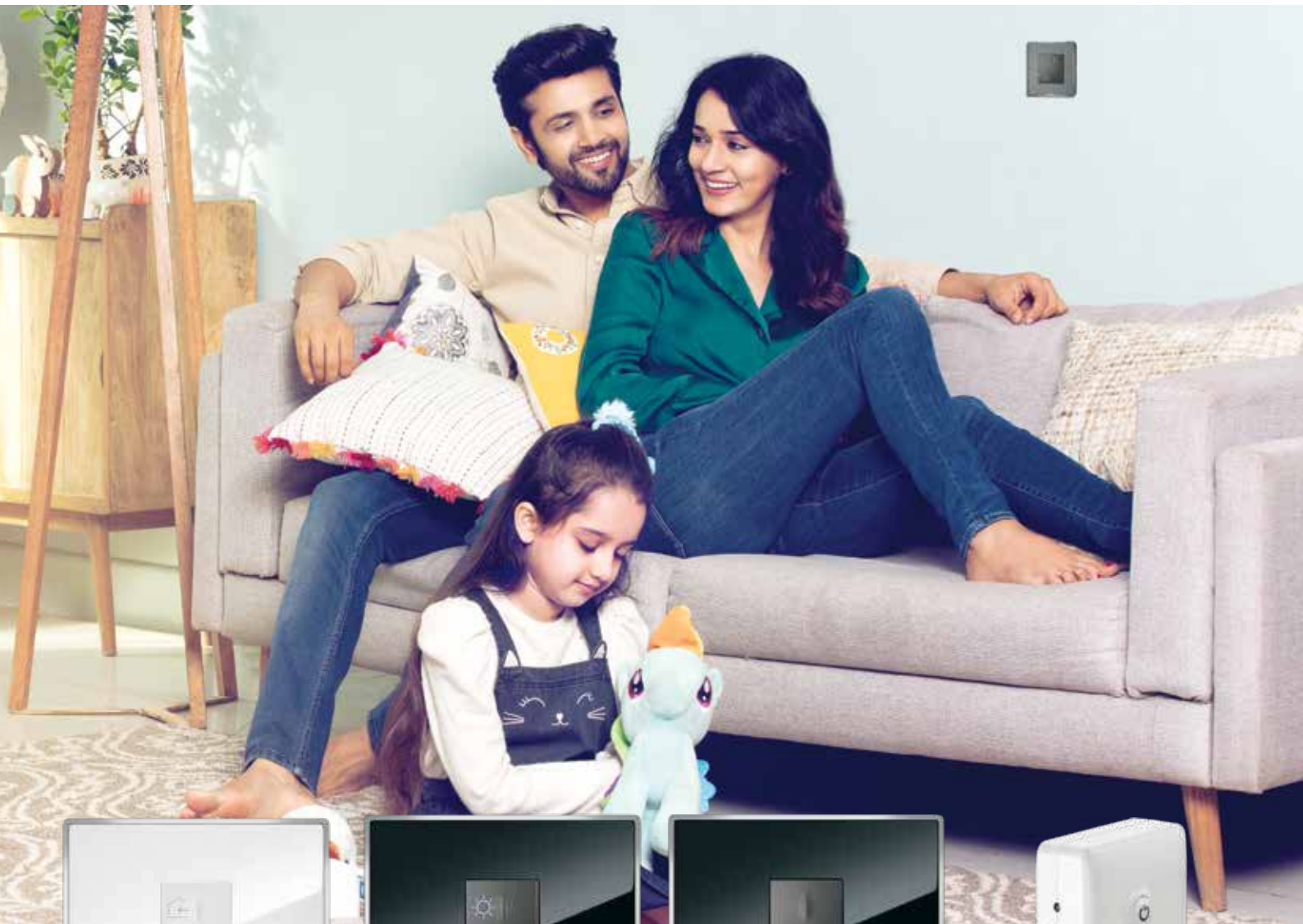

**IN WALL MASTER
HOME
IN/AWAY - 1M**



**IN WALL MASTER
WAKE UP/SLEEP -
1M**



**IN WALL WIRELESS
SHUTTER SWITCH
- 1M**



**16A SMART MOBILE
PLUG**

Myrius™ connected homes - white mechanism

Cat.Nos	Description	MRP* ₹ / Unit	Pack
---------	-------------	------------------	------

Connected light switches

6793 59	Connected Switch - with Neutral - Wired - 1 Module - White	9050	1/5/50
6793 60	Connected Switch - without Neutral - with Dimmer Option - Wired - 2 Module - White	11794	1/5/50
6793 70	Connected Switch Dimmer - with Neutral - 150 Watts - 1 Module - White	7234	1/5/50
6793 71	Connected Switch Dimmer - with Neutral - Wired - 2 Module - White	11700	1/5/20

Connected outlets

6793 67	16A - Connected Socket Module - 1 Module - White	9292	1/5/50
---------	--	------	--------

Smart plug

6793 90	6A - Smart Mobile Plug	8450	5/20
6793 91	16A - Smart Mobile Plug	9100	5/21

Connected curtain/roller blind switches

6793 61	Connected Curtain/Roller Blind Switch - Wired - 1 Module - White	9556	1/5/50
---------	--	------	--------

Connected step fan controller

6793 68	Connected Step Fan Controller - with Neutral - 100W - 2 Module - White	6954	1/5/50
---------	--	------	--------

Connected gateway pack

6793 66	Connected Gateway + Master Home/Away Wireless Switch - Wired - 2 Module - White	19330	1/5/20
---------	---	-------	--------

Connected wireless controls

6793 62	Connected Wireless Light Switch - 2 Module - White	4256	1/5/30
6793 64	Connected Curtain/Roller Blind Wireless Switch - 2 Module - White	4798	1/5/30
6793 73	2G - Wireless Switch - 2 Module - White	4286	1/5/30

Connected wireless scene switches

6793 63	Connected Home/Away Wireless Master Switch - 2 Module - White	4574	1/5/30
6793 65	Connected Wake Up/Sleep Wireless Scenario Control Switch - 2 Module - White	4986	1/5/30
6793 69	Connected Wireless 4 Scenario Control Switch - 2 Module - White	5436	1/5/30

IN wall wireless switch

6793 72	In Wall Wireless Light Switch - 1 Module - White	3722	1/5/20
6793 94	In Wall Wireless Shutter Switch - 1 Module - White	4292	1/5/20
6793 92	In Wall Home/Away Wireless Switch - 1 Module - White	4356	1/5/20
6793 96	In Wall Wake Up/Sleep Wireless Switch - 1 Module - White	4356	1/5/20

Myrius™ connected homes - charcoal grey mechanism

Cat.Nos	Description	MRP* ₹ / Unit	Pack
---------	-------------	------------------	------

Connected light switches

6793 74	Connected Switch - with Neutral - Wired - 1 Module - Charcoal Grey	10410	1/5/50
6793 75	Connected Switch - without Neutral - with Dimmer Option - Wired - 2 Module - Charcoal Grey	13566	1/5/50
6793 85	Connected Switch Dimmer - with Neutral - 150 Watts - 1 Module - Charcoal Grey	8318	1/5/20
6793 86	Connected Switch Dimmer - with Neutral - Wired - 2 Module - Charcoal Grey	13454	1/5/20

Connected outlets

6793 82	16A - Connected Socket Module - 1 Module - Charcoal Grey	10688	1/5/50
---------	--	-------	--------

Connected curtain/roller blind switches

6793 76	Connected Curtain/Roller Blind Switch - Wired - 1 Module - Charcoal Grey	10992	1/5/50
---------	--	-------	--------

Connected step fan controller

6793 83	Connected Step Fan Controller - with Neutral - 100W - 2 Module - Charcoal Grey	7996	1/5/50
---------	--	------	--------

Connected gateway pack

6793 81	Connected Gateway + Home/Away Wireless Switch - Wired - 2 Module - Charcoal Grey	22224	1/5/20
---------	--	-------	--------

Connected wireless controls

6793 77	Connected Wireless Light Switch - 2 Module - Charcoal Grey	4896	1/5/30
6793 79	Connected Curtain/Roller Blind Wireless Switch - 2 Module - Charcoal Grey	5182	1/5/30
6793 88	2G - Wireless Switch - 2 Module - Charcoal Grey	4926	1/5/30

Connected wireless scene switches

6793 78	Connected Home/Away Wireless Master Switch - 2 Module - Charcoal Grey	5602	1/5/30
6793 80	Connected Wake Up/Sleep Wireless Scenario Control Switch - 2 Module - Charcoal Grey	5732	1/5/30
6793 84	Connected Wireless 4 Scenario Control Switch - 2 Module - Charcoal Grey	6254	1/5/30

Micro module switch

6793 89	Connected Micro Module Switch - with Neutral - Black	6638	1/5/50
---------	--	------	--------

* MRP - Maximum Retail Price Inclusive of all taxes including GST.
■ Price available on request

Bold Cat.Nos are products normally available with Legrand (India) Stockists. Cat.Nos that are not bold - delivery within 4 - 8 weeks from the date of order. Bold packing quantity is our mandatory packing. Orders to be placed by Legrand (India) Stockist in multiples of the same.

Myrius™ cover plates

Cat.Nos	Description	MRP ₹ / Unit	Pack
---------	-------------	--------------------	------

IN wall wireless switch

6793 87	In Wall Wireless Light Switch - 1 Module - Charcoal Grey	4280	1/5/20
6793 95	In Wall Wireless Shutter Switch - 1 Module - Charcoal Grey	4934	1/5/20
6793 93	In Wall Home/Away Wireless Switch - 1 Module - Charcoal Grey	5010	1/5/20
6793 97	In Wall Wake Up/Sleep Wireless Switch - 1 Module - Charcoal Grey	5010	1/5/20

Cover plate

Plate frame white

6795 01	Cover Plate with Support Frame - 1 Module - Classic White	198	20/200
6795 02	Cover Plate with Support Frame - 2 Module - Classic White	206	20/200
6795 03	Cover Plate with Support Frame - 3 Module - Classic White	220	10/100
6795 04	Cover Plate with Support Frame - 4 Module - Classic White	244	10/100
6795 06	Cover Plate with Support Frame - 6 Module - Classic White	424	5/50
6795 08	Cover Plate with Support Frame - 8 Module - Classic White	464	5/50
6795 09	Cover Plate with Support Frame - 2*4 Module - Classic White	590	5/25
6795 10	Cover Plate with Support Frame - 9 Module - Classic White	622	5/50
6795 12	Cover Plate with Support Frame - 12 Module - Classic White	706	10
6795 16	Cover Plate with Support Frame - 16 Module - Classic White	822	10
6795 18	Cover Plate with Support Frame - 18 Module - Classic White	942	10

Myrius™ cover plates

Cat.Nos	Description	MRP ₹ / Unit	Pack
---------	-------------	--------------------	------

Plate frame ice white

6795 21	Cover Plate with Support Frame - 1 Module - Ice White	276	1/5/30
6795 22	Cover Plate with Support Frame - 2 Module - Ice White	292	1/5/30
6795 23	Cover Plate with Support Frame - 3 Module - Ice White	310	1/20
6795 24	Cover Plate with Support Frame - 4 Module - Ice White	332	1/20
6795 26	Cover Plate with Support Frame - 6 Module - Ice White	598	1/10
6795 28	Cover Plate with Support Frame - 8 Module - Ice White	652	1/10
6795 29	Cover Plate with Support Frame - 2*4 Module - Ice White	818	1/5
6795 32	Cover Plate with Support Frame - 12 Module - Ice White	992	1/5
6795 36	Cover Plate with Support Frame - 16 Module - Ice White	1156	1/5
6795 38	Cover Plate with Support Frame - 18 Module - Ice White	1326	1/5

Plate frame ice black

6795 41	Cover Plate with Support Frame - 1 Module - Ice Black	276	1/5/30
6795 42	Cover Plate with Support Frame - 2 Module - Ice Black	292	1/5/30
6795 43	Cover Plate with Support Frame - 3 Module - Ice Black	310	1/20
6795 44	Cover Plate with Support Frame - 4 Module - Ice Black	332	1/20
6795 46	Cover Plate with Support Frame - 6 Module - Ice Black	598	1/10
6795 48	Cover Plate with Support Frame - 8 Module - Ice Black	652	1/10
6795 49	Cover Plate with Support Frame - 2*4 Module - Ice Black	818	1/5
6795 52	Cover Plate with Support Frame - 12 Module - Ice Black	992	1/5
6795 56	Cover Plate with Support Frame - 16 Module - Ice Black	1156	1/5
6795 58	Cover Plate with Support Frame - 18 Module - Ice Black	1326	1/5

* MRP - Maximum Retail Price Inclusive of all taxes including GST.

■ To be Introduced Shortly

(1) Supplied with white plate

■ Price available on request

Bold Cat.Nos are products normally available with Legrand (India) Stockists. Cat.Nos that are not bold - delivery within 4 - 8 weeks from the date of order. Bold packing quantity is our mandatory packing. Orders to be placed by Legrand (India) Stockist in multiples of the same.

Myrius™ cover plates



Cat.Nos	Description	MRP* ₹ / Unit	Pack
Plate frame charcoal grey			
6797 01	Cover Plate with Support Frame - 1 Module - Charcoal Grey	240	20/200
6797 02	Cover Plate with Support Frame - 2 Module - Charcoal Grey	252	20/200
6797 03	Cover Plate with Support Frame - 3 Module - Charcoal Grey	272	10/100
6797 04	Cover Plate with Support Frame - 4 Module - Charcoal Grey	294	10/100
6797 06	Cover Plate with Support Frame - 6 Module - Charcoal Grey	522	5/50
6797 08	Cover Plate with Support Frame - 8 Module - Charcoal Grey	570	5/50
6797 09	Cover Plate with Support Frame - 2*4 Module - Charcoal Grey	722	5/25
6797 10	Cover Plate with Support Frame - 9 Module - Charcoal Grey	776	5/50
6797 12	Cover Plate with Support Frame - 12 Module - Charcoal Grey	866	1/10
6797 16	Cover Plate with Support Frame - 16 Module - Charcoal Grey	1004	1/10
6797 18	Cover Plate with Support Frame - 18 Module - Charcoal Grey	1154	1/10

Plate frame pearl champagne

6795 61	Cover Plate with Support Frame - 1 Module - Pearl Champagne	376	1/5/30
6795 62	Cover Plate with Support Frame - 2 Module - Pearl Champagne	398	1/5/30
6795 63	Cover Plate with Support Frame - 3 Module - Pearl Champagne	422	1/20
6795 64	Cover Plate with Support Frame - 4 Module - Pearl Champagne	458	1/20
6795 66	Cover Plate with Support Frame - 6 Module - Pearl Champagne	818	1/10
6795 68	Cover Plate with Support Frame - 8 Module - Pearl Champagne	892	1/10
6795 69	Cover Plate with Support Frame - 2*4 Module - Pearl Champagne	1118	1/5
6795 72	Cover Plate with Support Frame - 12 Module - Pearl Champagne	1352	1/5
6795 76	Cover Plate with Support Frame - 16 Module - Pearl Champagne	1572	1/5
6795 78	Cover Plate with Support Frame - 18 Module - Pearl Champagne	1810	1/5

* MRP - Maximum Retail Price Inclusive of all taxes including GST.
 ■ Price available on request

Myrius™ cover plates

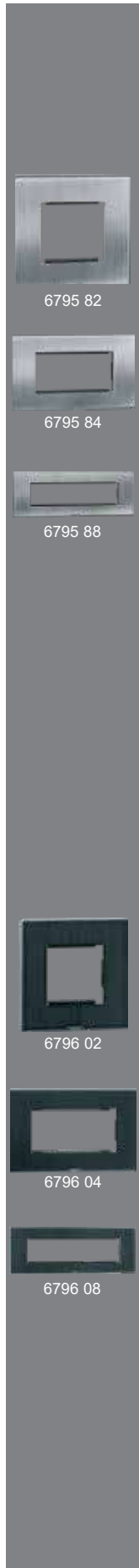

Cat.Nos	Description	MRP* ₹ / Unit	Pack
Plate frame sonic silver			
6795 81	Cover Plate with Support Frame - 1 Module - Sonic Silver	376	1/5/30
6795 82	Cover Plate with Support Frame - 2 Module - Sonic Silver	398	1/5/30
6795 83	Cover Plate with Support Frame - 3 Module - Sonic Silver	422	1/20
6795 84	Cover Plate with Support Frame - 4 Module - Sonic Silver	458	1/20
6795 86	Cover Plate with Support Frame - 6 Module - Sonic Silver	818	1/10
6795 88	Cover Plate with Support Frame - 8 Module - Sonic Silver	892	1/10
6795 89	Cover Plate with Support Frame - 2*4 Module - Sonic Silver	1118	1/5
6795 92	Cover Plate with Support Frame - 12 Module - Sonic Silver	1352	1/5
6795 96	Cover Plate with Support Frame - 16 Module - Sonic Silver	1572	1/5
6795 98	Cover Plate with Support Frame - 18 Module - Sonic Silver	1810	1/5

Plate frame dark fade

6796 01	Cover Plate with Support Frame - 1 Module - Dark Fade	376	1/5/30
6796 02	Cover Plate with Support Frame - 2 Module - Dark Fade	398	1/5/30
6796 03	Cover Plate with Support Frame - 3 Module - Dark Fade	422	1/20
6796 04	Cover Plate with Support Frame - 4 Module - Dark Fade	458	1/20
6796 06	Cover Plate with Support Frame - 6 Module - Dark Fade	818	1/10
6796 08	Cover Plate with Support Frame - 8 Module - Dark Fade	892	1/10
6796 09	Cover Plate with Support Frame - 2*4 Module - Dark Fade	1118	1/5
6796 12	Cover Plate with Support Frame - 12 Module - Dark Fade	1352	1/5
6796 16	Cover Plate with Support Frame - 16 Module - Dark Fade	1572	1/5
6796 18	Cover Plate with Support Frame - 18 Module - Dark Fade	1810	1/5

Bold Cat.Nos are products normally available with Legrand (India) Stockists. Cat.Nos that are not bold - delivery within 4 - 8 weeks from the date of order. Bold packing quantity is our mandatory packing. Orders to be placed by Legrand (India) Stockist in multiples of the same.

Myrius™ cover plates

Cat.Nos	Description	MRP ₹ / Unit	Pack
---------	-------------	--------------------	------

Plate frame interlude

6796 21	Cover Plate with Support Frame - 1 Module - Interlude	496	1/5/30
6796 22	Cover Plate with Support Frame - 2 Module - Interlude	520	1/5/30
6796 23	Cover Plate with Support Frame - 3 Module - Interlude	558	1/20
6796 24	Cover Plate with Support Frame - 4 Module - Interlude	604	1/20
6796 26	Cover Plate with Support Frame - 6 Module - Interlude	1082	1/10
6796 28	Cover Plate with Support Frame - 8 Module - Interlude	1178	1/10
6796 29	Cover Plate with Support Frame - 2*4 Module - Interlude	1476	1/5
6796 32	Cover Plate with Support Frame - 12 Module - Interlude	1782	1/5
6796 36	Cover Plate with Support Frame - 16 Module - Interlude	2082	1/5
6796 38	Cover Plate with Support Frame - 18 Module - Interlude	2386	1/5

Plate frame trinity

6796 41	Cover Plate with Support Frame - 1 Module - Trinity	496	1/5/30
6796 42	Cover Plate with Support Frame - 2 Module - Trinity	520	1/5/30
6796 43	Cover Plate with Support Frame - 3 Module - Trinity	558	1/20
6796 44	Cover Plate with Support Frame - 4 Module - Trinity	604	1/20
6796 46	Cover Plate with Support Frame - 6 Module - Trinity	1082	1/10
6796 48	Cover Plate with Support Frame - 8 Module - Trinity	1178	1/10
6796 49	Cover Plate with Support Frame - 2*4 Module - Trinity	1476	1/5
6796 52	Cover Plate with Support Frame - 12 Module - Trinity	1782	1/5
6796 56	Cover Plate with Support Frame - 16 Module - Trinity	2082	1/5
6796 58	Cover Plate with Support Frame - 18 Module - Trinity	2386	1/5

Myrius™ cover plates

Cat.Nos	Description	MRP ₹ / Unit	Pack
---------	-------------	--------------------	------

Plate frame luminar

6796 61	Cover Plate with Support Frame - 1 Module - Luminar	496	1/5/30
6796 62	Cover Plate with Support Frame - 2 Module - Luminar	520	1/5/30
6796 63	Cover Plate with Support Frame - 3 Module - Luminar	558	1/20
6796 64	Cover Plate with Support Frame - 4 Module - Luminar	604	1/20
6796 66	Cover Plate with Support Frame - 6 Module - Luminar	1082	1/10
6796 68	Cover Plate with Support Frame - 8 Module - Luminar	1178	1/10
6796 69	Cover Plate with Support Frame - 2*4 Module - Luminar	1476	1/5
6796 72	Cover Plate with Support Frame - 12 Module - Luminar	1782	1/5
6796 76	Cover Plate with Support Frame - 16 Module - Luminar	2082	1/5
6796 78	Cover Plate with Support Frame - 18 Module - Luminar	2386	1/5

Plate frame stellar

6796 81	Cover Plate with Support Frame - 1 Module - Stellar	496	1/5/30
6796 82	Cover Plate with Support Frame - 2 Module - Stellar	520	1/5/30
6796 83	Cover Plate with Support Frame - 3 Module - Stellar	558	1/20
6796 84	Cover Plate with Support Frame - 4 Module - Stellar	604	1/20
6796 86	Cover Plate with Support Frame - 6 Module - Stellar	1082	1/10
6796 88	Cover Plate with Support Frame - 8 Module - Stellar	1178	1/10
6796 89	Cover Plate with Support Frame - 2*4 Module - Stellar	1476	1/5
6796 92	Cover Plate with Support Frame - 12 Module - Stellar	1782	1/5
6796 96	Cover Plate with Support Frame - 16 Module - Stellar	2082	1/5
6796 98	Cover Plate with Support Frame - 18 Module - Stellar	2386	1/5

* MRP - Maximum Retail Price Inclusive of all taxes including GST.

■ Price available on request

■ Suitable only for wireless switch,

Bold Cat.Nos are products normally available with Legrand (India) Stockists. Cat.Nos that are not bold - delivery within 4 - 8 weeks from the date of order. **Bold packing quantity** is our mandatory packing. Orders to be placed by Legrand (India) Stockist in multiples of the same.

Myrius™ cover plates

Cat.Nos	Description	MRP* ₹ / Unit	Pack
Cover plates without frame			
6795 05	Cover Plate without Frame - 2 Module - White	126	1/5/50
6795 25	Cover Plate without Frame - 2 Module - Ice White	274	1/5/50
6795 45	Cover Plate without Frame - 2 Module - Ice Black	274	1/5/50
6795 65	Cover Plate without Frame - 2 Module - Pearl Champagne	378	1/5/50
6795 85	Cover Plate without Frame - 2 Module - Sonic Silver	378	1/5/50
6796 05	Cover Plate without Frame - 2 Module - Dark Fade	378	1/5/50
6796 25	Cover Plate without Frame - 2 Module - Interlude	504	1/5/30
6796 45	Cover Plate without Frame - 2 Module - Trinity	504	1/5/30
6796 65	Cover Plate without Frame - 2 Module - Luminar	504	1/5/50
6796 85	Cover Plate without Frame - 2 Module - Stellar	504	1/5/50

Accessory

0648 71	Pack of 3*4 Extra Removable Stickers for Fixing A Wireless Control	806	1/25
---------	--	-----	------

* MRP - Maximum Retail Price Inclusive of all taxes including GST.
 ■ Price available on request

Myrius™ cover plates

Cat.Nos	Description	MRP* ₹ / Unit	Pack
Ice graphite cover plates with support frame			
6797 21	Cover Plate - 1 Module - Ice Graphite	276	1/5/30
6797 22	Cover Plate - 2 Module - Ice Graphite	292	1/5/30
6797 23	Cover Plate - 3 Module - Ice Graphite	310	1/20
6797 24	Cover Plate - 4 Module - Ice Graphite	332	1/20
6797 26	Cover Plate - 6 Module - Ice Graphite	598	1/10
6797 28	Cover Plate - 8 Module - Horizontal - Ice Graphite	652	1/10
6797 29	Cover Plate - 2*4 Module - Vertical - Ice Graphite	820	1/5
6797 32	Cover Plate - 12 Module - Ice Graphite	990	1/5
6797 36	Cover Plate - 16 Module - Ice Graphite	1154	1/5
6797 38	Cover Plate - 18 Module - Ice Graphite	1326	1/5

NEW!



6797 23



6797 32

Bold Cat.Nos are products normally available with Legrand (India) Stockists. Cat.Nos that are not bold - delivery within 4 - 8 weeks from the date of order. Bold packing quantity is our mandatory packing. Orders to be placed by Legrand (India) Stockist in multiples of the same.

Myrius™ cover plates

NEW!
Ice silk cover plates with support frame

Cat.Nos	Description	MRP ₹ / Unit	Pack
6797 41	Cover Plate - 1 Module - Ice Silk	276	1/5/30
6797 42	Cover Plate - 2 Module - Ice Silk	292	1/5/30
6797 43	Cover Plate - 3 Module - Ice Silk	310	1/20
6797 44	Cover Plate - 4 Module - Ice Silk	332	1/20
6797 46	Cover Plate - 6 Module - Ice Silk	598	1/10
6797 48	Cover Plate - 8 Module - Horizontal - Ice Silk	652	1/10
6797 49	Cover Plate - 2*4 Module - Vertical - Ice Silk	820	1/5
6797 62	Cover Plate - 12 Module - Ice Silk	990	1/5
6797 56	Cover Plate - 16 Module - Ice Silk	1154	1/5
6797 68	Cover Plate - 18 Module - Ice Silk	1326	1/5



6797 43

Myrius™

REGULAR



The Myrius's range of plates is crafted with unique features & flawless designs, it perfectly defines aestheticism. These minimalistic and flawless designs are available in neutral tones of grainy matte black and glossy white to suit any décor.



Black Beauty

A mystic black shade with a grainy matte finish truly complements any décor.

Snowy White

Its gleaming white shade and a perfect glossy finish creates a soothing décor.



MORE AESTHETICS

Flat, sleek and smooth, Myrius with its curved edges gives it a distinct and appealing look to everyone. Moreover, its minimalistic design makes it look absolutely stunning and desirable. But what makes Myrius truly beautiful is a classic black and white shade that offers an aura of comfort and timelessness.



Fan Regulator

- In-built safety capacitor that prevents from catching fire
- ISI marked fan regulator



Motor Starter

- Complete protection against overload
- Aesthetically appealing
- For ACs/Geysers etc.



Skirting light

- Fitted into the walls at skirting level
- Provides a dim lighting
- Creates a path light during night
- Uses LEDs that saves energy



Remote control switch for light and fan

- Can control 4 lights & 1 fan
- 10 different speed options for fan
- Night lamp on product panel with manual operation option for all functions

Myrius™

REGULAR



Myrius range of wiring accessories is a classic creation to increase the customer's comfort and improve the work environment. This wide range of innovative products offers solutions for residential, commercial and hospitality projects, thus making it a range that caters to everyone's needs.



Fan regulator



Light Marking



Telephone Socket



AV Connector



RJ 45 Data Socket

Myrius™
Regular
Anti-bacterial



Projector connector



Key Fob Switch



Do not disturb Switch



Shaver socket



TV socket



Modular MCB

Myrius™ Regular

white- mechanism

Cat.Nos	Description	MRP* ₹ / Unit	Pack
---------	-------------	------------------	------

Switches – 6A - 230V AC

6730 00	6A - Switch - 1 Way - 1 Module	158	1/20/200
6730 01	6A - Switch - 2 Way - 1 Module	268	1/20/200
6730 02	6A - Switch - 1 Way - with Indicator - 1 Module	248	1/20/200
6730 03	6A - Switch - 1 Way - with "Light" Marking - 1 Module	212	1/20/200
6730 04	6A - Switch - 1 Way - with "Fan" Marking - 1 Module	220	1/20/200

Switches – 10A - 230V AC

6730 05	10A - Switch - 1 Way - 2 Module	318	1/10/100
6730 06	10A - Switch - 2 Way - 2 Module	370	1/10/100
6730 17	10A - Intermediate Switch - 230V - 2 Module	2080	1/10/100
6730 07	10A - Switch - 1 Way - with Indicator - 2 Module	392	1/10/100

Switches – 16A - 230V AC

6730 08	16A - Switch - 1 Way - 1 Module	362	1/20/200
6730 09	16A - Switch - 2 Way - 1 Module	418	1/20/200
6730 10	16A - Switch - 1 Way - with Indicator - 1 Module	438	1/20/200

Switches – 20A - 230V AC

6730 11	20A - Switch - 1 Way - 1 Module	476	1/20/200
6730 12	20A - Switch - DP - 1 Way - 2 Module	720	1/10/100
6730 13	20A - Switch - DP - 1 Way - with Indicator - 2 Module	766	1/10/100
6730 14	20A - Switch - 2 Way - 2 Module	802	1/10/100

Switches – 25A - 230V AC

6730 15	25A - Switch - SP - 1 Way - with Indicator - 1 Module	530	1/20/200
---------	---	-----	----------

Switches – 32A - 230V AC

6730 16	32A - Switch - DP - with Indicator - 2 Module	1242	1/10/100
---------	---	------	----------

Myrius™ Regular

white- mechanism

Cat.Nos	Description	MRP* ₹ / Unit	Pack
---------	-------------	------------------	------

Push buttons

6730 18	6A - Push Button - SP - 1 Module	310	1/20/200
6730 19	6A - Push Button - SP - with Indicator - 1 Module	398	1/20/200
6730 20	6A - Bell Push - 1 Module	298	1/20/200
6730 21	6A - Bell Push - with Indicator - 1 Module	392	1/20/200
6730 22	6A - Bell Push - 2 Module	450	1/10/100
6730 23	6A - Bell Push - with Indicator - 2 Module	530	1/10/100

Accessory for switch with indicator

6732 44	Lamp for Switches/Push Buttons	74	5/50
---------	--------------------------------	----	------

Indian standard sockets

6731 86	6A - Socket - with Shutter - 3 Pin - ISI - 2 Module	240	1/20/200
6730 45	6/16A - Socket - with Shutter - ISI - 2 Module	544	1/10/100
6730 83	6/16A - Socket - with Shutter - ISI - 3 Module	652	1/5/50
6730 42	16A - Switched Socket - with Shutter - 3 Pin - 3 Module	1368	1/5/50
6730 47	25A - Socket - with Shutter - 2 Module	674	1/10/100

Dimmer and fan regulator

6730 24	Rotary Dimmer - 400 Watts - 1 Module	1326	5/50
6730 25	Rotary Dimmer - 650 Watts - 3 Module	2790	1/10
6730 26	Compact Fluorescent Lamp Dimmer - 2 Module	4360	1/10
6730 27	Fan Step Regulator - 100 Watts - ISI - 1 Module	1024	5/50
6730 29	Fan Step Regulator - 100 Watts - ISI - 2 Module	1178	10/100
6730 28	Fan Step Regulator - 120 Watts - ISI - 2 Module	1266	10/100
6730 77	Fan Step Regulator - for Energy Saving Fans - 2 Module	1240	10/100

Emergency light

0785 12	Emergency Light Unit - 2 Module	6434	1/1
---------	---------------------------------	------	-----

Indicators

0785 73	Triangular Bulkhead - Blue - 2 Module	340	1/1
0785 71	Triangular Bulkhead - Colourless - 2 Module	340	1/1
0785 72	Triangular Bulkhead - Green - 2 Module	376	1/1
0785 70	Triangular Bulkhead - 2 Module - Red	376	1/1

* MRP - Maximum Retail Price Inclusive of all taxes including GST.

Bold Cat.Nos are products normally available with Legrand (India) Stockists. Cat.Nos that are not bold - delivery within 4 - 8 weeks from the date of order. Bold packing quantity is our mandatory packing. Orders to be placed by Legrand (India) Stockist in multiples of the same.

Myrius™ Regular

white- mechanism

Cat.Nos	Description	MRP* ₹ / Unit	Pack
Skirting light			
6730 36	Skirting Light - with White LED - 3 Module	1034	1/10/100
Bell indicator			
6730 33	Bell Call Indicator - 230V - 1 Module	1430	1/20/200
Buzzer			
6730 34	Buzzer - 230V - 1 Module	1420	1/20/200
Remote unit			
6730 73	Remote Control Switch - 4 Module	10462	1/5/20
Hospitality functions			
Hotel keycard switch			
6730 37	15A - Key Card Switch - Monobloc with Plate - 2 Module	4852	1/10
6732 37	15A - Key Card Switch - Monobloc with New Plate - 2 Module	5588	1/10
6730 38	Key Fob for Key Card Switch	232	1/10/100
Hotel "DND and MMR" functions			
6730 39	External DND & MMR Control Unit - with Bell Push - 2 Module	2068	1/10/100
6730 40	Internal DND & MMR Control Unit - 2 Module	1380	1/10/100
Shaver socket			
6730 49	Shaver Socket - 120/230V - Monobloc with Plate - 4 Module	6154	1/5/20
6730 79	Shaver Socket - 120/230V - Monobloc with New Plate - 4 Module	6456	1/5/20
TV socket			
6730 50	TV Co - axial Socket - 1 Module	264	1/20/200
Data & voice socket			
6730 52	Telephone Socket - RJ11 - with Transparent Shutter - 1 Module	262	1/20/200
6730 53	Telephone Socket - Double RJ11 - with Shutter - 1 Module	404	1/20/200
6730 54	Information Socket - RJ45 - Cat 5E - UTP - Toolless Systems - 1 Module	542	1/20/200
6730 55	Information Socket - RJ45 - Cat 6 - UTP - 1 Module	849	1/20/200
6730 56	Information Socket - RJ45 - Cat 6 - UTP - 2 Module	818	1/10/100
USB chargers (IS13252 (Part 1) / IEC 60950-1)			
6731 62	USB Charger - 1500mA - Type A - 1 Module	1856	1/10/100

Myrius™ Regular

white- mechanism

Cat.Nos	Description	MRP* ₹ / Unit	Pack
Audio & video connector			
6730 57	3*Female RCA - 1 Module	3618	1/10
Sound (volume controller)			
6730 63	Suitable for 8 Ohms - 3 Watts - (RNS) Speaker - 2 Module	1728	1/10/100
Protectors and accessories			
Motor starter			
6730 30	16A - Motor Starter - 2 Module	844	1/10/100
6730 31	25A - Motor Starter - 2 Module	868	1/10/100
Modular MCB (IS : 60898-1:2002)			
6730 64	16A - SP - Modular MCB - C Curve - 1 Module	502	1/10/100
6730 65	20A - SP - Modular MCB - C Curve - 1 Module	502	1/10/100
6732 05	25A - SP - Modular MCB - C Curve - 1 Module	502	1/10/100
6732 07	32A - SP - Modular MCB - C Curve - 1 Module	502	1/10/100
Accessories			
6730 60	Cable Outlet - 8mm - 1 Module	322	1/20/200
6730 61	Blanking Plate - 1 Module	66	1/20/200
6730 62	Blanking Plate - 2 Module	78	1/10/100
0802 90	Panel Mounting Support - 1 Module	264	10/200
0802 91	Panel Mounting Support - 2 Module	276	10/200
White antibacterial- mechanism			
6730 84	6A - Switch - 1 Way - 1 Module	246	1/20/200
6730 85	6A - Switch - 2 Way - 1 Module	326	1/20/200
6730 86	6A - Bell Push - 1 Module	368	1/20/200
6730 89	16A - Switch - 1 Way - 1 Module	438	1/20/200
6730 90	16A - Switch - 2 Way - 1 Module	506	1/20/200
6730 92	Fan Regulator - 120 Watts - ISI - 2 Module	1596	10/100
6731 87	6A - Socket - 3 Pin - ISI - 2 Module	296	1/20/200
6730 95	6/16A - Socket - ISI - 3 Module	784	1/5/50
0787 00	Equipotential Socket - 1 Module - Anti - Bacterial	2014	1/10
6730 98	TV Co - axial Socket - 1 Module	326	1/20/200
6730 99	Telephone Socket - RJ11 - 1 Module	326	1/20/200
6730 81	Information Socket - RJ45 - Cat 6 - UTP - 1 Module	990	1/20/200
6730 82	Blanking Plate - 1 Module	58	1/20/200

* MRP - Maximum Retail Price Inclusive of all taxes including GST.
 • To be Introduced Shortly

Bold Cat.Nos are products normally available with Legrand (India) Stockists.
 Cat.Nos that are not bold - delivery within 4 - 8 weeks from the date of order.
 Bold packing quantity is our mandatory packing. Orders to be placed by Legrand (India) Stockist in multiples of the same.

Myrius™ Regular

white antibacterial- mechanism



Cat.Nos	Description	MRP* ₹ / Unit	Pack
Antibacterial accessories			
6732 45	Cover Plate with Support Frame - 1 Module	242	20/200
6732 46	Cover Plate with Support Frame - 2 Module	276	20/200
6732 47	Cover Plate with Support Frame - 3 Module	310	10/100
6732 48	Cover Plate with Support Frame - 4 Module	334	10/100
6732 49	Cover Plate with Support Frame - Horizontal - 8 Module	642	5/50
6732 50	Cover Plate with Support Frame - (4*2) 8 Module	810	5/25
6732 52	Cover Plate with Support Frame - 16 Module	1122	1/10

Myrius™ Regular

black- mechanism

Switches – 6A - 230V AC

6731 00	6A - Switch - 1 Way - 1 Module	200	1/20/200
6731 01	6A - Switch - 2 Way - 1 Module	308	1/20/200
6731 02	6A - Switch - 1 Way - with Indicator - 1 Module	336	1/20/200
6731 03	6A - Switch - 1 Way - with "Light" Marking - 1 Module	258	1/20/200
6731 04	6A - Switch - 1 Way - with "Fan" Marking - 1 Module	258	1/20/200

Switches – 10A - 230V AC

6731 05	10A - Switch - 1 Way - 2 Module	388	1/10/100
6731 06	10A - Switch - 2 Way - 2 Module	418	1/10/100
6731 17	10A - Intermediate Switch - 230V - 2 Module	2400	1/10/100
6731 07	10A - Switch - 1 Way - with Indicator - 2 Module	446	1/10/100

Switches – 16A - 230V AC

6731 08	16A - Switch - 1 Way - 1 Module	404	1/20/200
6731 09	16A - Switch - 2 Way - 1 Module	488	1/20/200
6731 10	16A - Switch - 1 Way - with Indicator - 1 Module	506	1/20/200

Switches – 20A - 230V AC

6731 11	20A - Switch - 1 Way - 1 Module	544	1/20/200
6731 12	20A - Switch - DP - 1 Way - 2 Module	854	1/10/100
6731 13	20A - Switch - DP - 1 Way - with Indicator - 2 Module	902	1/10/100
6731 14	20A - Switch - 2 Way - 2 Module	934	1/10/100

* MRP - Maximum Retail Price Inclusive of all taxes including GST.

Myrius™ REGULAR

ANTI-BACTERIAL

MORE FOR YOUR WELLNESS



Myrius anti-bacterial products offer anti-bacterial protection. The composition of the product contain Ag+ ions that eliminates the proliferation of bacteria on contact with the surface of the product. It has a smooth and straight design that facilitates in reducing the dust accumulation. It is self disinfecting throughout its lifespan.

- Extremely useful in agri-food premises, healthcare environments & premises with high risk in terms of people's fragility.
- Special protection for the health and hygiene market in the form of an equipotential socket for earthing devices, application to connection of hospital beds and trolleys to medical apparatus to avoid all risk of potential difference during the medical care.



Scan to know more about the product.

Myrius™ Regular

black- mechanism

Cat.Nos	Description	MRP* ₹ / Unit	Pack
---------	-------------	---------------------	------

Switches – 25A - 230V AC

6731 15	25A - Switch - SP - 1 Way - with Indicator - 1 Module	620	1/20/200
---------	---	-----	----------

Switches – 32A - 230V AC

6731 16	32A - Switch - DP - with Indicator - 2 Module	1436	1/10/100
---------	---	------	----------

Push buttons

6731 18	6A - Push Button - SP - 1 Module	358	1/20/200
---------	----------------------------------	-----	----------

6731 19	6A - Push Button - SP - with Indicator - 1 Module	452	1/20/200
---------	---	-----	----------

6731 20	6A - Bell Push - 1 Module	340	1/20/200
---------	---------------------------	-----	----------

6731 21	6A - Bell Push - with Indicator - 1 Module	452	1/20/200
---------	--	-----	----------

6731 22	6A - Bell Push - 2 Module	524	1/10/100
---------	---------------------------	-----	----------

6731 23	6A - Bell Push - with Indicator - 2 Module	620	1/10/100
---------	--	-----	----------

Accessories for switches with indicator

6732 44	Lamp for Switches/Push Buttons	74	5/50
---------	--------------------------------	----	------

Indian standard sockets

6721 03	6A - Socket - with Shutter - 3 Pin - ISI - 2 Module	270	1/20/200
---------	---	-----	----------

6731 45	6/16A - Socket - with Shutter - ISI - 2 Module	638	1/10/100
---------	--	-----	----------

6731 83	6/16A - Socket - with Shutter - ISI - 3 Module	754	1/5/50
---------	--	-----	--------

6731 42	16A - Switched Socket - with Shutter - 3 Pin - 3 Module	1590	1/5/50
---------	---	------	--------

6731 47	25A - Socket - with Shutter - 2 Module	780	1/10/100
---------	--	-----	----------

Socket - red

6730 48	16A - Switched Socket - with Shutter - 3 Module - Red	1410	1/5/50
---------	---	------	--------

Dimmers & regulators

6731 24	Rotary Dimmer - 400 Watts - 1 Module	1522	5/50
---------	--------------------------------------	------	------

6731 25	Rotary Dimmer - 650 Watts - 3 Module	3222	1/10
---------	--------------------------------------	------	------

6731 27	Fan Step Regulator - 100 Watts - ISI - 1 Module	1206	5/50
---------	---	------	------

6731 29	Fan Step Regulator - 100 Watts - ISI - 2 Module	1364	10/100
---------	---	------	--------

6731 28	Fan Step Regulator - 120 Watts - ISI - 2 Module	1498	10/100
---------	---	------	--------

6731 77	Fan Step Regulator - for Energy Saving Fans - 2 Module	1448	10/100
---------	--	------	--------

* MRP - Maximum Retail Price Inclusive of all taxes including GST.

Myrius™ Regular

black- mechanism

Cat.Nos	Description	MRP* ₹ / Unit	Pack
---------	-------------	---------------------	------

Skirting light

6731 36	Skirting Light - with White LED - 3 Module	1192	1/10/100
---------	--	------	----------

Bell indicator

6731 33	Bell Call Indicator - 230V - 1 Module	1696	1/20/200
---------	---------------------------------------	------	----------

Buzzer

6731 34	Buzzer - 230V - Sound Level 72Db At 1 Meter Distance - 1 Module	1662	1/20/200
---------	---	------	----------

Remote unit

6731 73	Remote Control Switch - 4 Module	12142	1/5/20
---------	----------------------------------	-------	--------

Hospitality functions

Hotel keycard switch

6731 37	15A - Key Card Switch - with Timedelay 30 Sec. - Monobloc with Plate - 2 Module	5568	1/10
---------	---	------	------

6732 67	15A - Key Card Switch - Monobloc with New Plate - 2 Module	6502	1/10
---------	--	------	------

6730 38	Key Fob for Key Card Switch	232	1/10/100
---------	-----------------------------	-----	----------

Hotel "DND and MMR" functions

6731 39	External DND & MMR Control Unit - with Bell Push - 2 Module	2372	1/10/100
---------	---	------	----------

6731 40	Internal DND & MMR Control Unit - 2 Module	1582	1/10/100
---------	--	------	----------

Shaver socket

6731 49	Shaver Socket - 120/240V - 50/60Hz - Monobloc with Plate - 4 Module	6750	1/5/20
---------	---	------	--------

6731 79	Shaver Socket - 120/240V - Monobloc with New Plate - 4 Module	7104	1/5/20
---------	---	------	--------

TV socket

6731 50	TV Co - axial Socket - 1 Module	326	1/20/200
---------	---------------------------------	-----	----------

Data & voice socket

6731 52	Telephone Socket - RJ11 - with Transparent Shutter - 1 Module	312	1/20/200
---------	---	-----	----------

6731 53	Telephone Socket - Double RJ11 - with Shutter - 1 Module	478	1/20/200
---------	--	-----	----------

6731 54	Information Socket - RJ45 - Cat 5E - 1 Module	597	1/20/200
---------	---	-----	----------

6731 55	Information Socket - RJ45 - Cat 6 - UTP - 1 Module	909	1/20/200
---------	--	-----	----------

6731 56	Information Socket - RJ45 - Cat 6 - UTP - 2 Module	917	1/10/100
---------	--	-----	----------

Bold Cat.Nos are products normally available with Legrand (India) Stockists. Cat.Nos that are not bold - delivery within 4 - 8 weeks from the date of order. Bold packing quantity is our mandatory packing. Orders to be placed by Legrand (India) Stockist in multiples of the same.

Myrius™ Regular

plates with frame

Cat.Nos	Description	MRP* ₹ / Unit	Pack
---------	-------------	------------------	------

USB chargers (IS13252 (Part 1) / IEC 60950-1)

6731 72	USB Charger - 1500mA - Type A - 1 Module	2138	1/10/100
---------	--	------	----------

Audio & video connector

6731 57	3*Female RCA - 1 Module	4166	1/10
---------	-------------------------	------	------

6731 58	3 Pole XLR Sockets - 2 Module	3930	1/10/100
---------	-------------------------------	------	----------

Sound

6731 63	Suitable for 8 Ohms - 3 Watts - (RNS) Speaker - 2 Module	2004	1/10/100
---------	--	------	----------

Protectors and accessories

Motor starter

6731 30	16A - Motor Starter - 2 Module	994	1/10/100
---------	--------------------------------	-----	----------

6731 31	25A - Motor Starter - 2 Module	1016	1/10/100
---------	--------------------------------	------	----------

Modular MCB (IS : 60898-1:2002)

6731 64	16A - SP - Modular MCB - C Curve - 1 Module	582	1/10/100
---------	---	-----	----------

6731 65	20A - SP - Modular MCB - C Curve - 1 Module	582	1/10/100
---------	---	-----	----------

Accessories

6731 60	Cable Outlet - 8mm - 1 Module	388	1/20/200
---------	-------------------------------	-----	----------

6731 61	Blanking Plate - 1 Module	76	1/40/400
---------	---------------------------	----	----------

Cover plates with support frames

White cover plates with support frame

6732 01	Cover Plate - 1 Module - White	238	20/200
---------	--------------------------------	-----	--------

6732 02	Cover Plate - 2 Module - White	258	20/200
---------	--------------------------------	-----	--------

6732 03	Cover Plate - 3 Module - White	272	10/100
---------	--------------------------------	-----	--------

6732 04	Cover Plate - 4 Module - White	292	10/100
---------	--------------------------------	-----	--------

6732 06	Cover Plate - 6 Module - White	524	5/50
---------	--------------------------------	-----	------

6732 08	Cover Plate - 8 Module - Horizontal - White	580	5/50
---------	---	-----	------

6732 09	Cover Plate - 2*4 Module - Vertical - White	720	5/25
---------	---	-----	------

6732 12	Cover Plate - 12 Module - White	872	1/10
---------	---------------------------------	-----	------

6732 16	Cover Plate - 16 Module - White	1008	1/10
---------	---------------------------------	------	------

6732 18	Cover Plate - 18 Module - White	1162	1/10
---------	---------------------------------	------	------

Myrius™ Regular

plates with frame

Cat.Nos	Description	MRP* ₹ / Unit	Pack
---------	-------------	------------------	------

New white cover plates with support frame*

6732 11	Cover Plate - 1 Module - New White	248	20/200
---------	------------------------------------	-----	--------

6732 42	Cover Plate - 2 Module - New White	264	20/200
---------	------------------------------------	-----	--------

6732 13	Cover Plate - 3 Module - New White	286	10/100
---------	------------------------------------	-----	--------

6732 14	Cover Plate - 4 Module - New White	302	10/100
---------	------------------------------------	-----	--------

6732 66	Cover Plate - 6 Module - New White	592	5/50
---------	------------------------------------	-----	------

6732 68	Cover Plate - 8 Module - Horizontal - New White	632	5/50
---------	---	-----	------

6732 69	Cover Plate - 2*4 Module - Vertical - New White	792	5/25
---------	---	-----	------

6732 62	Cover Plate - 12 Module - New White	960	1/10
---------	-------------------------------------	-----	------

6732 56	Cover Plate - 16 Module - New White	1118	1/10
---------	-------------------------------------	------	------

6732 58	Cover Plate - 18 Module - New White	1282	1/10
---------	-------------------------------------	------	------

Black cover plates with support frame

6732 21	Cover Plate - 1 Module - Black	410	20/200
---------	--------------------------------	-----	--------

6732 22	Cover Plate - 2 Module - Black	442	20/200
---------	--------------------------------	-----	--------

6732 23	Cover Plate - 3 Module - Black	468	10/100
---------	--------------------------------	-----	--------

6732 24	Cover Plate - 4 Module - Black	520	10/100
---------	--------------------------------	-----	--------

6732 26	Cover Plate - 6 Module - Black	902	5/50
---------	--------------------------------	-----	------

6732 28	Cover Plate - 8 Module - Horizontal - Black	1006	5/50
---------	---	------	------

6732 29	Cover Plate - 2*4 Module - Vertical - Black	1240	5/25
---------	---	------	------

6732 32	Cover Plate - 12 Module - Black	1480	1/10
---------	---------------------------------	------	------

6732 36	Cover Plate - 16 Module - Black	1736	1/10
---------	---------------------------------	------	------

6732 38	Cover Plate - 18 Module - Black	1966	1/10
---------	---------------------------------	------	------

New black cover plates with support frame

6732 31	Cover Plate - 1 Module - New Black	464	20/200
---------	------------------------------------	-----	--------

6732 82	Cover Plate - 2 Module - New Black	510	20/200
---------	------------------------------------	-----	--------

6732 33	Cover Plate - 3 Module - New Black	548	10/100
---------	------------------------------------	-----	--------

6732 34	Cover Plate - 4 Module - New Black	592	10/100
---------	------------------------------------	-----	--------

6732 86	Cover Plate - 6 Module - New Black	1044	5/50
---------	------------------------------------	------	------

6732 88	Cover Plate - 8 Module - Horizontal - New Black	1140	5/50
---------	---	------	------

6732 89	Cover Plate - 2*4 Module - Vertical - New Black	1424	5/25
---------	---	------	------

6732 92	Cover Plate - 12 Module - New Black	1714	1/10
---------	-------------------------------------	------	------

6732 96	Cover Plate - 16 Module - New Black	1998	1/10
---------	-------------------------------------	------	------

6732 98	Cover Plate - 18 Module - New Black	2254	1/10
---------	-------------------------------------	------	------



6731 63



6732 01



6732 03



6732 11



6732 42



6732 14



6732 22



6732 24



6732 82



6732 33



6732 34



6732 92

* MRP - Maximum Retail Price Inclusive of all taxes including GST.
* To be Introduced Shortly

Bold Cat.Nos are products normally available with Legrand (India) Stockists. Cat.Nos that are not bold - delivery within 4 - 8 weeks from the date of order. Bold packing quantity is our mandatory packing. Orders to be placed by Legrand (India) Stockist in multiples of the same.

Myrius™ Regular mounting boxes

Cat.Nos	Description	MRP* ₹ / Unit	Pack
---------	-------------	------------------	------

Accessories

Metal flush boxes

6890 07	Metal Flush Box - 1/2 Module	144	40
6890 08	Metal Flush Box - 3 Module	144	40
6890 09	Metal Flush Box - 4 Module	190	40
6890 10	Metal Flush Box - 6 Module	302	40
6890 42	Metal Flush Box - 8 Module	352	40
6890 31	Metal Flush Box - 4*2 Module	350	20
6890 11	Metal Flush Box - 12/16 Module	530	10
6890 12	Metal Flush Box - 18/24 Module	668	10

Plastic surface boxes

6733 02	Plastic Surface Box - 1/2 Module	92	10/50
6733 03	Plastic Surface Box - 3 Module	106	5/35
6733 04	Plastic Surface Box - 4 Module	124	5/25
6733 06	Plastic Surface Box - 6 Module	160	1/10
6733 08	Plastic Surface Box - 8 Module	238	1/5
6733 05	Plastic Surface Box - 4*2 Module	226	1/5

Metal surface boxes

6890 21	Metal Surface Box - 12 Module (2 Rows*6)	564	1/6
6890 22	Metal Surface Box - 18 Module (3 Rows*6)	594	1/4

* MRP - Maximum Retail Price Inclusive of all taxes including GST.
The new plate range will be introduced shortly.

Myrius™

Guarantee

- The Company, at its discretion, will replace products if they have any manufacturing defect within 10 years for switches (without LED lamp) and power sockets. For all other **Myrius™** wiring accessories the guarantee will be 2 years.
- The above guarantee is applicable when the devices are used in Legrand metal flush boxes. Otherwise the guarantee period will be reduced by 50%.
- The guarantee is only applicable when the products are installed as per the Company's instructions and not tampered in any manner.
- The guarantee states the Company's entire liability. It does not extend to cover consequential loss or damage or installation costs arising from defective products.

Bold Cat.Nos are products normally available with Legrand (India) Stockists. Cat.Nos that are not bold - delivery within 4 - 8 weeks from the date of order. Bold packing quantity is our mandatory packing. Orders to be placed by Legrand (India) Stockist in multiples of the same.

Mylinc™

A little touch of genius

A LITTLE TOUCH OF GENIUS

Mylinc™ is a complete range of modular wiring accessories. Switches and sockets designed and made in India, keeping everyone's requirements in mind. Whether it's safety, reliability, convenience or beauty; Mylinc™ is the smart option in modular switch design.



Remote control unit for Light and Fan



USB Charger



8 Step Fan Regulator



Modular MCB



Champagne



Silver Alu





Dark Bronze



Matt Grey



Pearl White



Motor Starter



Skirting Light 2 M



Switch 25 A with indicator

Mylinc™

A little touch of genius

A LITTLE TOUCH OF GENIUS



Screwless finish & rounded corners that add beauty to any home



Linc-Loc™ intelligent design prevents wrong fitting, misaligned switches and sockets



Laser marking safeguards against fakes



Safety feature for mishap-proof use



Indicators for correct orientation



Front Removal



Stripping Template



ISI marking



CE marking

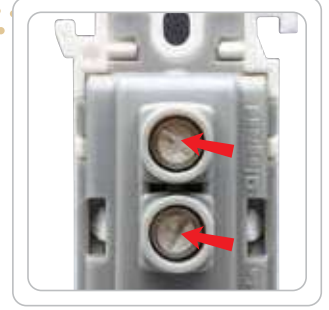

Finger-proof terminals for IP 20 protection against accidental contact

1 lac operations

with a guarantee of 100,000 operations, assuming an average switch is operated 10 times a day, this product is dependable for 27 years.

Mylic™ white- mechanism

Cat.Nos	Description	MRP* ₹ / Unit	Pack
---------	-------------	------------------	------

Switches and accessories

Switches 6A - 250V AC

6755 01	6A - Switch - SP - 1 Way - 1 Module	102	20/400
6755 02	6A - Switch - SP - 2 Way - 1 Module	196	20/200
6755 03	6A - Switch - SP - 1 Way - with Indicator - 1 Module	220	20/200

Switches - 10A - 250V AC

6755 85	10A - Switch - 1 Way - 1 Module	106	20/400
6755 93	10A - Switch - 2 Way - 1 Module	204	20/200
6755 94	10A - Switch - 1 Way - with Indicator - 1 Module	230	20/200

Switches 16A - 250V AC

6755 11	16A - Switch - SP - 1 Way - 1 Module	222	20/200
6755 12	16A - Switch - SP - 2 Way - 1 Module	280	20/200
6755 13	16A - Switch - SP - 1 Way - with Indicator - 1 Module	288	20/200

Switch 25A - 250V AC

6759 68	25A - Switch - with Indicator - 1 Module	342	10/100
---------	--	-----	--------

Switches 32A - 250V AC

6755 26	32A - Switch - DP - 1 Way - with Indicator - 2 Module	664	10/100
---------	---	-----	--------

Push buttons 6A - 250V AC

6755 04	6A - Bell Push - SP - 1 Way - 1 Module	204	20/200
6755 06	6A - Bell Push - SP - 1 Way - with Indicator - 2 Module	406	10/100

Indian standard sockets

6755 51	6A - Socket - with Shutter - 3 Pin - ISI - 2 Module	254	20/200
6755 55	6/16A - Socket - with Shutter - 3 Pin - Combine - ISI - 2 Module	390	10/100

Bell call indicator & register - 6A - 250V AC

6755 07	6A - Bell Call Indicator - SP - with Register - 1 Way - 1 Module	1110	20/200
---------	--	------	--------

Lighting modules

6755 95	Indicator Light Red - 1 Module	262	20/200
6755 96	Indicator Light Orange - 1 Module	262	20/200

Skirting light

6755 97	Skirting Light - with White LED - 3 Module	840	1/5/25
6759 76	Skirting Light - with White LED - 2 Module	562	5/50

* MRP - Maximum Retail Price Inclusive of all taxes including GST.
 ^Compatible with Atomberg (Efficio), Havells (Efficiencia neo), Orient (Aerostorm) as per 2023 fan models.

Mylic™ white- mechanism

Cat.Nos	Description	MRP* ₹ / Unit	Pack
---------	-------------	------------------	------

Dimmers and fan regulators

6755 35	Rotative Dimmer - 60/250 Watts - for Light - 2 Module	700	10/100
6755 33	Mylic Dimmer - 400 Watts - for Light - 1 Module	890	1/5/50
6759 64	Fan Regulator - 100 Watts - with 360° Rotation - 2 Module	796	10/100
6755 30	Fan Regulator - 100 Watts - Humfree - 0 - 4 Step - ISI - 2 Module	856	10/100
6755 31	Fan Regulator - 100 Watts - Humfree - 0 - 4 Step - 1 Module	640	1/5/50
6759 77	Fan Regulator - 8 Step - 2 Module	856	1/10/100
6759 78	Fan Regulator - BLDC - 2 Module^	870	10/100

Buzzer

6755 40	Mylic Buzzer	744	20/200
---------	--------------	-----	--------

Remote unit

6759 75	Remote Control Unit with Remote - for 4 Switch & Fan Load - 4 Module	3914	1/5/20
---------	--	------	--------

Hospitality function

Hotel "DND and MMR" functions

6755 56	External DND & MMR Control Unit - with Bell Push - 3 Module	396	10/50
6759 69	External DND & MMR Control Unit - with Bell Push - 2 Module	396	10/100
6755 57	Internal DND & MMR Control Unit - 2 Module	330	10/100

Hotel keycard switch

6755 60	15A Key Card Switch (MonoBloc) - 2 Module	3606	1/10
6730 38	Key Fob for Key Card Switch	232	1/10/100

Motor starter

6759 65	16A - Motor Starter - 2 Module	642	1/10/100
---------	--------------------------------	-----	----------

Modular MCB (IS : 60898-1:2002)

6759 74	16A - SP - Modular MCB - 1 Module	454	1/10/100
6756 40	20A - SP - Modular MCB - 1 Module	454	1/10/100
6756 41	25A - SP - Modular MCB - 1 Module	454	1/10/100
6756 42	32A - SP - Modular MCB - 1 Module	454	1/10/100

TV sockets

6755 46	TV Co - axial Socket - 1 Module	212	20/200
---------	---------------------------------	-----	--------

Bold Cat.Nos are products normally available with Legrand (India) Stockists. Cat.Nos that are not bold - delivery within 4 - 8 weeks from the date of order. Bold packing quantity is our mandatory packing. Orders to be placed by Legrand (India) Stockist in multiples of the same.

Mylinc™ white- mechanism

Cat.Nos	Description	MRP* ₹ / Unit	Pack
---------	-------------	------------------	------

Data and voice

6755 41	Telephone Socket - RJ11 - 1 Module	200	20/200
6755 44	Telephone Socket - Double RJ11 - 1 Module	334	20/200
6759 66	Information Socket - RJ45 - Cat 5E - with Shutter - 1 Module	487	20/200
6759 67	Information Socket - RJ45 - Cat 6 - with Shutter - 1 Module	709	20/200
6759 82	Information Socket - RJ45 - Cat 6A - with Shutter - 1 Module	808	20/200

USB chargers (IS13252(Part 1) / IEC 60950-1)

6758 20	USB Charger - 1500mA - Type A - 1 Module	1140	10/100
6755 79	USB Charger - 1500mA - Type C - 1 Module	1492	1/10/100
6755 80	USB Charger - 3000mA - Type A + C - 2 Module	2486	10/100
6757 95	USB Charger - Power Delivery - 30 Watts - Type C + C - 2 Module	5220	1/3/30
6757 96	USB Charger - Power Delivery - 45 Watts - Type C - 2 Module	6784	1/3/30

Accessories

6755 91	Cable Outlet - 8mm - 1 Module	182	20/200
6755 90	Blanking Plate - 1 Module	52	20/200
6755 92	Spare 12 Screws with Nuts	66	20/200

Modular cover plates with support frame

White cover plates with support frame

6755 61	Cover Plate - 1 Module - White	148	20/200
6755 62	Cover Plate - 2 Module - White	148	20/200
6755 63	Cover Plate - 3 Module - White	202	10/100
6755 64	Cover Plate - 4 Module - White	224	10/100
6755 66	Cover Plate - 6 Module - White	280	5/50
6755 67	Cover Plate - Horizontal - 8 Module - White	358	5/50
6755 68	Cover Plate - 2*4 Module - White	364	5/25
6755 69	Cover Plate - 9 Module - White	428	5/50
6755 72	Cover Plate - 12 Module - White	526	10
6755 73	Cover Plate - 16 Module - White	614	10
6755 78	Cover Plate - 18 Module - White	820	10

Mylinc™ matt grey- mechanism

Cat.Nos	Description	MRP* ₹ / Unit	Pack
---------	-------------	------------------	------

Switches – 6A - 250V AC

6763 01	6A - Switch - SP - 1 Way - 1 Module	122	20/200
6763 02	6A - Switch - SP - 2 Way - 1 Module	210	20/200
6763 03	6A - Switch - SP - 1 Way - with Indicator - 1 Module	248	20/200

Switches – 16A - 250V AC

6763 11	16A - Switch - SP - 1 Way - 1 Module	244	20/200
6763 12	16A - Switch - SP - 2 Way - 1 Module	302	20/200
6763 13	16A - Switch - SP - 1 Way - with Indicator - 1 Module	328	20/200

Switches – 25A - 250V AC

6763 41	25A - Switch - with Indicator - 1 Module	382	10/100
---------	--	-----	--------

Switches – 32A - 250V AC

6763 26	32A - Switch - DP - 1 Way - with Indicator - 2 Module	736	10/100
---------	---	-----	--------

Push buttons – 6A - 250V AC

6763 04	6A - Bell Push - SP - 1 Way - 1 Module	216	20/200
6763 06	6A - Bell Push - SP - 1 Way - with Indicator - 2 Module	450	10/100

Indian standard sockets

6763 27	6A - Socket - with Shutter - 3 Pin - ISI - 2 Module	280	20/200
6763 05	6/16A - Socket - with Shutter - 3 Pin - Combine - ISI - 2 Module	418	10/100

Bell call indicator & register - 6A - 250V AC

6763 07	6A - Bell Call Indicator - SP - with Register - 1 Way - 1 Module	1226	20/200
---------	--	------	--------

Lighting modules

6763 14	Indicator Light Red - 1 Module	284	20/200
6763 15	Indicator Light Orange - 1 Module	284	20/200

Skirting light

6763 16	Skirting Light - with White LED - 3 Module	922	1/5/25
6763 10	Skirting Light - with White LED - 2 Module	622	5/50

* MRP - Maximum Retail Price Inclusive of all taxes including GST.
 * To be Introduced Shortly

Bold Cat.Nos are products normally available with Legrand (India) Stockists. Cat.Nos that are not bold - delivery within 4 - 8 weeks from the date of order. Bold packing quantity is our mandatory packing. Orders to be placed by Legrand (India) Stockist in multiples of the same.

Myline™ matt grey- mechanism

Cat.Nos	Description	MRP* ₹ / Unit	Pack
Dimmers and fan regulators			
6763 17	Rotative Dimmer - 60/250 Watts - for Light - 2 Module	774	10/100
6763 18	Rotative Dimmer - 60/400 Watts - 1 Module	984	1/5/50
6763 37	Fan Regulator - 100 Watts - with 360° Rotation - 2 Module	874	10/100
6763 19	Fan Regulator - 100 Watts - Humfree - 0 - 4 Step - ISI - 2 Module	942	10/100
6763 20	Fan Regulator - 4 Step - 1 Module	700	1/5/50
6763 08	Fan Regulator - 8 Step - 2 Module	938	1/10/100
6763 09	Fan Regulator - BLDC - 2 Module [^]	956	10/100

Buzzer

6763 21	Myline Buzzer	816	20/200
---------	---------------	-----	--------

Remote unit

6763 47	Remote Control Unit with Remote - for 4 Switch & Fan Load - 4 Module	4306	1/5/20
---------	--	------	--------

Hospitality function

Hotel "DND and MMR" functions

6763 42	External DND & MMR Control Unit - with Bell Push - 2 Module	434	10/100
6763 23	Internal DND & MMR Control Unit - 2 Module	362	10/100

Hotel keycard switch

6763 24	15A Key Card Switch (MonoBloc) - 2 Module	4000	1/10
6730 38	Key Fob for Key Card Switch	232	1/10/100

Motor starter

6763 38	16A - Motor Starter - 2 Module	712	1/10/100
---------	--------------------------------	-----	----------

Modular MCB (IS : 60898-1:2002)

6763 46	16A - SP - Modular MCB - 1 Module	508	1/10/100
---------	-----------------------------------	-----	----------

TV sockets

6763 32	TV Co - axial Socket - 1 Module	220	20/200
---------	---------------------------------	-----	--------

* MRP - Maximum Retail Price Inclusive of all taxes including GST.

[^] To be Introduced Shortly

[^] Compatible with Atomberg (Efficio), Havells (Efficiencia neo), Orient (Aerostorm) as per 2023 fan models.

Myline™ matt grey- mechanism

Cat.Nos	Description	MRP* ₹ / Unit	Pack
Data and voice			
6763 33	Telephone Socket - RJ11 - 1 Module	218	20/200
6763 34	Telephone Socket - Double RJ11 - 1 Module	360	20/200
6763 39	Information Socket - RJ45 - Cat 5E - with Shutter - 1 Module	524	20/200
6763 40	Information Socket - RJ45 - Cat 6 - with Shutter - 1 Module	731	20/200
6759 83	Information Socket - RJ45 - Cat 6A - STP - 1 Module	882	20/200

USB chargers (IS13252(Part 1) / IEC 60950-1)

6758 21	USB Charger - 1500mA - Type A - 1 Module	1246	10/100
6764 79	USB Charger - 1500mA - Type C - 1 Module	1644	1/10/100
6764 80	USB Charger - 3000mA - Type A + C - 2 Module	2854	1/10/100
6766 56	USB Charger - Power Delivery - 30 Watts - Type C + C - 2 Module	5440	1/3/30
6766 57	USB Charger - Power Delivery - 45 Watts - Type C - 2 Module	7072	1/3/30

Accessories

6763 48	Cable Outlet - 8mm - 1 Module	204	20/200
6763 49	Blanking Plate - 1 Module	58	20/200

Bold Cat.Nos are products normally available with Legrand (India) Stockists. Cat.Nos that are not bold - delivery within 4 - 8 weeks from the date of order. Bold packing quantity is our mandatory packing. Orders to be placed by Legrand (India) Stockist in multiples of the same.

Myline™
cover plate

Cat.Nos	Description	MRP* ₹ / Unit	Pack
Modular cover plates with support frame			
Matt grey cover plates with support frame			
6763 50	Cover Plate - 1 Module - Matt Grey	192	20/200
6763 51	Cover Plate - 2 Module - Matt Grey	192	20/200
6763 52	Cover Plate - 3 Module - Matt Grey	270	10/100
6763 53	Cover Plate - 4 Module - Matt Grey	286	10/100
6763 54	Cover Plate - 6 Module - Matt Grey	362	5/50
6763 55	Cover Plate - 8 Module - Horizontal - Matt Grey	468	5/50
6763 56	Cover Plate - 2*4 Module - Vertical - Matt Grey	480	5/25
6763 57	Cover Plate - 9 Module - Matt Grey	556	5/50
6763 58	Cover Plate - 12 Module - Matt Grey	680	10
6763 59	Cover Plate - 18 Module - Matt Grey	1078	10

Cat.Nos	Description	MRP* ₹ / Unit	Pack
Pearl white cover plates with support frame			
6763 60	Cover Plate - 1 Module - Pearl White	182	10/100
6763 61	Cover Plate - 2 Module - Pearl White	182	10/100
6763 62	Cover Plate - 3 Module - Pearl White	242	10/100
6763 63	Cover Plate - 4 Module - Pearl White	264	10/100
6763 64	Cover Plate - 6 Module - Pearl White	348	5/50
6763 65	Cover Plate - 8 Module - Horizontal - Pearl White	438	5/50
6763 66	Cover Plate - 2*4 Module - Vertical - Pearl White	446	5/25
6763 67	Cover Plate - 9 Module - Pearl White	514	5/50
6763 68	Cover Plate - 12 Module - Pearl White	630	5/25
6763 69	Cover Plate - 18 Module - Pearl White	992	5/25

* MRP - Maximum Retail Price Inclusive of all taxes including GST.
 • To be Introduced Shortly

Myline™
cover plate

Cat.Nos	Description	MRP* ₹ / Unit	Pack
Champagne cover plates with support frame			
6763 70	Cover Plate - 1 Module - Champagne	182	10/100
6763 71	Cover Plate - 2 Module - Champagne	182	10/100
6763 72	Cover Plate - 3 Module - Champagne	242	10/100
6763 73	Cover Plate - 4 Module - Champagne	264	10/100
6763 74	Cover Plate - 6 Module - Champagne	348	5/50
6763 75	Cover Plate - 8 Module - Horizontal - Champagne	438	5/50
6763 76	Cover Plate - 2*4 Module - Vertical - Champagne	446	5/25
6763 77	Cover Plate - 9 Module - Champagne	514	5/50
6763 78	Cover Plate - 12 Module - Champagne	630	5/25
6763 79	Cover Plate - 18 Module - Champagne	992	5/25

Cat.Nos	Description	MRP* ₹ / Unit	Pack
Silver alu cover plates with support frame			
6763 80	Cover Plate - 1 Module - Silver Alu	182	10/100
6763 81	Cover Plate - 2 Module - Silver Alu	182	10/100
6763 82	Cover Plate - 3 Module - Silver Alu	242	10/100
6763 83	Cover Plate - 4 Module - Silver Alu	264	10/100
6763 84	Cover Plate - 6 Module - Silver Alu	348	5/50
6763 85	Cover Plate - 8 Module - Horizontal - Silver Alu	438	5/50
6763 86	Cover Plate - 2*4 Module - Vertical - Silver Alu	446	5/25
6763 87	Cover Plate - 9 Module - Silver Alu	514	5/50
6763 88	Cover Plate - 12 Module - Silver Alu	630	5/25
6763 89	Cover Plate - 18 Module - Silver Alu	992	5/25

Bold Cat.Nos are products normally available with Legrand (India) Stockists. Cat.Nos that are not bold - delivery within 4 - 8 weeks from the date of order. Bold packing quantity is our mandatory packing. Orders to be placed by Legrand (India) Stockist in multiples of the same.

Myline™ cover plate

Cat.Nos	Description	MRP* ₹ / Unit	Pack
Dark bronze cover plates with support frame			
6763 90	Cover Plate - 1 Module - Dark Bronze	182	10/100
6763 91	Cover Plate - 2 Module - Dark Bronze	182	10/100
6763 92	Cover Plate - 3 Module - Dark Bronze	242	10/100
6763 93	Cover Plate - 4 Module - Dark Bronze	264	10/100
6763 94	Cover Plate - 6 Module - Dark Bronze	348	5/50
6763 95	Cover Plate - 8 Module - Horizontal - Dark Bronze	438	5/50
6763 96	Cover Plate - 2*4 Module - Vertical - Dark Bronze	446	5/25
6763 97	Cover Plate - 9 Module - Dark Bronze	514	5/50
6763 98	Cover Plate - 12 Module - Dark Bronze	630	5/25
6763 99	Cover Plate - 18 Module - Dark Bronze	992	5/25



6763 91



6763 93



6763 94



6763 95



6763 97

Myline™ boxes

Cat.Nos	Description	MRP* ₹ / Unit	Pack
Modular white surrounds			
6755 81	Modular Surrounds - 1 Module - White	52	20/200
6755 82	Modular Surrounds - 2 Module - White	78	20/200
6755 83	Modular Surrounds - 3 Module - White	78	10/100
6755 84	Modular Surrounds - 4 Module - White	126	10/100
6755 86	Modular Surrounds - 6 Module - White	178	10/100
6755 89	Modular Surrounds - 9 Module - White	310	10/100
Accessories			
Metal flush boxes			
6890 07	Metal Flush Box - 1/2 Module	144	40
6890 08	Metal Flush Box - 3 Module	144	40
6890 09	Metal Flush Box - 4 Module	190	40
6890 10	Metal Flush Box - 6 Module	302	40
6890 42	Metal Flush Box - 8 Module	352	40
6890 31	Metal Flush Box - 2*4 Module	350	20
6890 29	Metal Flush Box - 9 Module	416	20
6890 11	Metal Flush Box - 12/16 Module	530	10
6890 13	Metal Flush Box - 16 Module	610	10
6890 12	Metal Flush Box - 18 Module	668	10



6755 81



6755 82



6755 83



6755 84



6755 86



6755 89



6890 07



6890 08



6890 09



6890 10



6890 31

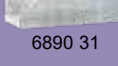

6890 29

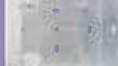

6890 11

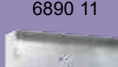

6890 13



6890 12

* MRP - Maximum Retail Price Inclusive of all taxes including GST.

^ To be Introduced Shortly

^ Compatible with Atomberg (Efficio), Havells (Efficiencia neo), Orient (Aerostorm) as per 2023 fan models.

Bold Cat.Nos are products normally available with Legrand (India) Stockists. Cat.Nos that are not bold - delivery within 4 - 8 weeks from the date of order. Bold packing quantity is our mandatory packing. Orders to be placed by Legrand (India) Stockist in multiples of the same.

Mylinec™ boxes

Cat.Nos	Description	MRP* ₹ / Unit	Pack
Plastic surface boxes			
 6733 02	Plastic Surface Box - 1/2 Module	92	10/50
 6733 03	Plastic Surface Box - 3 Module	106	5/35
 6733 04	Plastic Surface Box - 4 Module	124	5/25
6733 06	Plastic Surface Box - 6 Module	160	1/10
6733 08	Plastic Surface Box - 8 Module	238	1/5
6733 05	Plastic Surface Box - 2*4 Module	226	1/5
 6740 99	Plastic Surface Box - 9 Module	268	1/5
Metal Surface Boxes			
 6890 21	Metal Surface Box - 12 Module (2 Rows*6)	564	1/6
 6890 22	Metal Surface Box - 18 Module (3 Rows*6)	594	1/4

* MRP - Maximum Retail Price Inclusive of all taxes including GST.
 * To be Introduced Shortly

Mylinec™

A little touch of genius

A LITTLE TOUCH OF GENIUS



Guarantee

- The Company, at its discretion, will replace products if they have any manufacturing defect within 10 years for switches (without LED lamp) and power sockets. For all other **Mylinec™** wiring accessories the guarantee will be 2 years.
- The above guarantee is applicable when the devices are used in Legrand metal flush boxes. Otherwise the guarantee period will be reduced by 50%.
- The guarantee is only applicable when the products are installed as per the Company's instructions and not tampered in any manner.
- The guarantee states the Company's entire liability. It does not extend to cover consequential loss or damage or installation costs arising from defective products.

Bold Cat.Nos are products normally available with Legrand (India) Stockists.
 Cat.Nos that are not bold - delivery within 4 - 8 weeks from the date of order.
 Bold packing quantity is our mandatory packing. Orders to be placed by
 Legrand (India) Stockist in multiples of the same.

Lyncus™

Change to today

TIME TO CHANGE
TO TODAY



Today's homes need a range that mirrors their look. A modern sleek look with clean lines. A look that is chic and futuristic. Our new Lyncus range brings the aesthetic to your home, but with a subtle touch that adds character to every room

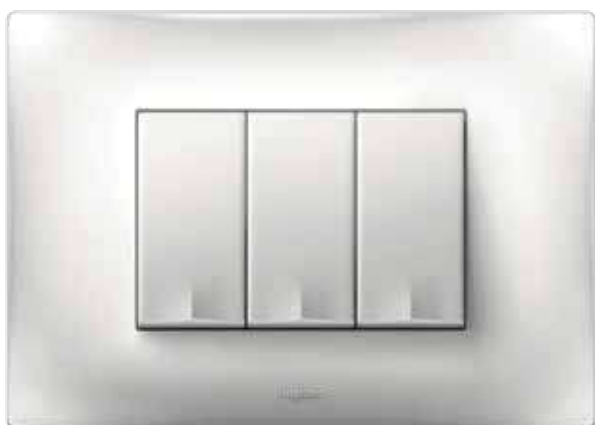

White



Chic Grey



Scan to know more about
the product.

TIME TO CHANGE
TO TODAY



RANGE



Brushed



Alu Sunset



Champagne



Matt Silver

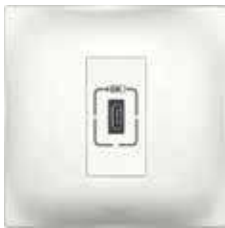

USB TYPE C



USB TYPE A + TYPE C



USB Charger Type C + C



REMOTE CONTROL UNIT



BLUETOOTH SOUND RECEIVER



6/16A socket with
shutter (ISI)



TOUCH FAN
REGULATOR



UNIVERSAL
TOUCH DIMMER



ONE WAY
TOUCH SWITCH

Lyncus™ white- mechanism

Cat.Nos	Description	MRP* ₹ / Unit	Pack
---------	-------------	------------------	------

Switches - 6A - 230V AC

6772 00	6A - Switch - 1 Way - 1 Module	90	20/200
6772 01	6A - Switch - 2 Way - 1 Module	176	20/200
6772 02	6A - Switch - 1 Way - with Indicator - 1 Module	176	10/100
6772 03	6A - Switch - 1 Way - with "Light" Marking - 1 Module	158	10/100
6772 04	6A - Switch - 1 Way - with "Fan" Marking - 1 Module	158	10/100

Switches - 10A - 230V AC

6773 01	10A - Switch - 1 Way - 1 Module	92	20/200
6773 02	10A - Switch - 2 Way - 1 Module	180	20/200
6773 07	10A - Switch - 1 Way - with Indicator - 1 Module	180	20/200
6772 05	10A - Switch - 1 Way - 2 Module	210	10/100
6772 06	10A - Switch - 2 Way - 2 Module	254	20/200
6772 07	10A - Intermediate Switch - 230V AC - 2 Module	1440	10/100
6772 08	10A - Switch - 1 Way - with Indicator - 2 Module	278	20/200

Switches - 16A - 230V AC

6772 09	16A - Switch - 1 Way - 1 Module	202	20/200
6772 10	16A - Switch - 2 Way - 1 Module	252	10/100
6772 11	16A - Switch - 1 Way - with Indicator - 1 Module	260	10/100

Switches - 20A - 230V AC

6772 12	20A - Switch - 1 Way - 1 Module	298	20/200
6772 13	20A - Switch - DP - 1 Way - 2 Module	434	10/100
6772 14	20A - Switch - DP - 1 Way - with Indicator - 2 Module	442	10/100
6772 15	20A - Switch - 2 Way - 2 Module	492	20/200

Switches - 25A - 230V AC

6772 16	25A - Switch - SP - 1 Way - with Indicator - 1 Module	308	10/100
---------	---	-----	--------

Switches - 32A - 230V AC

6772 17	32A - Switch - DP - with Indicator - 2 Module	598	1/10/100
---------	---	-----	----------

Push Button - 6A - 230V AC

6772 18	6A - Push Button - SP - 1 Module	144	20/200
6772 19	6A - Push Button - SP - with Indicator - 1 Module	206	20/200
6772 20	6A - Bell Push - 1 Module	188	20/200
6772 21	6A - Bell Push - with Indicator - 1 Module	220	20/200
6772 22	6A - Bell Push - 2 Module	252	10/100
6772 23	6A - Bell Push - with Indicator - 2 Module	372	10/100

Accessory for switch with indicator

6772 24	LED Indicator for Switches	44	20/200
---------	----------------------------	----	--------

Lyncus™ white- mechanism

Cat.Nos	Description	MRP* ₹ / Unit	Pack
---------	-------------	------------------	------

Indian standard sockets

6772 35	6A - Socket - with Shutter - 3 Pin - ISI - 2 Module	164	20/200
6772 30	6/16A - Socket - with Shutter - ISI - 2 Module	336	1/50
6772 29	6/16A - Socket - with Shutter - ISI - 3 Module	400	1/16
6772 26	16A - Switch Socket - with Shutter - 3 Pin - 3 Module	632	1/20/200
6772 32	25A - Socket - with Shutter - 2 Module	336	1/16

Dimmers and fan regulators

6772 36	Rotary Light Dimmer - 400 Watts - 1 Module	610	5/50
6772 37	Rotary Light Dimmer - 500 Watts - 2 Module	782	10/100
6772 39	Fan Regulator - 100 Watts - ISI - 1 Module	560	1/10
6772 40	Fan Regulator - 100 Watts - 360° - ISI - 2 Module	692	10/100
6772 41	Fan Regulator - 120 Watts - 360° - ISI - 2 Module	790	5/50
6772 42	Fan step Regulator - 70 Watts - ISI - 2 Module	756	1/10/100
6772 44	Fan Regulator - 8 Step - 100 Watts - ISI - 2 Module	618	10/100
6772 45	Fan Regulator - BLDC - 2 Module [^]	760	10/100

Emergency light

6772 43	Emergency Removable LED Lamp - 2 Module	2582	20/200
---------	---	------	--------

Skirting light

6772 48	Skirting Light - with LED - 3 Module	538	1/5/30
---------	--------------------------------------	-----	--------

Indicator

6772 87	Indicator Unit - with Transparent LED & Colored Labels - 1 Module	568	10/100
---------	---	-----	--------

Bell call indicator

6772 49	Bell Call Indicator - 240V - 1 Module	1064	20/200
---------	---------------------------------------	------	--------

Buzzer

6772 50	Buzzer - 230V - 1 Module	716	20/200
---------	--------------------------	-----	--------

Infrared sensors

6772 51	Infrared Sensor Switch - 400 Watts - 2 Module	1610	20/200
---------	---	------	--------

Remote unit

6772 52	Remote Control Unit - for Light & Fan - 4 Module	4140	1/10/100
6773 03	Remote Control Hand Unit	680	1/5/30

hospitality function

Hotel keycard switch

6772 53	16A - Key Card Switch - 2 Module	3364	1/10/100
6772 55	Key Fob for Key Card Switch	112	10/100

Hotel "DND and MMR" functions

6772 56	External DND & MMR Control Unit - with Bell Push - 2 Module	372	10/100
6772 57	Internal DND & MMR Control Unit - 2 Module	302	10/100

* MRP - Maximum Retail Price Inclusive of all taxes including GST.

Red Cat.Nos - new products

[^] Compatible with Atomberg (Efficio), Havells (Efficiencia neo), Orient (Aerostorm) as per 2023 fan models.

Bold Cat.Nos are products normally available with Legrand (India) Stockists. Cat.Nos that are not bold - delivery within 4 - 8 weeks from the date of order. Bold packing quantity is our mandatory packing. Orders to be placed by Legrand (India) Stockist in multiples of the same.

Lyncus™ white- mechanism

Cat.Nos	Description	MRP* ₹ / Unit	Pack
---------	-------------	------------------	------

Shaver socket

6772 58	Shaver Socket - 120/240V - MonoBlock with Plate - 2 Module	2580	20/200
---------	--	------	--------

Sockets & connectors TV sockets

6772 60	TV Co - axial Socket - 1 Module	188	20/200
---------	---------------------------------	-----	--------

Data & voice

6772 62	Telephone Socket - RJ11 - 1 Module	176	20/200
6772 63	Telephone Socket - Double RJ11 - 1 Module	286	20/200
6772 64	Information Socket - RJ45 - CAT 5 - UTP - Toolless with Shutter - 1 Module	461	20/200
6772 65	Information Socket - RJ45 - CAT 6 - UTP - toolless with shutter - 1 Module	644	20/200
6773 20	Information Socket - RJ45 - CAT6A - STP - 1 Module	818	20/200

Audio video connectors

6772 67	Preterminated Audio/Video Connector - 1 Module	1365	1/10
6772 68	Preterminated HDMI Socket - 1 Module	1677	1/10
6772 69	Preterminated Projector Connector - 1 Module	1677	1/10

Sound (Volume controller)

6772 70	Volume Controller - 2 Module	1077	20/200
---------	------------------------------	------	--------

Protectors and accessories

Motor starter

6772 71	16A - Motor Starter - 2 Module	670	1/5/50
6772 72	25A - Motor Starter - 2 Module	670	1/5/50

VSP

6772 74	Voltage Surge Protector - 230V - 1 Module	2152	20/200
---------	---	------	--------

Modular MCB (IS : 608981:2002)

6772 81	16A - SP - Modular MCB - 1 Module	442	1/10/100
6772 82	20A - SP - Modular MCB - 1 Module	442	1/10/100
6772 83	32A - SP - Modular MCB - 1 Module	442	1/10/100

Lyncus™ white- mechanism

Cat.Nos	Description	MRP* ₹ / Unit	Pack
---------	-------------	------------------	------

Electronic function

USB chargers (IS13252 (Part 1) / IEC 60950-1)

6772 91	USB Charger - 1500mA - Type A - 1 Module	1098	5/50
6772 89	USB Charger - 3000mA - Type A + C - 2 Module	2538	1/12
6772 90	USB Charger - 1500mA - Type C - 1 Module	1222	10/100
6777 51	USB Charger - 3000mA/15 Watts - Type A - 1 Module	1608	1/5/50
6777 52	USB Charger - 3000mA/15 Watts - Type A + A - 1 Module	1786	1/5/50
6777 53	USB Charger - 3000mA/15 Watts - Type A + C - 1 Module	2046	1/5/50
6777 54	USB Charger - 3000mA/15 Watts - Type C + C - 1 Module	2238	1/5/50
6777 55	USB Charger - Power Delivery - 20 Watts - Type C - 1 Module	3100	1/5/50
6777 56	USB Charger - Power Delivery - 30 Watts - Type C + C - 2 Module	5580	1/3/30
6777 57	USB Charger - Power Delivery - 45 Watts - Type C - 2 Module	6830	1/3/30
6777 58	USB Charger - Power Delivery - 63 Watts - Type C + C - 3 Module	8078	1/5/20

Loud speakers

6772 98	Loudspeaker for False Ceiling & Plaster Board - 8 Ohms - 10 Watts	2163	20/200
---------	---	------	--------

Sound diffusion

6772 99	Bluetooth Sound Diffusion - 2 Module	4767	20/200
---------	--------------------------------------	------	--------

Rotary dimmer universal

6773 04	Rotary LED Light Dimmer - 50 Watts - 1 Module	2254	1/10/120
---------	---	------	----------

Touch switches

6773 09	6A - Touch Switch - 1 Way - 2 Module - Black	3414	1/50
6773 10	6A - Touch Switch - 2 Way - 2 Module - Black	3946	1/50
6773 13	16A - Touch Switch - 1 Way - 2 Module - Black	3946	1/50
6773 06	6A - Touch Bell Push - 2 Module - Black	3414	1/50

Touch regulator & dimmer

6773 05	Touch Fan Regulator - 100 Watts - 2 Module - Black	3946	1/50
6773 15	Universal LED Touch Light Scroll Dimming - 300 Watts - 2 Module - Black	3946	1/50

Reading light

6773 16	Reading Light LED	2044	20/200
---------	-------------------	------	---------------

* MRP - Maximum Retail Price Inclusive of all taxes including GST.
 * To be Introduced Shortly
 Red Cat.Nos - new products

Bold Cat.Nos are products normally available with Legrand (India) Stockists. Cat.Nos that are not bold - delivery within 4 - 8 weeks from the date of order. Bold packing quantity is our mandatory packing. Orders to be placed by Legrand (India) Stockist in multiples of the same.

Lyncus™ white- mechanism

Cat.Nos	Description	MRP* ₹ / Unit	Pack
---------	-------------	------------------	------

Accessories

6772 75	Cable Outlet - 8mm - 1 Module	168	20/200
6772 76	Blanking Plate - 1 Module - Classic White	44	40/400
6772 77	Blanking Plate - 2 Module - Classic White	58	10/100

Chic grey- mechanism

Switches - 6A - 230V AC

6774 00	6A - Switch - 1 Way - 1 Module	108	20/200
6774 01	6A - Switch - 2 Way - 1 Module	202	20/200
6774 02	6A - Switch - 1 Way - with Indicator - 1 Module	204	10/100
6774 03	6A - Switch - 1 Way - with "Light" Marking - 1 Module	196	20/200
6774 04	6A - Switch - 1 Way - with "Fan" Marking - 1 Module	196	10/100

Switches - 10A - 230V AC

6774 05	10A - Switch - 1 Way - 2 Module	246	20/200
6774 06	10A - Switch - 2 Way - 2 Module	290	20/200
6774 07	10A - Intermediate Switch - 230V AC - 2 Module	1658	20/200
6774 08	10A - Switch - 1 Way - with Indicator - 2 Module	320	20/200

Switches - 16A - 230V AC

6774 09	16A - Switch - 1 Way - 1 Module	224	10/100
6774 10	16A - Switch - 2 Way - 1 Module	286	10/100
6774 11	16A - Switch - 1 Way - with Indicator - 1 Module	298	5/50

Switches - 20A - 230V AC

6774 12	20A - Switch - 1 Way - 1 Module	348	10/100
6774 13	20A - Switch - DP - 1 Way - 2 Module	502	1/10
6774 14	20A - Switch - DP - 1 Way - with Indicator - 2 Module	510	10/100
6774 15	20A - Switch - 2 Way - 2 Module	576	10/100

Switches - 25A - 230V AC

6774 16	25A - Switch - SP - 1 Way - with Indicator - 1 Module	358	10/100
---------	---	-----	--------

Switches - 32A - 230V AC

6774 17	32A - Switch - DP - with Indicator - 2 Module	684	1/10/100
---------	---	-----	----------

Push button - 6A - 230V AC

6774 18	6A - Push Button - SP - 1 Module	166	20/200
6774 19	6A - Push Button - SP - with Indicator - 1 Module	234	20/200
6774 20	6A - Bell Push - 1 Module	216	20/200
6774 21	6A - Bell Push - with Indicator - 1 Module	258	20/200
6774 22	6A - Bell Push - 2 Module	286	10/100
6774 23	6A - Bell Push - with Indicator - 2 Module	428	10/100

Lyncus™ chic grey- mechanism

Cat.Nos	Description	MRP* ₹ / Unit	Pack
---------	-------------	------------------	------

Indian standard sockets

6774 35	6A - Socket - with Shutter - 3 Pin - ISI - 2 Module	190	10/100
6774 30	6/16A - Socket - with Shutter - ISI - 2 Module	390	1/12
6774 29	6/16A - Socket - with Shutter - ISI - 3 Module	462	20/200
6774 32	25A - Socket - with Shutter - 2 Module	390	20/200

Dimmers and fan regulators

6774 36	Rotary Light Dimmer - 400 Watts - 1 Module	700	5/50
6774 37	Rotary Light Dimmer - 500 Watts - 2 Module	898	10/100
6774 39	Fan Regulator - 100 Watts - ISI - 1 Module	648	5/50
6774 40	Fan Regulator - 100 Watts - 360° - ISI - 2 Module	798	10/100
6774 41	Fan Regulator - 120 Watts - 360° - ISI - 2 Module	908	10/100
6774 42	Fan step Regulator - 70 Watts - ISI - 2 Module	872	1/10/100
6774 44	Fan Regulator - 8 Step - 100 Watts - 2 Module	714	10/100
6774 45	Fan Regulator - BLDC - 2 Module [^]	880	10/100

Skirting light

6774 48	Skirting Light - with LED - 3 Module	610	20/200
---------	--------------------------------------	-----	--------

Bell call indicator

6774 49	Bell Call Indicator - 240V - 1 Module	1202	20/200
---------	---------------------------------------	------	--------

Buzzer

6774 50	Buzzer - 230V - 1 Module	812	20/200
---------	--------------------------	-----	--------

Remote unit

6774 52	Remote Control Unit - for Light & Fan - 4 Module	4446	1/5/50
6773 03	Remote Control Hand Unit	680	1/5/30

hospitality function

Hotel keypad switch

6774 53	16A - Key Card Switch - 2 Module	3794	1/10/100
---------	----------------------------------	------	----------

Hotel "DND and MMR" functions

6774 56	External DND & MMR Control Unit - with Bell Push - 2 Module	428	10/100
6774 57	Internal DND & MMR Control Unit - 2 Module	340	10/100

Shaver socket

6774 58	Shaver Socket - 120/240V - MonoBlock with Plate - 2 Module	2884	20/200
---------	--	------	--------

Sockets & connectors TV sockets

6774 60	TV Co - axial Socket - 1 Module	210	20/200
---------	---------------------------------	-----	--------

* MRP - Maximum Retail Price Inclusive of all taxes including GST.

[^]To be Introduced Shortly

[^]Compatible with Atomberg (Efficio), Havells (Efficiencia neo), Orient (Aerostorm) as per 2023 fan models.

Red Cat.Nos - new products

Bold Cat.Nos are products normally available with Legrand (India) Stockists. Cat.Nos that are not bold - delivery within 4 - 8 weeks from the date of order. Bold packing quantity is our mandatory packing. Orders to be placed by Legrand (India) Stockist in multiples of the same.

Lyncus™ chic grey- mechanism

Lyncus™ plate frame

Cat.Nos	Description	MRP* ₹ / Unit	Pack
---------	-------------	---------------------	------

Cat.Nos	Description	MRP* ₹ / Unit	Pack
---------	-------------	---------------------	------

Data & voice

6774 62	Telephone Socket - RJ11 - 1 Module	198	20/200
6774 63	Telephone Socket - Double RJ11 - 1 Module	338	20/200
6774 64	Information Socket - RJ45 - Cat 5 - UTP - Toolless with Shutter - 1 Module	505	20/200
6774 65	Information Socket - RJ45 - Cat 6 - UTP - Toolless with Shutter - 1 Module	707	20/200
6773 21	Information Socket - RJ45 - CAT6A - STP - 1 Module	888	20/200

Cover plates with support frame White cover plates with support frame

6775 01	Cover Plate - 1 Module - Classic White	138	20/200
6775 02	Cover Plate - 2 Module - Classic White	138	20/200
6775 03	Cover Plate - 3 Module - Classic White	176	10/100
6775 04	Cover Plate - 4 Module - Classic White	202	10/100
6775 06	Cover Plate - 6 Module - Classic White	248	5/50
6775 08	Cover Plate - 8 Module - Horizontal - Classic White	316	5/50
6775 09	Cover Plate - 2*4 Module - Vertical - Classic White	332	5/25
6775 10	Cover Plate - 9 Module - Classic White	354	5/50
6775 12	Cover Plate - 12 Module - Classic White	462	10
6775 16	Cover Plate - 16 Module - Classic White	536	10
6776 17	Cover Plate - 16 Module - Classic White	546	10
6775 18	Cover Plate - 18 Module - Classic White	724	10

Audio video sockets

6774 67	Preterminated Audio/Video Connector - 1 Module	1576	1/10
6774 68	Preterminated HDMI Socket - 1 Module	1924	1/10
6774 69	Preterminated Projector Connector - 1 Module	1924	1/10

Sound (volume controller)

6774 70	Volume Controller - 2 Module	1242	1/10/100
---------	------------------------------	------	----------

Electronic function

USB chargers (IS13252 (Part 1) / IEC 609501)

6774 91	USB Charger - 1500mA - Type A - 1 Module	1248	10/100
6774 89	USB Charger - 3000mA - Type A + C - 2 Module	2918	1/6
6774 90	USB Charger - 1500mA - Type C - 1 Module	1408	1/10/100
6779 51	USB Charger - 3000mA/15 Watts - Type A - 1 Module	1794	1/5/50
6779 52	USB Charger - 3000mA/15 Watts - Type A + A - 1 Module	2010	1/5/50
6779 53	USB Charger - 3000mA/15 Watts - Type A + C - 1 Module	2276	1/5/50
6779 54	USB Charger - 3000mA/15 Watts - Type C + C - 1 Module	2486	1/5/50
6779 55	USB Charger - Power Delivery - 20 Watts - Type C - 1 Module	3464	1/5/50
6779 56	USB Charger - Power Delivery - 30 Watts - Type C + C - 2 Module	5826	1/3/30
6779 57	USB Charger - Power Delivery - 45 Watts - Type C - 2 Module	7180	1/3/30
6779 58	USB Charger - Power Delivery - 63 Watts - Type C + C - 3 Module	8532	1/5/20

Sound receiver

6774 99	Bluetooth Sound Diffusion - 2 Module	5482	20/200
---------	--------------------------------------	------	--------

Rotary dimmer universal

6774 24	Rotary LED Dimmer - 50 Watts - 1 Module	2856	1/120
---------	---	------	-------

Accessories

6774 75	Cable Outlet - 8mm - 1 Module	200	10/100
6774 76	Blanking Plate - 1 Module	46	40/400

Red Cat.Nos - new products

Bold Cat.Nos are products normally available with Legrand (India) Stockists. Cat.Nos that are not bold - delivery within 4 - 8 weeks from the date of order. Bold packing quantity is our mandatory packing. Orders to be placed by Legrand (India) Stockist in multiples of the same.

Lyncus™ plate frame

Cat.Nos	Description	MRP* ₹ / Unit	Pack
Chic grey cover plates with support frame			
6775 21	Cover Plate - 1 Module - Chic Grey	176	20/200
6775 22	Cover Plate - 2 Module - Chic Grey	176	20/200
6775 23	Cover Plate - 3 Module - Chic Grey	244	10/100
6775 24	Cover Plate - 4 Module - Chic Grey	258	10/100
6775 26	Cover Plate - 6 Module - Chic Grey	318	5/50
6775 28	Cover Plate - 8 Module - Horizontal - Chic Grey	434	5/50
6775 29	Cover Plate - 2*4 Module - Vertical - Chic Grey	434	5/25
6775 30	Cover Plate - 9 Module - Chic Grey	468	5/50
6775 32	Cover Plate - 12 Module - Chic Grey	606	10
6775 36	Cover Plate - 16 Module - Chic Grey	698	10
6776 37	Cover Plate - 16 Module - Chic Grey	702	1/10
6775 38	Cover Plate - 18 Module - Chic Grey	952	10







Lyncus™ plate frame

Cat.Nos	Description	MRP* ₹ / Unit	Pack
Brushed silver cover plates with support frame			
6775 41	Cover Plate - 1 Module - Brushed Silver	182	20/200
6775 42	Cover Plate - 2 Module - Brushed Silver	182	20/200
6775 43	Cover Plate - 3 Module - Brushed Silver	258	10/100
6775 44	Cover Plate - 4 Module - Brushed Silver	266	10/100
6775 46	Cover Plate - 6 Module - Brushed Silver	344	5/50
6775 48	Cover Plate - 8 Module - Horizontal - Brushed Silver	444	5/50
6775 49	Cover Plate - 2*4 Module - Vertical - Brushed Silver	444	5/25
6775 50	Cover Plate - 9 Module - Brushed Silver	486	5/50
6775 52	Cover Plate - 12 Module - Brushed Silver	638	10
6775 56	Cover Plate - 16 Module - Brushed Silver	736	10
6776 57	Cover Plate - 16 Module - Brushed Silver	746	1/10
6775 58	Cover Plate - 18 Module - Brushed Silver	1000	10

* MRP - Maximum Retail Price Inclusive of all taxes including GST.
 * To be Introduced Shortly
 Red Cat.Nos - new products



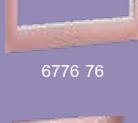











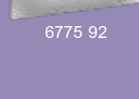

Bold Cat.Nos are products normally available with Legrand (India) Stockists.
 Cat.Nos that are not bold - delivery within 4 - 8 weeks from the date of order.
 Bold packing quantity is our mandatory packing. Orders to be placed by Legrand (India) Stockist in multiples of the same.

Lyncus™ plate frame

Cat.Nos	Description	MRP* ₹ / Unit	Pack
Alu sun set cover plates with support frame			
 6775 61	Cover Plate - 1 Module - Alu SunSet	178	20/200
 6775 62	Cover Plate - 2 Module - Alu SunSet	178	20/200
 6775 63	Cover Plate - 3 Module - Alu SunSet	244	10/100
 6775 64	Cover Plate - 4 Module - Alu SunSet	264	10/100
 6775 66	Cover Plate - 6 Module - Alu SunSet	336	5/50
 6775 68	Cover Plate - 8 Module - Horizontal - Alu SunSet	434	5/50
 6775 69	Cover Plate - 2*4 Module - Vertical - Alu SunSet	436	5/25
 6775 70	Cover Plate - 9 Module - Alu SunSet	468	5/50
 6775 72	Cover Plate - 12 Module - Alu SunSet	618	10
 6775 76	Cover Plate - 16 Module - Alu SunSet	714	10
 6776 77	Cover Plate - 16 Module - Alu SunSet	718	10
 6775 78	Cover Plate - 18 Module - Alu SunSet	980	10

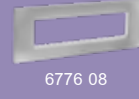
* To be Introduced Shortly
Red Cat.Nos - new products

Lyncus™ plate frame

Cat.Nos	Description	MRP* ₹ / Unit	Pack
Champagne cover plates with support frame			
 6775 81	Cover Plate - 1 Module - Champagne	178	20/200
 6775 82	Cover Plate - 2 Module - Champagne	178	20/200
 6775 83	Cover Plate - 3 Module - Champagne	244	10/100
 6775 84	Cover Plate - 4 Module - Champagne	264	10/100
 6775 86	Cover Plate - 6 Module - Champagne	336	5/50
 6775 88	Cover Plate - 8 Module - Horizontal - Champagne	434	5/50
 6775 89	Cover Plate - 2*4 Module - Vertical - Champagne	436	5/25
 6775 90	Cover Plate - 9 Module - Champagne	468	5/50
 6775 92	Cover Plate - 12 Module - Champagne	618	10
 6775 96	Cover Plate - 16 Module - Champagne	714	10
 6776 97	Cover Plate - 16 Module - Champagne	718	1/10
 6775 98	Cover Plate - 18 Module - Champagne	980	10
Matt silver cover plates with support frame			
 6776 01	Cover Plate - 1 Module - Matt Silver	178	20/200
 6776 02	Cover Plate - 2 Module - Matt Silver	178	20/200
 6776 03	Cover Plate - 3 Module - Matt Silver	244	10/100
 6776 04	Cover Plate - 4 Module - Matt Silver	264	10/100
 6776 06	Cover Plate - 6 Module - Matt Silver	336	5/50
 6776 08	Cover Plate - 8 Module - Horizontal - Matt Silver	434	5/50
 6776 09	Cover Plate - 2*4 Module - Vertical - Matt Silver	436	5/25
 6776 10	Cover Plate - 9 Module - Matt Silver	468	5/50
 6776 12	Cover Plate - 12 Module - Matt Silver	618	10
 6776 16	Cover Plate - 16 Module - Matt Silver	714	10
 6776 67	Cover Plate - 16 Module - Matt Silver	718	1/10
 6776 18	Cover Plate - 18 Module - Matt Silver	980	10

Bold Cat.Nos are products normally available with Legrand (India) Stockists. Cat.Nos that are not bold - delivery within 4 - 8 weeks from the date of order. Bold packing quantity is our mandatory packing. Orders to be placed by Legrand (India) Stockist in multiples of the same.

Lyncus™ boxes

Lyncus™
Change to today

Cat.Nos	Description	MRP* ₹ / Unit	Pack
---------	-------------	---------------------	------

Accessories

Metal flush boxes

6890 07	Metal Flush Box - 1/2 Module	144	40
6890 08	Metal Flush Box - 3 Module	144	40
6890 09	Metal Flush Box - 4 Module	190	40
6890 10	Metal Flush Box - 6 Module	302	40
6890 42	Metal Flush Box - 8 Module	352	40
6890 31	Metal Flush Box - 2*4 Module	350	20
6890 29	Metal Flush Box - 9 Module	416	20
6890 11	Metal Flush Box - 12/16 Module	530	10
6890 13	Metal Flush Box - 16 Module	610	10
6890 12	Metal Flush Box - 18 Module	668	10

Plastic surface boxes

6733 02	Plastic Surface Box - 1/2 Module	92	10/50
6733 03	Plastic Surface Box - 3 Module	106	5/35
6733 04	Plastic Surface Box - 4 Module	124	5/25
6733 06	Plastic Surface Box - 6 Module	160	1/10
6733 08	Plastic Surface Box - 8 Module	238	1/5
6733 05	Plastic Surface Box - 2*4 Module	226	1/5
6740 99	Plastic Surface Box - 9 Module	268	1/5

Metal surface boxes

6890 21	Metal Surface Box - 12 Module (2 Rows*6)	564	1/6
6890 22	Metal Surface Box - 18 Module (3 Rows*6)	594	1/4

Guarantee

- The Company, at its discretion, will replace products if they have any manufacturing defect within 10 years for switches (without LED lamp) and power sockets. For all other **Lyncus™** wiring accessories the guarantee will be 2 years.
- The above guarantee is applicable when the devices are used in Legrand metal flush boxes. Otherwise the guarantee period will be reduced by 50%.
- The guarantee is only applicable when the products are installed as per the Company's instructions and not tampered in any manner.
- The guarantee states the Company's entire liability. It does not extend to cover consequential loss or damage or installation costs arising from defective products.

* To be Introduced Shortly
Red Cat.Nos - new products

Bold Cat.Nos are products normally available with Legrand (India) Stockists. Cat.Nos that are not bold - delivery within 4 - 8 weeks from the date of order. Bold packing quantity is our mandatory packing. Orders to be placed by Legrand (India) Stockist in multiples of the same.

Allzy™

The All-rounder Switch

The All-rounder Switch For All Of India.

A superior quality switch loaded with features from the house of Legrand.

2 COLOUR MECHANISMS

White



Matt Black



Scan to know more about
the product.

5 EXQUISITE PLATE FINISHES.



The Allzy range of switches comes in 5 attractive finishes that are a class apart. It also offers a range of mechanisms in black and white for you to choose from.

Colour Plates:

White

Alu

Champagne

Rose Gold

Gold

Matt Black



LIVE THE **ADVANTAGE** OF AN **ALL-ROUNDER.**

RANGE

SWITCHES



6A Switch 1W-
Light Marking



6A Switch 1W-
Fan Marking



20A DP Switch 1W-
Indicator Marking



6A Bell Push 1W-
Indicator Marking



Gold- Plate & Frame



Aluminium Champagne-
Plate & Frame



Rose Gold-Plate & Frame



White-Plate & Frame



Matt Black-Plate & Frame

SOCKETS

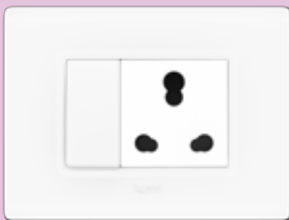

6/16A Socket with shutter
- ISI Mark

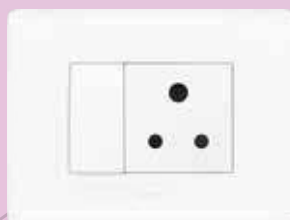

6A 3 Pin Socket with Shutter
- ISI Mark

ELECTRONICS



Fan Regulator 8 step 100W



Fan Regulator 360° 100W
(ISI mark)



Rotary Dimmer 500W

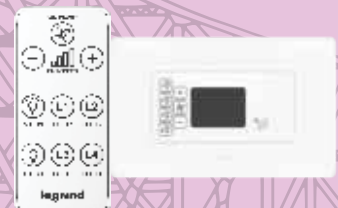

Remote Control Unit

USB



USB Charger Type A+C 3A 1M White



USB Charger Type C+C 30W PD 2M White



USB Charger 1500mA Type C



USB Charger Type C 45W PD 2M Matt Black



Double USB 3000mA Type A & Type C

VOICE & DATA COMMUNICATIONS



Double RJ11 Telephone Socket (with Shutter)



RJ11 Telephone Socket (with Shutter)



RJ45 Cat6 UTP Socket (with Shutter)

AUDIO VIDEO CONNECTOR



Preterminated Audio Video Connector



Preterminated HDMI Socket

PROTECTION



Power Unit with 20A MCB & 16A Plug



32A Modular MCB DP

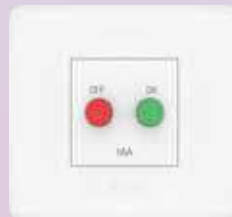

16A Motor starter

HOSPITALITY



Key card 15A switch-Card 230V



32A DP Key tag switch (Mechanical)



Shaver Socket 120/230V AC with plate



DND & MMR indicator-6A bell push (Outside)



DND & MMR (Inside)



Allzy™ white - mechanism

Cat.Nos	Description	MRP* ₹ / Unit	Pack
---------	-------------	------------------	------

Switches 6A - 230V AC

6811 00	6A - Switch - SP - 1 Way - 1 Module	48	20/200
6811 11	6A - Switch - SP - 2 Way - 1 Module	104	20/200
6811 02	6A - Switch - SP - 1 Way - with Indicator - 1 Module	90	20/200
6811 03	6A - Switch - SP - 1 Way - with "Light" Marking - 1 Module	92	20/200
6811 04	6A - Switch - SP - 1 Way - with "Fan" Marking - 1 Module	92	20/200

Switches - 10A - 230V AC

6811 74	10A - Switch - 1 Way - 1 Module	50	20/200
6811 75	10A - Switch - 2 Way - 1 Module	106	20/200
6811 76	10A - Switch - 1 Way - with Indicator - 1 Module	92	20/200

Switches - 16A - 230V AC

6811 01	16A - Switch - SP - 1 Way - 1 Module	124	20/200
6811 12	16A - Switch - SP - 2 Way - 1 Module	178	20/200
6811 05	16A - Switch - SP - 1 Way - with Indicator - 1 Module	162	20/200

Switches - 20A - 230V AC

6811 07	20A - Switch - SP - 1 Way - 1 Module	148	20/200
6811 08	20A - Switch - SP - 1 Way - with Indicator - 1 Module	194	20/200
6811 13	20A - Switch - SP - 1 Way - with Indicator - 2 Module	224	10/100
6811 15	20A - Switch - DP - 1 Way - with Indicator - 2 Module	228	10/100

Switches - 25A - 230V AC

6811 06	25A - Switch - SP - 1 Way - with Indicator - 1 Module	206	20/200
---------	---	-----	--------

Switches - 32A - 230V AC

6811 16	32A - Switch - DP - 1 Way - with Indicator - 2 Module	304	10/100
---------	---	-----	--------

Push button - 6A - 230V AC

6811 09	6A - Bell Push - SP - 1 Way - 1 Module	102	20/200
6811 10	6A - Bell Push - SP - 1 Way - with Indicator - 1 Module	124	20/200
6811 14	6A - Bell Push - SP - 1 Way - with Indicator - 2 Module	188	10/100

Accessory for switch with indicator

6811 37	LED Indicator for Switch (Red)	38	1/5/50
---------	--------------------------------	----	--------

Indian standard sockets

6811 24	6A - Socket - with Shutter - 3 Pin - ISI - 2 Module	154	20/200
6811 22	6/16A - Socket - with Shutter - ISI - 2 Module	220	10/100
6811 26	25A - Socket - with Shutter - 2 Module	242	10/100

*Compatible with Atomberg (Efficio), Havells (Efficiencia neo), Orient (Aerostorm) as per 2023 fan models.

Allzy™ white - mechanism

Cat.Nos	Description	MRP* ₹ / Unit	Pack
---------	-------------	------------------	------

Dimmers and fan regulators

6811 43	Rotary Dimmer - 400 Watts - 1 Module	460	5/50
6811 44	Rotary Dimmer - 500 Watts - 2 Module	596	10/100
6811 40	Fan Regulator - 4 Step - 100 Watts - ISI - 1 Module	452	5/50
6811 41	Fan Regulator - 100 Watts - with 360° Rotation - ISI - 2 Module	520	10/100
6811 42	Fan Regulator - 8 Step - 100 Watts - 2 Module	566	1/10/100
6811 99	Fan Regulator - BLDC - 2 Module^	530	10/100

Skirting light

6811 50	Skirting Light - 2 Module	372	10/50
---------	---------------------------	-----	-------

Indicator

6811 38	Flat Indicator Red - 1 Module	116	20/200
---------	-------------------------------	-----	--------

Bell call indicator

6811 46	Bell Call Indicator - 1 Module	644	20/200
---------	--------------------------------	-----	--------

Buzzer

6811 39	Buzzer - 230V - 1 Module	336	20/200
---------	--------------------------	-----	--------

Remote unit

6811 54	Remote Control Unit - for Light & Fan - 4 Module	6580	1/5/20
---------	--	------	--------

Hospitality function

Hotel keycard switch

6811 17	32A - DP - Key Tag Switch (Mechanical) - 2 Module	468	1/10
6811 47	15A - Key Card Switch with Key Fob - Monoblock	2268	1/10

Hotel "DND and MMR" functions

6811 48	Internal DND & MMR Control Unit - 2 Module	308	10/100
6811 49	External DND & MMR Control Unit - with Bell Push - 2 Module	346	10/100

Shaver socket

6811 55	Shaver Socket - 120V/230V - with Plate - 4 Module	4260	1/5/20
---------	---	------	--------

Sockets & Connectors

Tv sockets

6811 33	TV Co - axial Socket - 1 Module	106	20/200
---------	---------------------------------	-----	--------

Data & voice

6811 30	Telephone Socket - RJ11 - with Shutter - 1 Module	112	20/200
6811 31	Telephone Socket - Double RJ11 - with Shutter - 1 Module	168	20/200
6811 32	Information Socket - RJ45 - Cat 6 - UTP - with Shutter - 1 Module	632	20/200

Audio video connectors

6811 34	Preterminated HDMI Socket - 1 Module	1156	1/10
6811 35	Preterminated Audio/Video Connector - 1 Module	1152	1/10
6811 36	Preterminated Projector Connector - 1 Module	1501	1/10

Sound (electronic bell)

6811 45	Electronic Bell - 2 Module	280	10/100
---------	----------------------------	-----	--------

Protectors and accessories Motor starter

6811 66	16A - Motor Starter - 2 Module	528	1/10/100
6811 67	25A - Motor Starter - 2 Module	528	1/10/100

Bold Cat.Nos are products normally available with Legrand (India) Stockists. Cat.Nos that are not bold - delivery within 4 - 8 weeks from the date of order. Bold packing quantity is our mandatory packing. Orders to be placed by Legrand (India) Stockist in multiples of the same.

Allzy™ white - mechanism

Cat.Nos	Description	MRP* ₹ / Unit	Pack
---------	-------------	------------------	------

Modular MCB (IS : 608981:2002)

6811 56	6A - Modular MCB - SP - 1 Module	396	1/10/100
6811 57	10A - Modular MCB - SP - 1 Module	396	1/10/100
6811 58	16A - Modular MCB - SP - 1 Module	396	1/10/100
6811 59	20A - Modular MCB - SP - 1 Module	396	1/10/100
6811 60	25A - Modular MCB - SP - 1 Module	396	1/10/100
6811 61	32A - Modular MCB - SP - 1 Module	396	1/10/100
6811 62	16A - Modular MCB - DP - 2 Module	754	1/10/100
6811 63	20A - Modular MCB - DP - 2 Module	754	1/10/100
6811 64	25A - Modular MCB - DP - 2 Module	754	1/10/100
6811 65	32A - Modular MCB - DP - 2 Module	754	1/10/100

Power unit

6811 27	Power Unit with 20A SP MCB & 16A Plug - 3 Module	1174	1/10
6811 28	Power Unit with 25A SP MCB & 16A Plug - 3 Module	1256	1/10

Electronic function

USB chargers (IS13252 (Part 1) / IEC 60950-1)

6811 52	USB Charger - 1500mA - Type A - 1 Module	884	10/100
6811 71	USB Charger - 1500mA - Type C - 1 Module	1064	10/100
6811 51	USB Charger - 3000mA - Type A+ A - 2 Module	1412	10/100
6811 70	USB Charger - 3000mA - Type A + C - 2 Module	1714	1/10/100
6811 80	USB Charger - 3000mA/15 Watts - Type A - 1 Module	1378	1/5/50
6811 81	USB Charger - 3000mA/15 Watts - Type A + A - 1 Module	1518	1/5/50
6811 82	USB Charger - 3000mA/15 Watts - Type A + C - 1 Module	1934	1/5/50
6811 83	USB Charger - 3000mA/15 Watts - Type C + C - 1 Module	2112	1/5/50
6811 84	USB Charger - Power Delivery - 20 Watts - Type C - 1 Module	2568	1/5/50
6811 85	USB Charger - Power Delivery - 30 Watts - Type C + C - 2 Module	4872	1/3/30
6811 86	USB Charger - Power Delivery - 45 Watts - Type C - 2 Module	6400	1/3/30
6811 87	USB Charger - Power Delivery - 63 Watts - Type C + C - 3 Module	7930	1/5/20

Accessories

6811 68	Cable Outlet - 8MM - 1 Module	90	20/200
6811 69	Blanking Plate - 1 Module	28	40/400

Matt black mechanism

Switches 6A - 230 V AC

6812 00	6A - Switch - SP - 1 Way - 1 Module	52	20/200
6812 11	6A - Switch - SP - 2 Way - 1 Module	118	20/200
6812 02	6A - Switch - SP - 1 Way - with Indicator - 1 Module	100	20/200
6812 03	6A - Switch - SP - 1 Way - with "Light" Marking - 1 Module	106	20/200
6812 04	6A - Switch - SP - 1 Way - with "FAN" Marking - 1 Module	106	20/200

Allzy™ matt black - mechanism

Cat.Nos	Description	MRP* ₹ / Unit	Pack
---------	-------------	------------------	------

Switches 16A - 230 V AC

6812 01	16A - Switch - SP - 1 Way - 1 Module	142	20/200
6812 12	16A - Switch - SP - 2 Way - 1 Module	204	20/200
6812 05	16A - Switch - SP - 1 Way - with Indicator - 1 Module	186	20/200

Switches 20A - 230V AC

6812 07	20A - Switch - SP - 1 Way - 1 Module	174	20/200
6812 08	20A - Switch - SP - 1 Way - with Indicator - 1 Module	228	20/200
6812 13	20A - Switch - SP - 1 Way - with Indicator - 2 Module	256	10/100
6812 15	20A - Switch - DP - 1 Way - with Indicator - 2 Module	256	10/100

Switches 25A - 230 V AC

6812 06	25A - Switch - SP - 1 Way - with Indicator - 1 Module	234	20/200
---------	---	-----	--------

Switches 32A - 230 V AC

6812 16	32A - Switch - DP - 1 Way - with Indicator - 2 Module	348	1/100
---------	---	-----	-------

Push button 6A - 230 V AC

6812 09	6A - Bell Push - SP - 1 Way - 1 Module	116	20/200
6812 10	6A - Bell Push - SP - 1 Way - with Indicator - 1 Module	142	20/200
6812 14	6A - Bell Push - SP - 1 Way - with Indicator - 2 Module	218	10/100

Indian standard sockets

6812 24	6A - Socket - with Shutter - 3 Pin - ISI - 2 Module	184	20/200
6812 22	6/16A - Socket - with Shutter - ISI - 2 Module	248	10/100
6812 26	25A - Socket - with Shutter - 2 Module	274	10/100

Dimmers and fan regulators

6812 43	Rotary Dimmer - 400 Watts - 1 Module	524	5/50
6812 44	Rotary Dimmer - 500 Watts - 2 Module	678	10/100
6812 40	Fan Regulator - 4 Step - 100 Watts - ISI - 1 Module	522	5/50
6812 41	Fan Regulator - 100 Watts - with 360° Rotation - ISI - 2 Module	594	10/100
6812 42	Fan Regulator - 8 Step - 100 Watts - 2 Module	670	1/10/100
6812 99	Fan Regulator - BLDC - 2 Module^	604	10/100

Skirting light

6812 50	Skirting Light - 2 Module	424	5/50
---------	---------------------------	-----	------

Indicator

6812 38	Flat Indicator Red - 1 Module	130	20/200
---------	-------------------------------	-----	--------

Buzzer

6812 39	Buzzer - 230V - 1 Module	384	20/200
---------	--------------------------	-----	--------

^Compatible with Atomberg (Efficio), Havells (Efficiencia neo), Orient (Aerostorm) as per 2023 fan models.

Bold Cat.Nos are products normally available with Legrand (India) Stockists. Cat.Nos that are not bold - delivery within 4 - 8 weeks from the date of order. Bold packing quantity is our mandatory packing. Orders to be placed by Legrand (India) Stockist in multiples of the same.

Allzy™ matt black - mechanism

Cat.Nos	Description	MRP* ₹ / Unit	Pack
---------	-------------	------------------	------

Remote unit

6812 54	Remote Control Unit - for Light & Fan - 4 Module	7504	1/5/20
---------	--	------	--------

Hospitality function

Hotel keycard switch

6812 17	32A - DP - Key Tag Switch (Mechanical) - 2 Module	534	1/10
6812 47	15A - Key Card Switch with Key Fob - Monoblock	2848	1/10

Hotel "DND and MMR" functions

6812 48	Internal DND & MMR Control Unit - 2 Module	388	10/100
6812 49	External DND & MMR Control Unit - with Bell Push - 2 Module	436	10/100

Shaver socket

6812 55	Shaver Socket - 120V/230V - with Plate - 4 Module	4858	1/5/20
---------	---	------	--------

Sockets and connectors

Tv sockets

6812 33	TV Co - axial Socket - 1 Module	120	20/200
---------	---------------------------------	-----	--------

Data & voice

6812 30	Telephone Socket - RJ11 - with Shutter - 1 Module	130	20/200
6812 31	Telephone Socket - Double RJ11 - with Shutter - 1 Module	188	20/200
6812 32	Information Socket - RJ45 - Cat 6 - UTP - with Shutter - 1 Module	737	20/200

Audio video connectors

6812 34	Preterminated HDMI Socket - 1 Module	1317	1/10
6812 35	Preterminated Audio/Video Connector - 1 Module	1315	1/10
6812 36	Preterminated Projector Connector - 1 Module	1708	1/10

Protectors and accessories

Motor starter

6812 66	16A - Motor Starter - 2 Module	606	1/10/100
6812 67	25A - Motor Starter - 2 Module	606	1/10/100

Modular MCB (IS : 608981:2002)

6812 56	6A - Modular MCB - SP - 1 Module	454	1/10/100
6812 57	10A - Modular MCB - SP - 1 Module	454	1/10/100
6812 58	16A - Modular MCB - SP - 1 Module	454	1/10/100
6812 59	20A - Modular MCB - SP - 1 Module	454	1/10/100
6812 60	25A - Modular MCB - SP - 1 Module	454	1/10/100
6812 61	32A - Modular MCB - SP - 1 Module	454	1/10/100

Power unit

6812 27	Power Unit with 20A SP MCB & 16A Plug - 3 Module	1336	1/10
6812 28	Power Unit with 25A SP MCB & 16A Plug - 3 Module	1434	1/10



6812 47



6812 33



6812 30

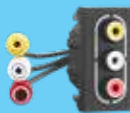

6812 35



6812 66



6812 58



6812 27

Allzy™ matt black - mechanism

Cat.Nos	Description	MRP* ₹ / Unit	Pack
---------	-------------	------------------	------

Electronic function

USB chargers (IS13252 (Part 1) / IEC 60950-1)

6812 52	USB Charger - 1500mA - Type A - 1 Module	1110	10/100
6812 71	USB Charger - 1500mA - Type C - 1 Module	1210	10/100
6812 51	USB Charger - 3000mA - Type A + A - 2 Module	1640	10/100
6812 70	USB Charger - 3000mA - Type A + C - 2 Module	1954	1/10/100
6812 80	USB Charger - 3000mA/15 Watts - Type A - 1 Module	1518	1/5/50
6812 81	USB Charger - 3000mA/15 Watts - Type A + A - 1 Module	1680	1/5/50
6812 82	USB Charger - 3000mA/15 Watts - Type A + C - 1 Module	2094	1/5/50
6812 83	USB Charger - 3000mA/15 Watts - Type C + C - 1 Module	2288	1/5/50
6812 84	USB Charger - Power Delivery - 20 Watts - Type C - 1 Module	2892	1/5/50
6812 85	USB Charger - Power Delivery - 30 Watts - Type C + C - 2 Module	5244	1/3/30
6812 86	USB Charger - Power Delivery - 45 Watts - Type C - 2 Module	6768	1/3/30
6812 87	USB Charger - Power Delivery - 63 Watts - Type C + C - 3 Module	8288	1/5/20



6812 71



6812 51



6812 80



6812 82



6812 83



6812 85

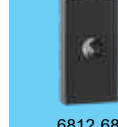

6812 86

6812 86

Accessories

6812 68	Cable Outlet - 8MM - 1 Module	102	20/200
6812 69	Blanking Plate - 1 Module	30	40/400

Cover plates with support frame

White cover plates with support frame

6813 00	Cover Plate with Frame - 1 Module - White	114	20/200
6813 01	Cover Plate with Frame - 2 Module - White	114	10/100
6813 02	Cover Plate with Frame - 3 Module - White	158	10/100
6813 03	Cover Plate with Frame - 4 Module - White	168	10/100
6813 04	Cover Plate with Frame - 6 Module - White	230	5/50
6813 05	Cover Plate with Frame - 8 Module - Horizontal-White	280	5/50
6813 06	Cover Plate with Frame - 2*4 Module - Vertical-White	280	5/25
6813 07	Cover Plate with Frame - 9 Module - White	328	5/50
6813 08	Cover Plate with Frame - 12 Module - White	406	10
6813 09	Cover Plate with Frame - 16 Module - White	434	10
6813 10	Cover Plate with Frame - 18 Module - White	462	10



6813 00



6813 04



6813 06

Bold Cat.Nos are products normally available with Legrand (India) Stockists. Cat.Nos that are not bold - delivery within 4 - 8 weeks from the date of order. Bold packing quantity is our mandatory packing. Orders to be placed by Legrand (India) Stockist in multiples of the same.

Allzy™ cover plates

Cat.Nos	Description	MRP* ₹ / Unit	Pack
---------	-------------	------------------	------

Matt black cover plates with support frame

6813 11	Cover Plate with Frame - 1 Module - Matt Black	144	20/200
6813 12	Cover Plate with Frame - 2 Module - Matt Black	144	10/100
6813 13	Cover Plate with Frame - 3 Module - Matt Black	188	10/100
6813 14	Cover Plate with Frame - 4 Module - Matt Black	214	10/100
6813 15	Cover Plate with Frame - 6 Module - Matt Black	294	5/50
6813 16	Cover Plate with Frame - 8 Module - Horizontal-Matt Black	324	5/50
6813 17	Cover Plate with Frame - 2*4 Module - Vertical-Matt Black	324	5/25
6813 18	Cover Plate with Frame - 9 Module - Matt Black	390	5/50
6813 19	Cover Plate with Frame - 12 Module - Matt Black	472	10
6813 20	Cover Plate with Frame - 16 Module - Matt Black	540	10
6813 21	Cover Plate with Frame - 18 Module - Matt Black	572	10

Gold cover plates with support frame

6813 33	Cover Plate with Frame - 1 Module - Gold	150	20/200
6813 34	Cover Plate with Frame - 2 Module - Gold	150	10/100
6813 35	Cover Plate with Frame - 3 Module - Gold	206	10/100
6813 36	Cover Plate with Frame - 4 Module - Gold	220	10/100
6813 37	Cover Plate with Frame - 6 Module - Gold	328	5/50
6813 38	Cover Plate with Frame - 8 Module - Horizontal-Gold	366	5/50
6813 39	Cover Plate with Frame - 2*4 Module - Vertical-Gold	366	5/25
6813 40	Cover Plate with Frame - 9 Module - Gold	440	5/50
6813 41	Cover Plate with Frame - 12 Module - Gold	528	10
6813 42	Cover Plate with Frame - 16 Module - Gold	572	10
6813 43	Cover Plate with Frame - 18 Module - Gold	608	10

Aluminium champagne cover plates with support frame

6813 44	Cover Plate with Frame - 1 Module - Alu Champagne	150	20/200
6813 45	Cover Plate with Frame - 2 Module - Alu Champagne	150	10/100
6813 46	Cover Plate with Frame - 3 Module - Alu Champagne	206	10/100
6813 47	Cover Plate with Frame - 4 Module - Alu Champagne	220	10/100
6813 48	Cover Plate with Frame - 6 Module - Alu Champagne	328	5/50
6813 49	Cover Plate with Frame - 8 Module - Horizontal- Alu Champagne	366	5/50
6813 50	Cover Plate with Frame - 2*4 Module - Vertical- Alu Champagne	366	5/25
6813 51	Cover Plate with Frame - 9 Module - Alu Champagne	440	5/50
6813 52	Cover Plate with Frame - 12 Module - Alu Champagne	528	10
6813 53	Cover Plate with Frame - 16 Module - Alu Champagne	572	10
6813 54	Cover Plate with Frame - 18 Module - Alu Champagne	608	10

Allzy™ cover plates

Cat.Nos	Description	MRP* ₹ / Unit	Pack
---------	-------------	------------------	------

Rose gold cover plates with support frame

6813 55	Cover Plate with Frame - 1 Module - Rose Gold	150	20/200
6813 56	Cover Plate with Frame - 2 Module - Rose Gold	150	10/100
6813 57	Cover Plate with Frame - 3 Module - Rose Gold	206	10/100
6813 58	Cover Plate with Frame - 4 Module - Rose Gold	220	10/100
6813 59	Cover Plate with Frame - 6 Module - Rose Gold	328	5/50
6813 60	Cover Plate with Frame - 8 Module - Horizontal-Rose Gold	366	5/50
6813 61	Cover Plate with Frame - 2*4 Module - Vertical-Rose Gold	366	5/25
6813 62	Cover Plate with Frame - 9 Module - Rose Gold	440	5/50
6813 63	Cover Plate with Frame - 12 Module - Rose Gold	528	10
6813 64	Cover Plate with Frame - 16 Module - Rose Gold	572	10
6813 65	Cover Plate with Frame - 18 Module - Rose Gold	608	10

Allzy™ mounting boxes accessories

Metal flush boxes

6890 60	Metal Flush Box - 1 & 2 Module	74	40
6890 61	Metal Flush Box - 3 Module	96	40
6890 62	Metal Flush Box - 4 Module	118	40
6890 63	Metal Flush Box - 6 Module	188	40
6890 65	Metal Flush Box - 8 Module	234	40
6890 64	Metal Flush Box - 8 (2 Rows*4) Module	234	20
6890 66	Metal Flush Box - 12 (2 Rows*6) Module	328	10
6890 67	Metal Flush Box - 16 (2 Rows*8) Module	370	10
6890 68	Metal Flush Box - 18 Module	420	10

Plastic surface boxes

6890 70	Plastic Surface Box - 1 & 2 Module	66	50
6890 71	Plastic Surface Box - 3 Module	82	35
6890 72	Plastic Surface Box - 4 Module	106	25
6890 73	Plastic Surface Box - 6 Module	156	10
6813 70	Plastic Surface Box - 8 Module	238	1/10
6890 74	Plastic Surface Box - 8 (2 Rows*4) Module	216	10
6890 76	Plastic Surface Box - 12 (2 Rows*6) Module	264	10
6890 77	Plastic Surface Box - 16 (2 Rows*8) Module	310	10

Bold Cat.Nos are products normally available with Legrand (India) Stockists. Cat.Nos that are not bold - delivery within 4 - 8 weeks from the date of order. Bold packing quantity is our mandatory packing. Orders to be placed by Legrand (India) Stockist in multiples of the same.

Britzy™ SWITCHES

THE
NO PROBLEM
SWITCH



ORANGE
CHROME



HERB
BEIGE



URBAN
BRONZE

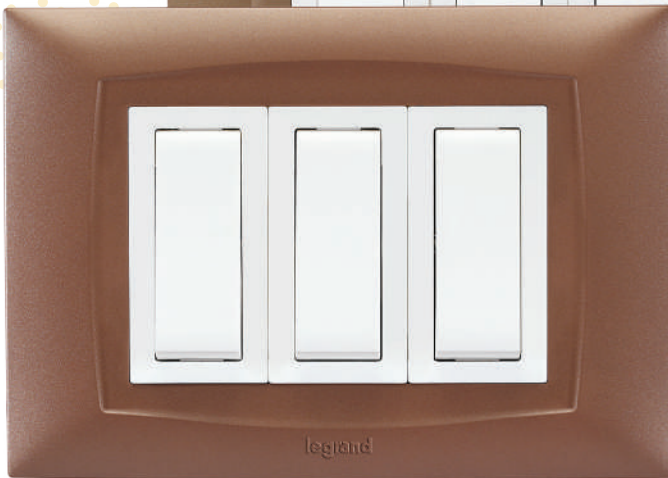

WARM
ORANGE
SILVER



Scan to know more about
the product.

Britzy™ SWITCHES

RANGE



Switch 6 A, 16 A



Switch 6 A two-way



Switch with indicator
6 A, 16 A, 25 A



Bell push with
indicator - 1 module

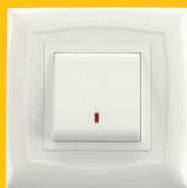

DP Switch 20 A, 32 A



Bell push with
indicator - 2 module



DND internal unit



DND external unit



6/16 A socket



Dimmer



Fan regulator
1 module



Fan regulator
2 module



USB charger
1 module



RJ 45



RJ 11 Telephone socket



Double RJ 11
Telephone socket



Bell call indicator



TV socket



Skirting light



Buzzer



Key card Switch 15 A



Flat indicator red

Britzy™ white - mechanism

Cat.Nos	Description	MRP* ₹ / Unit	Pack
---------	-------------	------------------	------

Switches – 6A - 230V AC

6734 01	6A - Switch - SP - 1 Way - 1 Module	48	20/400
6734 02	6A - Switch - SP - 2 Way - 1 Module	110	20/200
6734 03	6A - Switch - SP - 1 Way - with Indicator - 1 Module	110	20/200



6734 01

Switches – 16A - 230V AC

6734 11	16A - Switch - SP - 1 Way - 1 Module	156	20/200
6734 12	16A - Switch - SP - 2 Way - 1 Module	188	20/200
6734 13	16A - Switch - SP - 1 Way - with Indicator - 1 Module	170	20/200



6734 12

Switches – 20A - 230V AC

6734 25	20A - Switch - DP - 1 Way - with Indicator - 2 Module	240	10/100
---------	---	-----	--------



6734 25

Switches – 25A - 230V AC

6734 24	25A - Switch - SP - 1 Way - with Indicator - 1 Module	214	20/200
---------	---	-----	--------

Switches – 32A - 230V AC

6734 26	32A - Switch - DP - 1 Way - with Indicator - 2 Module	316	10/100
---------	---	-----	--------

Push buttons

6734 04	6A - Bell Push - with Indicator - 1 Module	130	20/200
6734 06	6A - Bell Push - with Indicator - 2 Module	196	10/100



6734 04

Indian standard sockets

6734 27	6A - Socket - with Shutter - 3 Pin - ISI - 2 Module	126	20/200
6734 55	6/16A - Socket - with Shutter - 3 Pin - ISI - 2 Module	220	10/100
6734 56	25A - Socket - with Shutter - 3 Pin - 2 Module	244	10/100



6734 55



6734 56

Data & voice

6734 41	Telephone Socket - RJ11 - 1 Module	112	20/200
6734 44	Telephone Socket - Double RJ11 - 1 Module	168	20/200
6734 45	Information Socket - RJ45 - Cat 6 - 1 Module	296	20/200



6734 44



6734 45

Television socket

6734 46	TV Co - axial Socket - 1 Module	106	20/200
---------	---------------------------------	-----	--------



6734 46

Buzzer

6734 40	Buzzer - 230V - 1 Module	358	20/200
---------	--------------------------	-----	--------

* MRP - Maximum Retail Price Inclusive of all taxes including GST.
* To be Introduced Shortly

Britzy™ white - mechanism

Cat.Nos	Description	MRP* ₹ / Unit	Pack
---------	-------------	------------------	------

Dimmers and fan regulators

6734 31	Fan Regulator - 100 Watts - ISI - 1 Module	476	5/50
6734 30	Fan Regulator - 100 Watts - ISI - 2 Module	606	10/100
6734 33	Light Dimmer - 400 Watts - 1 Module	488	5/50
6734 38	Fan Regulator - 8 Step - 100 Watts - 2 Module	546	10/100



6734 31

Bell call indicator

6734 07	Bell Call Indicator - 1 Module	664	20/200
---------	--------------------------------	-----	--------



6734 07

Motor starter

6734 66	25A - Motor Starter - 2 Module	560	10/100
---------	--------------------------------	-----	--------



6734 66

Modular MCB (IS : 60898-1:2002)

6734 64	16A - Modular MCB - SP - 1 Module	384	1/10/100
6734 61	20A - Modular MCB - SP - 1 Module	384	1/10/100
6734 36	25A - Modular MCB - SP - 1 Module	384	1/10/100
6734 37	32A - Modular MCB - SP - 1 Module	384	1/10/100

USB charger

6731 35	USB Charger - 1500mA - Type A - 1 Module	986	10/100
---------	--	-----	--------



6731 35

Skirting light

6734 77	Skirting Light - 2 Module	474	5/50
---------	---------------------------	-----	------



6734 77

Indicator

6734 75	Flat Indicator Red - 1 Module	118	20/200
---------	-------------------------------	-----	--------



6734 75

Hospitality function Hotel keycard switch

6734 80	15A - Key Card Switch - 2 Module	2378	1/10
6734 83	Key Fob for Key Card Switch	174	1/10/100



6734 80

Hotel "DND and MMR" functions

6734 81	Internal DND & MMR Control Unit	266	10/100
6734 82	External DND & MMR Control Unit - with Bell Push - 2 Module	314	10/100



6734 82

Accessories















6734 71	Cable Outlet - 1 Module	92	20/200
6734 90	Blanking Plate - 1 Module	30	20/200
6734 72	Blanking Plate - 2 Module	42	10/100

Bold Cat.Nos are products normally available with Legrand (India) Stockists. Cat.Nos that are not bold - delivery within 4 - 8 weeks from the date of order. Bold packing quantity is our mandatory packing. Orders to be placed by Legrand (India) Stockist in multiples of the same.

Britzy™ plates with frame

Cat.Nos	Description	MRP* ₹ / Unit	Pack
Cover plates with support frame			
White cover plates with support frame			
 6734 91	Cover Plate - 1 Module - White	92	20/200
 6734 92	Cover Plate - 2 Module - White	92	20/200
 6734 93	Cover Plate - 3 Module - White	128	10/100
 6734 94	Cover Plate - 4 Module - White	136	10/100
 6734 96	Cover Plate - 6 Module - White	180	5/50
 6734 98	Cover Plate - 8 Module - Horizontal - White	230	5/50
 6734 95	Cover Plate - 2*4 Module - Vertical - White	230	5/25
 6734 97	Cover Plate - 12 Module - White	334	10
 6734 99	Cover Plate - 16 Module - White	358	10
 6735 00	Cover Plate - 18 Module - White	442	10
Warm orange silver cover plates with support frame			
 6735 01	Cover Plate - 1 Module - Warm Orange Silver	152	20/200
 6735 02	Cover Plate - 2 Module - Warm Orange Silver	152	20/200
 6735 03	Cover Plate - 3 Module - Warm Orange Silver	192	10/100
 6735 04	Cover Plate - 4 Module - Warm Orange Silver	230	10/100
 6735 05	Cover Plate - 6 Module - Warm Orange Silver	320	5/50
6735 06	Cover Plate - 8 Module - Horizontal - Warm Orange Silver	342	5/50
6735 07	Cover Plate - 2*4 Module - Vertical - Warm Orange Silver	414	5/25
6735 08	Cover Plate - 12 Module - Warm Orange Silver	576	10
6735 09	Cover Plate - 16 Module - Warm Orange Silver	778	10
6735 10	Cover Plate - 18 Module - Warm Orange Silver	894	10

Britzy™ plates with frame

Cat.Nos	Description	MRP* ₹ / Unit	Pack
Herb beige cover plates with support frame			
 6735 11	Cover Plate - 1 Module - Herb Beige	152	20/200
 6735 12	Cover Plate - 2 Module - Herb Beige	152	20/200
 6735 13	Cover Plate - 3 Module - Herb Beige	192	10/100
 6735 14	Cover Plate - 4 Module - Herb Beige	230	10/100
 6735 15	Cover Plate - 6 Module - Herb Beige	320	5/50
 6735 16	Cover Plate - 8 Module - Horizontal - Herb Beige	342	5/50
 6735 17	Cover Plate - 2*4 Module - Vertical - Herb Beige	414	5/25
 6735 18	Cover Plate - 12 Module - Herb Beige	576	10
 6735 19	Cover Plate - 16 Module - Herb Beige	778	10
 6735 20	Cover Plate - 18 Module - Herb Beige	894	10
Urban bronze cover plates with support frame			
 6735 21	Cover Plate - 1 Module - Urban Bronze	152	20/200
 6735 22	Cover Plate - 2 Module - Urban Bronze	152	20/200
 6735 23	Cover Plate - 3 Module - Urban Bronze	192	10/100
 6735 24	Cover Plate - 4 Module - Urban Bronze	230	10/100
 6735 25	Cover Plate - 6 Module - Urban Bronze	320	5/50
6735 26	Cover Plate - 8 Module - Horizontal - Urban Bronze	342	5/50
6735 27	Cover Plate - 2*4 Module - Vertical - Urban Bronze	414	5/25
6735 28	Cover Plate - 12 Module - Urban Bronze	576	10
6735 29	Cover Plate - 16 Module - Urban Bronze	778	10
6735 30	Cover Plate - 18 Module - Urban Bronze	894	10









* MRP - Maximum Retail Price Inclusive of all taxes including GST.
 * To be Introduced Shortly

Bold Cat.Nos are products normally available with Legrand (India) Stockists.
 Cat.Nos that are not bold - delivery within 4 - 8 weeks from the date of order.
 Bold packing quantity is our mandatory packing. Orders to be placed by Legrand (India) Stockist in multiples of the same.









Britzy™ mounting boxes

Cat.Nos	Description	MRP* ₹ / Unit	Pack
---------	-------------	---------------------	------

Orange chrome cover plates with support frame

 6735 31	Cover Plate - 1 Module - Orange Chrome	152	20/200
 6735 33	Cover Plate - 2 Module - Orange Chrome	152	20/200
 6735 35	Cover Plate - 3 Module - Orange Chrome	192	10/100
 6735 35	Cover Plate - 4 Module - Orange Chrome	230	10/100
 6735 35	Cover Plate - 6 Module - Orange Chrome	320	5/50
 6735 37	Cover Plate - 8 Module - Horizontal - Orange Chrome	342	5/50
 6735 37	Cover Plate - 2*4 Module - Vertical - Orange Chrome	414	5/25
 6735 38	Cover Plate - 12 Module - Orange Chrome	576	10
 6735 39	Cover Plate - 16 Module - Orange Chrome	778	10
 6735 40	Cover Plate - 18 Module - Orange Chrome	894	10

Accessories Metal flush boxes

 6890 60	Metal Flush Box - 1 & 2 Module	74	40
 6890 61	Metal Flush Box - 3 Module	96	40
 6890 62	Metal Flush Box - 4 Module	118	40
 6890 63	Metal Flush Box - 6 Module	188	40
 6890 65	Metal Flush Box - 8 Module	234	40
 6890 64	Metal Flush Box - 8 (2 Rows*4) Module	234	20
 6890 66	Metal Flush Box - 12 (2 Rows*6) Module	328	10
 6890 67	Metal Flush Box - 16 (2 Rows*8) Module	370	10
 6890 68	Metal Flush Box - 18 Module	420	10

* MRP - Maximum Retail Price Inclusive of all taxes including GST.
* To be Introduced Shortly

Britzy™ mounting boxes

Cat.Nos	Description	MRP* ₹ / Unit	Pack
---------	-------------	---------------------	------

Plastic surface boxes

6890 70	Plastic Surface Box - 1 & 2 Module	66	50
6890 71	Plastic Surface Box - 3 Module	82	35
6890 72	Plastic Surface Box - 4 Module	106	25
6890 73	Plastic Surface Box - 6 Module	156	10
6890 75	Plastic Surface Box - 8 Module	216	10
6890 74	Plastic Surface Box - 8 (2 Rows*4) Module	216	10
6890 76	Plastic Surface Box - 12 (2 Rows*6) Module	264	10
6890 77	Plastic Surface Box - 16 (2 Rows*8) Module	310	10

Metal Surface Box

6890 78	Metal Surface Box - 18 Module	328	10
---------	-------------------------------	-----	----

Bold Cat.Nos are products normally available with Legrand (India) Stockists. Cat.Nos that are not bold - delivery within 4 - 8 weeks from the date of order. Bold packing quantity is our mandatory packing. Orders to be placed by Legrand (India) Stockist in multiples of the same.

Britzy™ SWITCHES

THE NO PROBLEM SWITCH



Guarantee

- The Company, at its discretion, will replace products if they have any manufacturing defect within 10 years for switches (without LED lamp) and power sockets. For all other Britzy™ wiring accessories the guarantee will be 2 years.
- The above guarantee is applicable when the devices are used in Legrand metal flush boxes. Otherwise the guarantee period will be reduced by 50%.
- The guarantee is only applicable when the products are installed as per the Company's instructions and not tampered in any manner.
- The guarantee states the Company's entire liability. It does not extend to cover consequential loss or damage or installation costs arising from defective products.

UX FOR UPSCALE HOTELS

FIVE STAR SOLUTION

Designed specifically for premium level establishments, UX for Upscale Hotels provides top quality solutions with its brand-new touchplates and enhanced functionalities. Operating on an open protocol, the guest room management system can seamlessly integrate with third party building management systems, thus raising hospitality to new heights across the world. In conjunction with Arteor or other Legrand wiring device ranges.



EXTERNAL READER



Scan to know more about
the product.

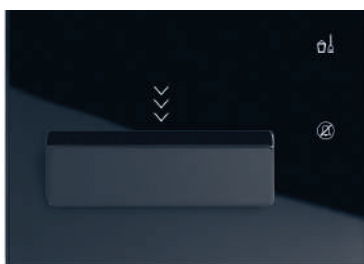

KEY CARD READER

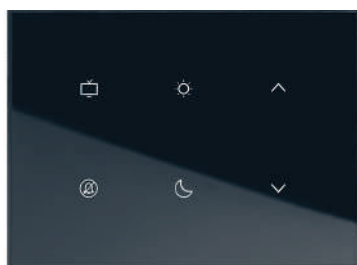

6-GANG TOUCH PLATE

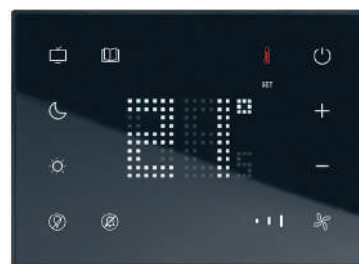

BEDSIDE PANEL

BUS/KNX SOLUTIONS

ACTIVE CONTROL OF LIGHTING, SHUTTERS, TEMPERATURE AND SOCKET OUTLETS



NEW NEW MALLIA SENSES
MULTIFUNCTION KEYPADS,
ROOM CONTROLLERS &
DISPLAY UNITS

Transform your building's capabilities with Legrand's BUS/KNX solutions. Tailor your lighting to every scenario with our advanced KNX system, ensuring comfort and efficiency. Explore the new aesthetics for more exciting possibilities



Touch Screen

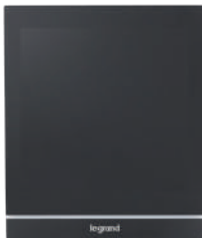

Touch Screen

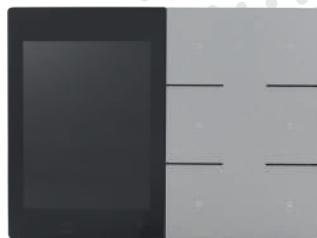

Room Controller Units



Room Controller Units

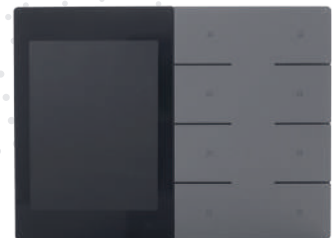

Room Controller Units



LIVING NOW KNX Keypads: Smart Control at your Fingertips

Available in 4 and 6 channel controls, our KNX keypads are available in 3 mechanism colors and 16 plate finishes. Manage lighting, shutters, sockets, and HVAC effortlessly.



WHITE



SAND



BLACK

LIVING NOW IoT

REDEFINING SMART LIVING

State-of-the-art electric & digital infrastructures for the modern home.



Touch control



Control with
smartphone



Voice control

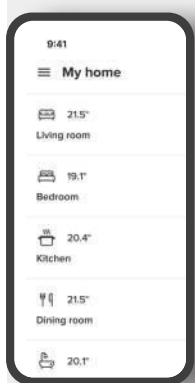

- **Innovative design:** revisited relationship between cover plate and functions.
- **Smart:** the first intrinsically connected wiring devices range!
- The best technical solutions for a **perfect installation.**



NEW WIRELESS 4 SCENARIOS CONTROL

Works with



Control with

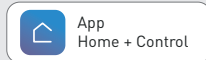

Scan to know more about
the product.

REDEFINING SMART LIVING



MIX OF INNOVATION AND SIMPLICITY, READY TO BE DISCOVERED.



TOUCH CONTROL



CONTROL WITH
SMARTPHONE



VOICE CONTROL



Living Now, has won this prestigious international award confirming Legrand's ability to combine technology and design.



WORKSTATION SOLUTIONS

POWER AND DATA DISTRIBUTION FOR THE OFFICE ENVIRONMENT

In order to guarantee convenience and performance for users in office buildings, workstations & different areas must be fitted with solutions that can be fully adjusted to different building infrastructures and still meet the user's connectivity and mobility needs.

These ranges of products are solutions for supplying and fitting out workstations in any kind of building infrastructure: Raised Floor, Flush Floor, Screed Floor & False Ceiling & Wall.



Pop-up boxes - for floor



Snap-On mini-columns

LEGRAND'S SOLUTION FOR DISTRIBUTING POWER AND DATA TO WORKSTATIONS

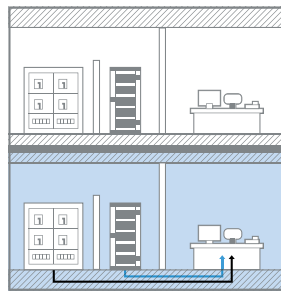

Work station solution supplied through the floor

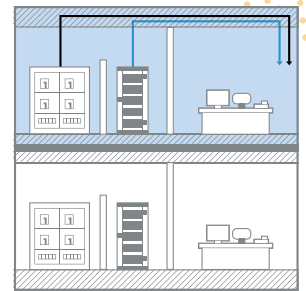

Work station solution supplied through the false ceiling & the wall



Scan to know more about the product.

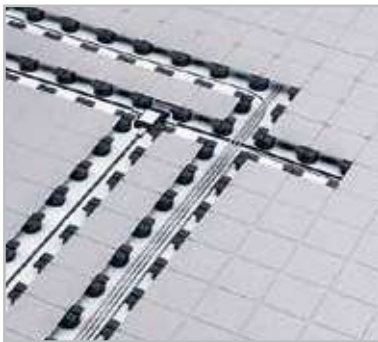

Soluflex cable floor system

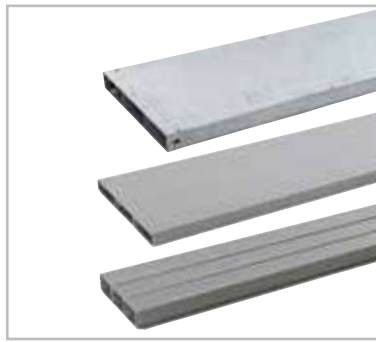

Raceways : PVC & Metal (GI)



Floor boxes



Pop- up Box



Dlp trunking system:
Snap-on, Mini & PVC, Aluminium

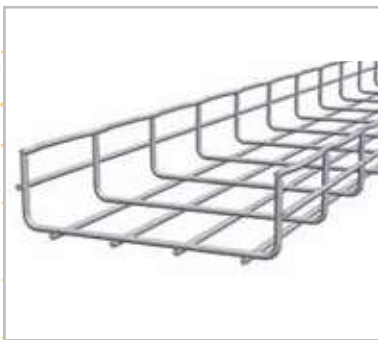

Cablófil wire mesh cable trays



Cable worm

POWER AND DATA DISTRIBUTION & CONNECTION SOLUTIONS

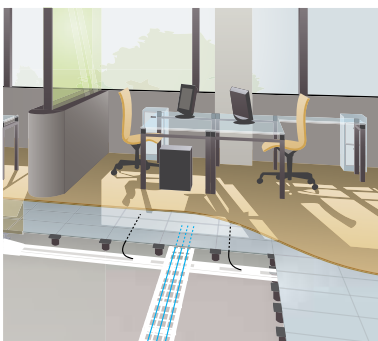

Raised access floor systems



Screed floor system

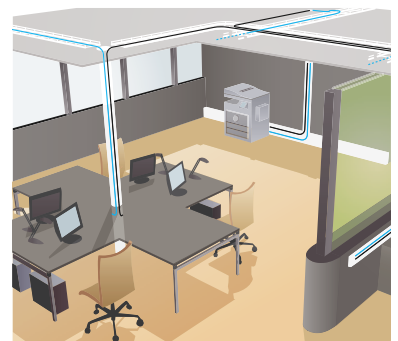

Wall and ceiling systems

CABLOFIL®

CABLOFIL IS THE MOST VERSATILE CABLE TRAY

Since its introduction 40 years ago, CABLOFIL has revolutionized Electrical and Telecommunication Cable support systems. CABLOFIL is one of the safest and most economical cable support systems available.

Made from welded steel wires, CABLOFIL meets the strictest of safety standards and satisfies the customer's need for reliability and fast economical installation.

Cablofil is a Full cable Management Solution

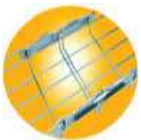

FAST -
Fast Coupling Solution Without Nuts And Bolts
Time Saving For More Economy



EASY-
Fixing Without Hardware On Profiles And Brackets
Secure By Bending The Fastening Tab
No More Nuts And Bolts



SECURE
For Cables
For Installers
For Installations
Natural Ventilation Of Cables
Cleanliness With No Retention Of Dust



AVAILABLE
2000 Items In Stock
8 Regional Hubs Worldwide
More Than 2000 Distributors
And our service with the same Quantity For Products Are Available In More Than 60 Countries Around The World

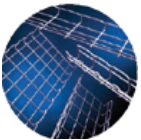

COMPLETE RANGE
For Every Environments
For Any Type Of Installations
For Any Type Of Activities



QUALITY
The most tested and Certified Cable Tray
The Most Specified Cable Tray In The World
40 Years Of Sales & Technical Assistance



ECONOMICAL
Cable Management Made On-Site
Time Saving, Forget About Specifics Development!
No More Specific Products For Derivations
No More Missing Products On-Site



PERFORMANCE
Maximum Strength
Gauranteed Span Of 2 Meters Between Supports
In Conformity With European And International Standards Cei/61537 & Vde/639



Scan to know more about the product.

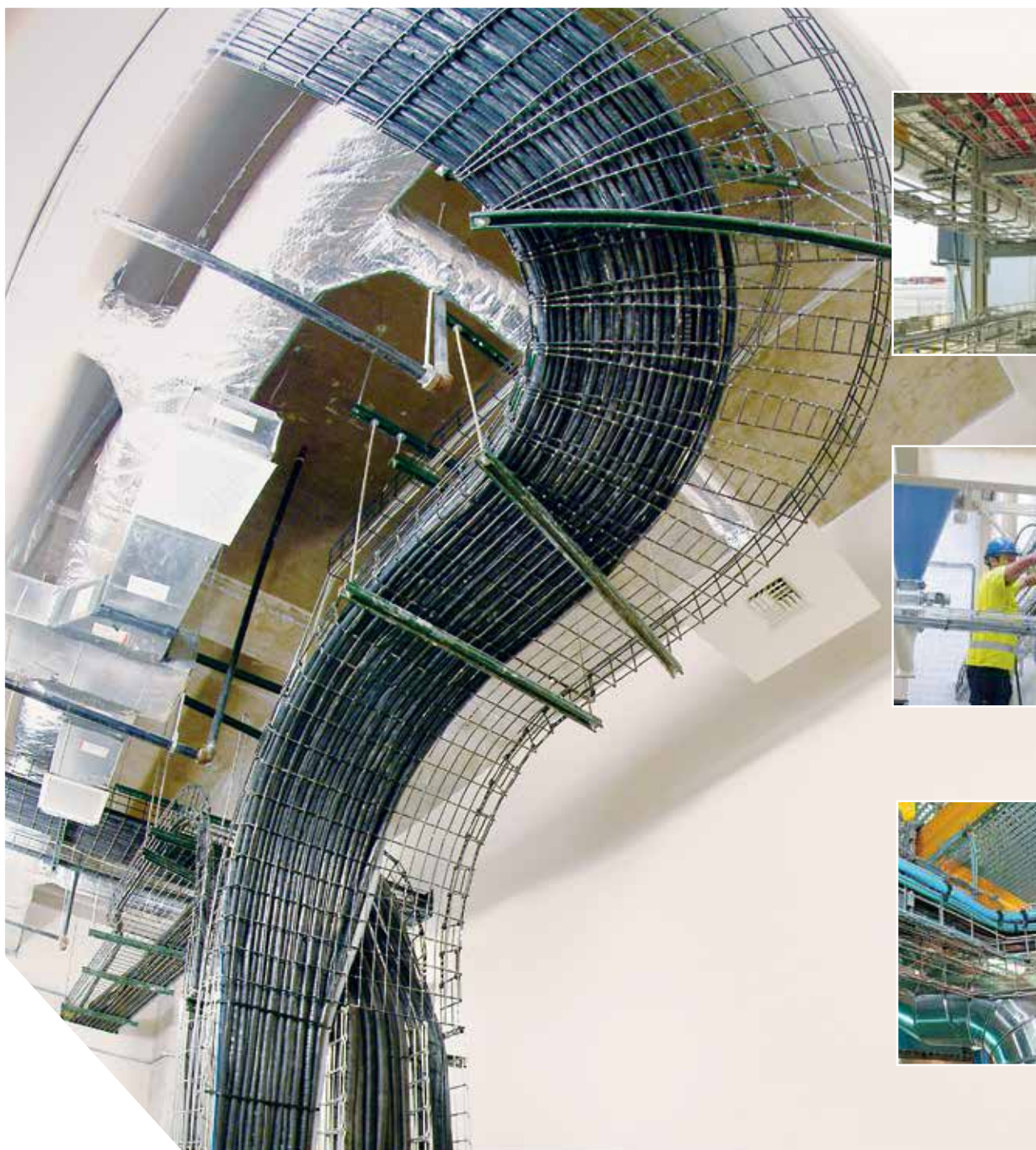

raceways and junction boxes for screed floors

Cat.Nos	Description	MRP* ₹ / Unit	Pack
---------	-------------	------------------	------

Confirms to EN 50 085 - 2 - 2
Raceways are made from PVC and Galvanised sheet.
Compatible with Cat.6 structured cabling system.

Raceways - PVC

**Raceways - PVC - height 38 mm;
Standard length 2 meters⁽¹⁾; Price per meter**

0896 67	PVC Raceway 50x38mm 1cmpt	1374	12
0896 68	PVC Raceway 100x38mm 2cmpt	2522	16
0896 69	PVC Raceway 150x38mm 3cmpt	3872	10

Raceways - metal / GI

**Raceways - Metal/GI - height 25 mm; length 2.44 m.
Price per unit (One unit is of 2.44 meters)**

6895 10	Trunking 50mmx25mm (GI)	2402	3/54 ⁽¹⁾
6895 11	Trunking 75mmx25mm (GI)	3096	3/21 ⁽¹⁾
6895 12	Trunking 100mmx25mm (GI)	3758	3/54 ⁽¹⁾
6895 13	Trunking 150mmx25mm (GI)	5078	3/18 ⁽¹⁾
6895 14	Trunking 225mmx25mm(GI)3cmpt	7964	3/12 ⁽¹⁾
6895 15	Trunking 300mmx25mm(GI)3cmpt	10096	3/18 ⁽¹⁾

**Raceways - Metal/GI - height 38 mm; length 2.44 m
Price per unit (One unit is of 2.44 meters)**

6895 00	Trunking 50mmx38mm(GI)	2790	3/54 ⁽¹⁾
6895 01	Trunking 75mmx38mm(GI)	3596	3/21 ⁽¹⁾
6895 02	Trunking 100mmx38mm(GI)	4458	3/54 ⁽¹⁾
6895 03	Trunking 150mmx38mm(GI)	5980	3/36 ⁽¹⁾
6895 04	Trunking 225mmx38mm(GI)3cmpt	8840	3/12 ⁽¹⁾
6895 05	Trunking 300mmx38mm(GI)3cmpt	11086	3/18 ⁽¹⁾

Raceways accessories

Fixing bracket (GI)

For fixing raceways (PVC & Metal) on the floor

6897 09	Fixing Brackets 50x25mm	38	9
6897 10	Fixing Brackets 75x25mm	62	9
6897 12	Fixing Brackets 100x25mm	70	9
6897 15	Fixing Brackets 150x25mm	90	9
6897 20	Fixing Brackets 225x25mm	126	9
6897 30	Fixing Brackets 300x25mm	168	9

* MRP - Maximum Retail Price Inclusive of all taxes including GST.
(1) Unit of measure in Nos
⁽¹⁾To be ordered in multiples of 2 meters

raceways and junction boxes for screed floors

Cat.Nos	Description	MRP* ₹ / Unit	Pack
---------	-------------	------------------	------

Fixing bracket

6897 27	Fixing Brackets 50x38mm	42	9
6897 28	Fixing Brackets 75x38mm	72	9
6897 37	Fixing Brackets 100x38mm	84	9
6897 38	Fixing Brackets 150x38mm	106	9
6897 25	Fixing Brackets 225x38mm	164	9
6897 35	Fixing Brackets 300x38mm	204	9

Riser

6897 23	Vertical riser for 225mm	2830	1
6897 33	Vertical riser for 300mm	3254	1

Coupler for joining raceways

6897 77	Coupling 38	168	6
6897 79	Coupling 25	126	6

Junction box

For direct access to cables at the intersection of raceways
Supplied completely with base and cover plate (Lid)

Height adjustable junction box 65 - 90 mm

6896 10	ADJ JB150 X 150 X 65-90 MM	3214	1
6896 11	ADJ JB 225 X 225 X 65-90 MM	3986	1
6896 12	ADJ JB 300 X 300 X 65-90 MM	5122	1
6896 13	ADJ JB 400 X 400 X 65-90 MM	7942	1

Height adjustable junction box 65 - 90 mm with fly over

For direct access to cables at the intersection of floor raceways
while maintaining perfect separation and 900 cross overs
between data and power cables

6896 14	ADJ JB FLYOVER 225X225X65-90MM	4296	1
6896 15	ADJ JB FLYOVER 300X300X65-90MM	5858	1
6896 16	ADJ JB FLYOVER 400X400X65-90MM	8584	1

Bold Cat.Nos are products normally available with Legrand (India) Stockists.
Cat.Nos that are not bold - delivery within 4 - 8 weeks from the date of order.
Bold packing quantity is our mandatory packing. Orders to be placed by
Legrand (India) Stockist in multiples of the same.

floor boxes for carpet for raised floor, screed floor

Cat.Nos	Description	MRP* ₹ / Unit	Pack
---------	-------------	------------------	------

Optional site cover for junction box

6896 18	METAL COVER- JB150X150X65-90MM	356	10
6896 19	METAL COVER- JB225X225X65-90MM	502	10
6896 20	METAL COVER- JB300X300X65-90MM	778	10
6896 21	METAL COVER- JB400X400X65-90MM	1158	10

Height adjustable junction box 50 - 70 mm

6896 22	ADJ JB150 X 150 X 50 MM	2958	1
6896 23	ADJ JB 225 X 225 X 50 MM	3634	1
6896 24	ADJ JB 300 X 300 X 50 MM	4724	1
6896 25	ADJ JB 400 X 400 X 50 MM	7252	1

Floor boxes for raised floor

6896 38	FULL BACKBOX (FOR CARPET BOX,	5076	1
6896 31	265X265 LID&TRIM (FLXBLE EXIT)	3756	5

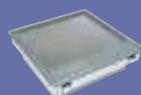

6896 38 +
6896 31

Support plates for floor boxes 77 mm width plate

6896 62	Blank plates for floor box	422	12
6896 17	Support pl-myrius/arteor 8m	430	1
6896 78	Waved Support Plates	1272	4

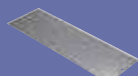

6896 62

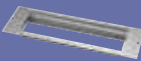

6896 17



6896 78

Floor boxes for screed floor (3 Compartment)

6896 34*	Backbox (for carpet box,	7710	1
6896 31*	265x265 lid&trim (flxble exit)	3756	5



6896 34 +
6896 31

* MRP - Maximum Retail Price Inclusive of all taxes including GST.
6896 34 + 6896 31 with support plates and wiring devices

floor boxes for tile / marble

Cat.Nos	Description	MRP* ₹ / Unit	Pack
---------	-------------	------------------	------

Support plates for floor boxes 77 mm width plate

6896 62	Blank plates for floor box	422	12
6896 17	Support pl-myrius/arteor 8m	430	1
6896 78	Waved Support Plates	1272	4

Floor boxes for screed floor (4 Compartment)

6896 45	BACKBOX for 4 Compartment	8708	1
6896 41	LID and TRIM 4 Compartment	4188	5

Support plates for floor boxes

77 mm width plate

6896 62	Blank plates for floor box	422	12
6896 17	Support pl-myrius/arteor 8m	430	1
6896 78	Waved Support Plates	1272	4

Stainless steel insert for Lid

For a metal finish on lid

To be used instead of fitting carpet onto the Lid

6896 92	SS insert for lid	4710	1
---------	-------------------	------	---

floor boxes for tile / marble

For screed floor

0896 04	Specific backbox(for tiles box)	6538	1
6896 52	Floor box tile 15to22mm thick	32818	1
6896 55	Lid/trim grey painted headband	8998	1

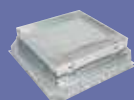

0896 04 +
6896 56

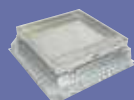

0896 04 +
6896 52

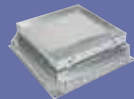

0896 04 +
6896 55

Support plates for floor boxes

77 mm width plate

6896 62	Blank plates for floor box	422	12
6896 17	Support pl-myrius/arteor 8m	430	1
6896 78	Waved support plates	1272	4

Bold Cat.Nos are products normally available with Legrand (India) Stockists.
Cat.Nos that are not bold - delivery within 4 - 8 weeks from the date of order.
Bold packing quantity is our mandatory packing. Orders to be placed by
Legrand (India) Stockist in multiples of the same.

floor boxes

Cat.Nos	Description	MRP* ₹ / Unit	Pack
50 mm reduced height floor boxes			
0880 73	Back box to be use with 088070	9650	1
0880 70	Lid and trim fir btw.50to70 mm	9530	1
0880 72	Ss finishng pl for 50mm firbox	6078	1

universal floor box

Lids and trims for floor box

0880 00	Lid+trim grey std box 8/12m	2374	1
0880 01	Lid+trim grey std box 12/18m	3172	1
0880 02	Lid+trim grey std box 16/24m	3968	1
0880 03	Lid+trim ss std box 8/12m	26992	1
0880 04	Lid+trim ss std box 12/18m	28540	1
0880 05	Lid+trim ss std box 16/24m	30380	1

Support kits for floor boxes

To be equipped with Arteur sockets

Equipped with support frames for wiring accessories

For sockets in horizontal position - adjustable height

For concrete floors, use auto-adjusting backboxes Cat.Nos 0 880 90/91/92 or universal adjustable backbox Cat.No 0 880 80 and adaptors Cat.Nos 0 880 81/82/83

0880 20	Support kit horizon 3x4m std	3986	1
0880 21	Support kit horizon 3x6m std	5044	1
0880 22	Support kit horizon 3x8m std	6602	1
0880 23	Support kit vertical 2x4m std	3172	1
0880 24	Support kit vertical 2x6m std	2644	1
0880 25	Support kit vertical 2x8m std	2644	1

floor boxes

Cat.Nos	Description	MRP* ₹ / Unit	Pack
---------	-------------	------------------	------

Universal adjustable back box

0880 80	Universal back box 55-125	15934	1
---------	---------------------------	-------	---

Mounting adaptors for concrete floor

0880 81	Adaptation plt for 8/12m	3446	1
0880 82	Adaptation plate for 12/18m	3726	1
0880 83	Adaptation plate for 16/24m	3986	1

Auto-adjusting back box

Screed height: 65 to 90 mm

For floor boxes (standard or flush version)

0880 90	Auto-ajustable back box 8/12m	5020	1
0880 91	Auto-ajustable back box 12/18m	6084	1
0880 92	Auto-ajustable back box 16/24m	7138	1

Finishing plates

For plastic lids and trims - stainless steel finish

0880 15	Ss plate std grey lid 8/12m	4682	1
0880 16	Ss plate std grey lid 12/18m	4796	1
0880 17	Ss plate std grey lid 16/24m	6508	1







For metal lids and trims - stainless steel finish

0880 45	Ss plate std ss lid 8/12m	6966	1
0880 46	Ss plate std ss lid 12/18m	7992	1
0880 47	Ss plate std ss lid 16/24m	9082	1

Bold Cat.Nos are products normally available with Legrand (India) Stockists. Cat.Nos that are not bold - delivery within 4 - 8 weeks from the date of order. **Bold packing quantity** is our mandatory packing. Orders to be placed by Legrand (India) Stockist in multiples of the same.

Standard version floor boxes for concrete floor

selection chart

SOCKET MOUNTING POSITION	CAPACITY	FLOOR BOX SUPPORT KITS	BACKBOXES		LIDS & TRIMS FLOORING THICKNESS ≤ 8 MM		FINISHING PLATES (OPTIONAL)	
			AUTO-ADJUSTING BACKBOX FOR SCREED HEIGHT UP TO 90 MM	UNIVERSAL ADJUSTABLE BACKBOX FOR SCREED HEIGHT UP TO 125 MM				
			 0 880 91	 0 880 80	 0 880 02	 0 880 05	 0 880 47	
Adjustable horizontal  H min: 80 mm	12 (3 x 4) modules	0 880 20	0 880 90 ⁽¹⁾ screed height ≥ 80 mm	0 880 80 + 0 880 81 screed height ≥ 100 mm	Plastic	0 880 00	ST steel ⁽²⁾	0 880 15
					Metal	ST steel ⁽²⁾	0 880 03	ST steel ⁽²⁾
	18 (3 x 6) modules	0 880 21	0 880 91 ⁽¹⁾ screed height ≥ 80 mm	0 880 80 + 0 880 82 screed height ≥ 100 mm	Plastic	0 880 01	ST steel ⁽²⁾	0 880 16
					Metal	ST steel ⁽²⁾	0 880 04	ST steel ⁽²⁾
	24 (3 x 8) modules	0 880 22	0 880 92 ⁽¹⁾ screed height ≥ 80 mm	0 880 80 + 0 880 83 screed height ≥ 100 mm	Plastic	0 880 02	ST steel ⁽²⁾	0 880 17
					Metal	ST steel ⁽²⁾	0 880 05	ST steel ⁽²⁾
Vertical  H min: 68 mm	8 (2 x 4) modules	0 880 23	0 880 90	0 880 80 + 0 880 81	Plastic	0 880 00	ST steel ⁽²⁾	0 880 15
					Metal	ST steel ⁽²⁾	0 880 03	ST steel ⁽²⁾
	12 (2 x 6) modules	0 880 24	0 880 91	OR 0 880 80 + 0 880 82	Plastic	0 880 01	ST steel ⁽²⁾	0 880 16
					Metal	ST steel ⁽²⁾	0 880 04	ST steel ⁽²⁾
	16 (2 x 8) modules	0 880 25	0 880 92	OR 0 880 80 + 0 880 83	Plastic	0 880 02	ST steel ⁽²⁾	0 880 17
					Metal	ST steel ⁽²⁾	0 880 05	ST steel ⁽²⁾

1: Not possible to use straight plugs - 2: Stainless Steel finish

MOUNTING PRINCIPLE

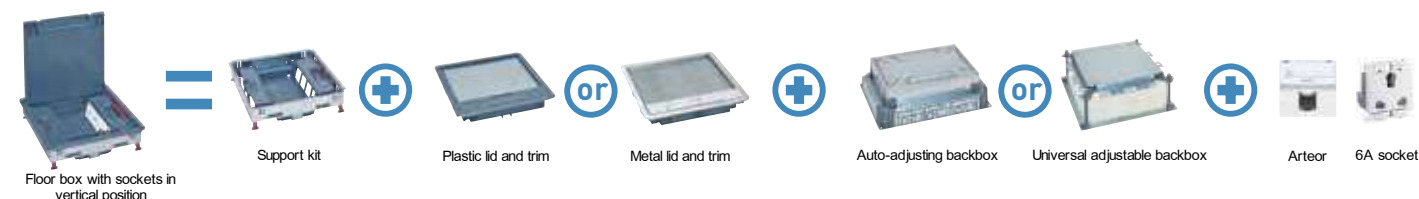
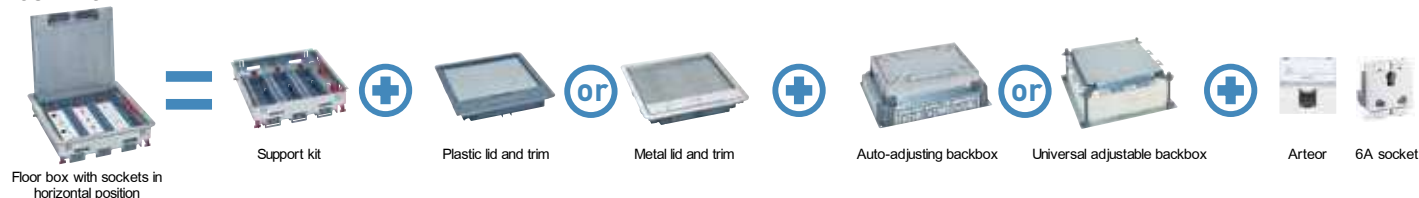

POP-UP BOXES

Our sleek new ergonomically designed pop-up boxes provide real ease of use and rapid connection solutions for mobile applications such as PCs, mobile phones, audio and video systems.



SLEEK DESIGN

Extra-slim format to blend discreetly into the office furniture or floor



Scan to know more about the product.



SAFETY AND EASE OF USE

Soft opening cover with damper and push & slide locking system



ELEGANT FINISHES

Aluminium, bronze, stainless steel, black or white - a perfect match for furniture and decor



FUNCTIONALITY AND FLEXIBILITY

Available in 3, 2x3, 4 and 2x4 modules for custom configuration or ready assembled with low and high current functions

Floor boxes 3 module for screed floor and raised floor

Cat.Nos	Description	MRP* ₹ / Unit	Pack
---------	-------------	------------------	------

Over floor trunking

Conform to Std EN 50085-2-2; For creating a link between trunking, column, mini-column, floor units or protecting cables on passageways Supplied with cover

0300 92	Floor duct 50 x 12	646	54 ⁽¹⁾
0300 11	Flat angle/floor 50x12	254	10
0300 12	Cover gasket to floor 50x12	320	10
0300 93	Floor duct 75x18	880	36 ⁽¹⁾
0300 18	Flat angle/floor 75x18	488	10
0300 19	Cover gasket/floor 50x12	342	10
0328 00	Floor duct 92x20mm	1612	20 ⁽¹⁾
0328 07	End cap for floor duct	286	10
0328 03	Cover joint for floor duct	390	10
0328 02	Flat angle for floor duct	704	5

Floor boxes 3 module for screed floor and raised floor Floor service outlet boxes - 3 modules

0896 44	Florr box 3mod	2066	1
0896 49	Flush mounting box 3mod.	1378	1

IP 66 Floor box - 4 module

Conform to EN 60670-1 and EN 60670-23 standards (when lid is closed) / IP55 (with cable exit accessory Cat.No 0880 62)

0880 61	IP/IK66 scr. Stainl.Steel fbox	22548	1
0880 64	Ip/ik66 cv stainl.Steel fl box	26488	1
0880 69	Back box fr floor box ip/ik66	4330	1
0880 62	Cable exit zamak floor box	25120	1

Floor access unit for raised floors IP 20 - IK 08

0893 07	Flr access unit,circular,alumn	9654	1
---------	--------------------------------	------	---

Pop-up type flush-mounting boxes for floor Pop-up boxes to be equipped

Equipped with "push and slide" locking system to avoid accidental opening by feet
To be equipped with Arteor socket outlets
For installation use the flush-mounting boxes for concrete floors or the kits for raised access floors

3 modules

0540 10	Popup alu 3mod	3018	1
0540 15	Popup brass 3mod	4398	1
0540 20	Popup stainless 3mod	4450	1

4 modules

0540 11	Popup alu 4mod	4052	1
0540 16	Popup brass 4mod	5210	1
0540 21	Popup stainless 4mod	5640	1
0540 26	Popup mattblack 4mod	5084	1
0540 31	Popup glossy white 4mod	5204	1

6 (2 x 3) modules

0540 12	Popup alu 6mod	6784	1
0540 17	Popup brass 6mod	9444	1
0540 22	Popup stainless 6mod	9794	1

* MRP - Maximum Retail Price Inclusive of all taxes including GST.
(1) Price in Meters; No of meters in Pack, Standard length 2 meters to be ordered in multiple of 2 meters.

Pop-up type flush-mounting boxes for floor

Cat.Nos	Description	MRP* ₹ / Unit	Pack
---------	-------------	------------------	------

8 (2 x 4) modules

0540 13	Popup alu 8mod	8398	1
0540 18	Popup brass 8mod	11334	1
0540 23	Popup stainless 8mod	12054	1
0540 28	Popup mattblack 8mod	10922	1
0540 33	Popup glossy white 8mod	10986	1

Retractable accessory for Pop Up

0540 34	Retract rj45 kit cord c6utp wh	4214	1
0540 35	Retract rj45 kit cord c6ftp wh	5892	1
0540 36	Retractable kit usb cord white	3992	1

Installation kits for raised access floors

Include an empty receptacle and fixing brackets for raised access floor tiles Compatible with:

- Cat. 6 data cabling
- Audio/video cabling

0540 05	Kit instal furniture popup3mod	1382	1
0540 06	Kit instal furniture popup4mod	1656	1
0540 07	Kit instal furniture popup6mod	2294	1
0540 08	Kit instal furniture popup8mod	2828	1

For installation of pop-up floor boxes in concrete floors

Equipped with knockouts for ø 20 and ø 25 mm conduits

Metal flush-mounting boxes

0540 00	Backbox concrete popup 3mod	370	1
0540 01	Backbox concrete popup 4mod	494	1
0540 02	Backbox concrete popup 6mod	784	1
0540 03	Backbox concrete popup 8mod	982	1

Pop-up type flush-mounting boxes for furniture Pop-up boxes to be equipped

Slim design for perfect integration into the furniture
To be equipped with Arteor socket outlets
Supplied alongwith installation kits for table top

4 modules

6540 14	Popup furn. Matt alu 4 mod	3960	1
6540 00	Popup furniture 4mod.Stainles+	5302	1
6540 01	Popup furniture 4mod.White+ins	4896	1
6540 02	Popup furniture 4mod. Black+in	4684	1

8 (2 x 4) modules

6540 15	Popup furn. Matt alu 2 x4 mod	8226	1
6540 03	Popup furniture 2x4m.Stainles+	11474	1
6540 04	Popup furniture 2x4m.White+ins	10444	1
6540 05	Popup furniture 2x4m.Black+ins	10384	1

Cable worm

0535 98	2 compartments, Length: 0.75m white colour very suitable solution for a safe and design protection of the cabling between desk and floor	6702	1
---------	--	------	---

Bold Cat.Nos are products normally available with Legrand (India) Stockists. Cat.Nos that are not bold - delivery within 4 - 8 weeks from the date of order. Bold packing quantity is our mandatory packing. Orders to be placed by Legrand (India) Stockist in multiples of the same.

THE FLOOR BOXES BRING POWER AND DATA AS CLOSE AS POSSIBLE TO THE USERS



QUICK AND EASY INSTALLATION

Installation
with the
minimum of tools!

With their snap-in installation, our floor boxes are designed for ease of installation and wiring in any situation, and make it easier to cut the final floor covering. All the floor boxes in the new range can be installed in either concrete screeds or raised floors. They can be laid under a variety of floor coverings up to 15 mm thick.

DLP-S

UNIVERSAL TRUNKING

FOR THE ESSENTIALS

- Traditional installation method with modular or with universal supports
- Compatible with all types of 45 mm mechanisms (like Arteor)

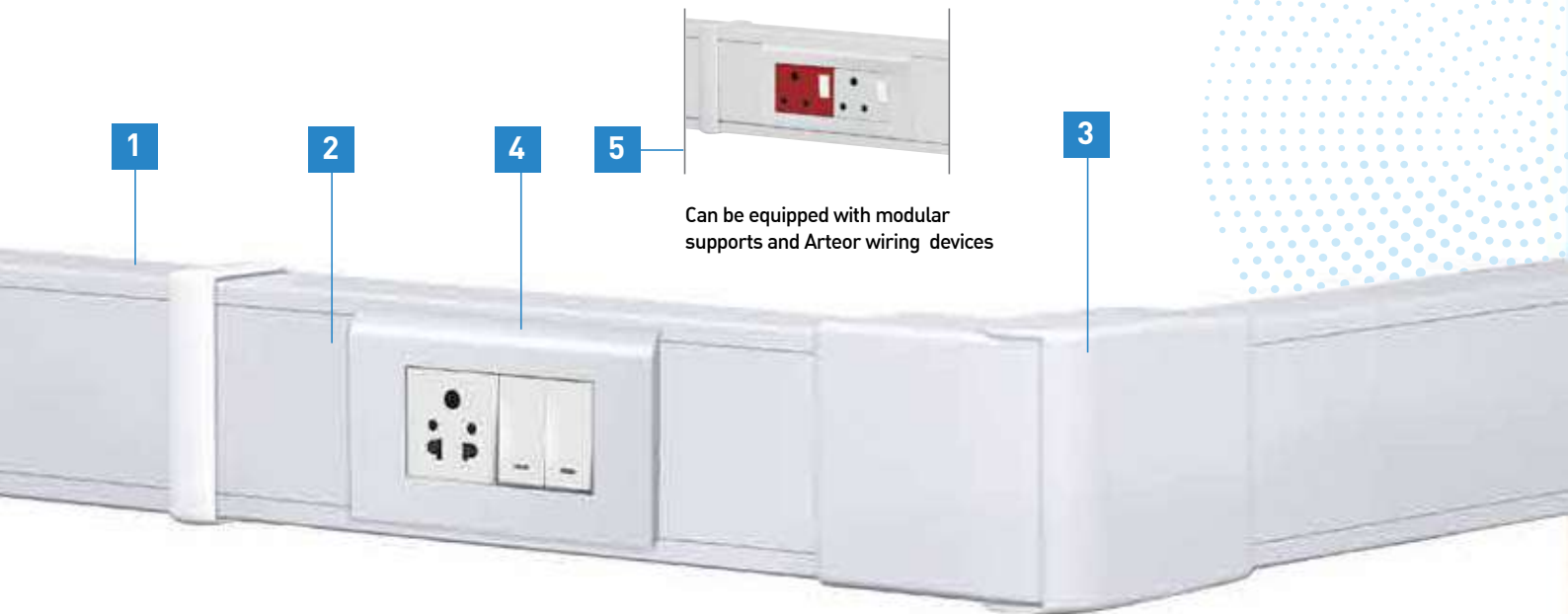

1 Rigid profiles with perforations



2 Self-guiding cover

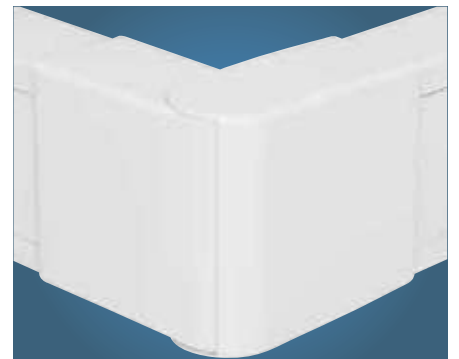

3 Ready to install accessories



Scan to know more about the product.



4 Myrius single module switch with brackets



5 Arteor sockets and modular support

snap-on trunking

routing sections and accessories

TRUNKING			TRUNKING		
Number of compartments	Cover width	Cross-section (mm)	Monobloc: body + cover ¹⁾	Divider	Fishplate body joint
SNAP-ON TRUNKING - 45 mm cover					
	45	50 x 80	○ 0756 01	0756 09	0756 61
	45	50 x 105	0756 02	0756 09	0756 62
	45 45	50 x 130	0756 03	-	0756 61
	45 45	50 x 145	0756 04	-	0756 63
	45 45 45	50 x 180	0756 06	-	0756 61

1: Partition(s) integral to the body
2: Internal and external corner angles supplied with multi-compartment partition joint

mechanisms for snap-on trunking

Mounting functions	
<p>The Arteor sockets to be fitted with Soluclip accessory which has following features:</p> <ul style="list-style-type: none"> - Anti-slip - Anti-pullout - IP 4X - Perfect finish 	 <p>0756 90</p>

Installation principle for sockets for snap-on trunking

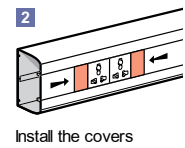
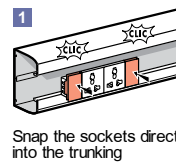

Installation principle for Arteor functions

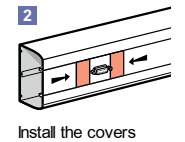
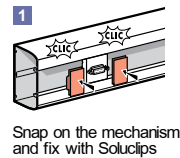

AND ACCESSORIES			ANGLES			JUNCTIONS				ACCESSORIES
Stick-on body joint	Cover joint	End cap	Internal angles ⁽²⁾	External angles	Flat angles	Flat junctions with width 80 mm	Flat junctions with width 105 mm	Angled junctions 85/105/130 mm	Junction with floor duct 50 x 12/92 x 20	Extra cover
0756 66	0756 69	0756 11	0756 21	0756 31	0756 41	0756 71	-	0756 81 + 0756 21	0756 88	0756 08
0756 67	0756 69	0756 12	0756 22	0756 32	0756 42	0756 72	0756 76	0756 81 + 0756 22	0756 88	0756 08
0756 66	2 x 0756 69	0756 13	0756 23	0756 33	0756 43	0756 71	0756 75	0756 81 + 0756 23	0756 88	0756 08
① 0756 66 + ② 0756 67	2 x 0756 69	0756 14	0756 24	0756 34	0756 44	① 0756 71 + ② 0756 72	① 0756 75 + ② 0756 76	0756 81 + 0756 24	0756 88	0756 08
0756 66	3 x 0756 69	0756 16	0756 26	0756 36	0756 46	0756 71	0756 75	0756 81 + 0756 26	0756 88	0756 08

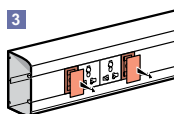

3 Disengage the finishing piece

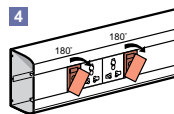

4 Rotate the finishing piece by 180°

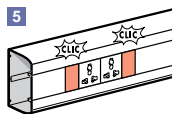

5 Snap on the finishing piece

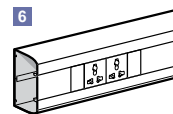

6 An impeccable result

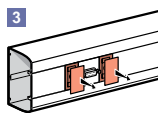

3 Disengage the finishing piece

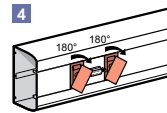

4 Rotate the finishing piece by 180°

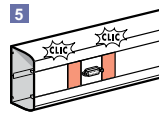



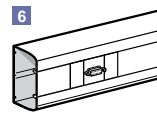

























5 Snap on the finishing piece







6 An impeccable result

DLP PVC adaptable trunking systems for installations base, covers, partitions, finishing accessories and mounting wiring accessories

Selection chart for Installation of trunking, Accessories and Arteor™

Trunking			Covers	Clip on partition		Arteor™ frames						
Number of compartments	Cover(s) width	Section (mm)										
			Flexible	Partitions separation	Plastic	Aluminium	1 module	2 module	3 module	4 module	6 module	
 0104 12	1 	80 x 50	0105 21	0105 82	-	-	-	0109 52	0109 53	0109 54	0109 56	
	2 		0105 20	0105 82	0104 72	0111 06	0109 10	-	-	-	-	
 0104 22	1 	105 x 50	0105 22	0105 82	-	-	-	0109 92	0109 93	0109 94	0109 96	
	2 		0105 20	0105 82	0104 72	0111 06	0109 10	-	-	-	-	
	2 		0105 20 + 0105 22	0105 82	0104 72	0111 06	0109 10	0109 92	0109 93	0109 94	0109 96	
	3 		0105 20	0105 82	0104 72 x 2	0111 06 x 2	0109 10	-	-	-	-	
 0104 32	1 	150 x 50	0105 24	0105 82	-	-	-	-	-	-	-	
	2 		0105 21	0105 82	0104 72	0111 06	-	0109 52	0109 53	0109 54	0109 56	
	2 		0105 20 + 0105 22	0105 82	0104 72	0111 06	0109 10	0109 92	0109 93	0109 94	0109 96	
	3 		0105 20	0105 82	0104 72 x 2	0111 06 x 2	0109 10	-	-	-	-	
	1 		195 x 50	0105 26	0105 82	-	-	-	-	-	-	-
	2 			0105 22	0105 82	0104 72	0111 06	-	0109 92	0109 93	0109 94	0109 96
2 	0105 82	0104 72		0111 06	0109 10	-	-	-	-			
3 	0105 82	0104 72 x 2		0111 06 x 2	0109 10	0109 92	0109 93	0109 94	0109 62			
3 	0105 82	0104 72 x 2		0111 06 x 2	0109 10	0109 52	0109 53	0109 54	0109 56			
4 	0105 20	0105 82		0104 72 x 3	0111 06 x 3	0109 10	-	-	-	-		

Selection chart for Installation trunking, Accessories and Arteor™

Section (mm)	Wall crossing 	Capacity change 	Partition junction 	Cable tie base 	Insulating unit for Arteor™ modules 	Earth Link
					2 Module Combined to get 4/6 Module	
80 x 50 / 105 x 50	0106 98	0106 87 + 0106 88 + 0106 89 (to be used for partition)	0106 89	0308 81	0109 27	0111 88
150 x 50 / 195 x 50	0106 99					

Selection chart for Installation of trunking, Additional accessories

Cover	Bases		Internal angles 80° - 100°			External angles 60° - 120°			Flat angles		Flat junction			
Joint for covers	Base joint	End caps	Angles	Partition junction	VDI access.	Angles	Partition junction	VDI access.	Angles	VDI access.	Angles	Partition junction	VDI access.	Clips
0108 01	0106 91	0107 22	0106 02	-	0107 80	0106 22	-	0107 81	0107 67	0107 82	0107 32	-	0107 83	0106 82
0108 02	0106 91	0107 02	0106 02	-	0107 80	0106 22	-	0107 81	0107 85	0107 82	0107 32	-	0107 83	0106 82
0108 00	0106 91	0107 02	0106 02	0106 11	-	0106 22	0106 32	-	-	-	0107 32	0107 42	-	0106 82
0108 04	0106 91	0107 03	0106 02	-	-	0106 22	-	-	0107 89	-	0107 32	-	-	0106 86
0108 01	0106 91	0107 03	0106 02	0106 11	0107 80	0106 22	0106 32	0107 81	0107 89	0107 82	0107 32	0107 42	0107 83	0106 82
0108 02	0106 91	0107 03	0106 02	0106 11	0107 80	0106 22	0106 32	0107 81	0107 89	0107 82	0107 32	0107 42	0107 83	0106 82
0108 00	0106 91	0107 03	0106 02	0106 11 x2	-	0106 22	0106 32 x2	-	0107 89	-	0107 32	0107 42	-	0106 82
0108 06	0106 91	0107 07	0106 02	-	-	0106 22	-	-	0107 92	-	0107 32	-	-	0106 86
0108 02	0106 91	0107 07	0106 02	0106 11	0107 80	0106 22	0106 32	0107 81	0107 92	0107 82	0107 32	0107 42	0107 83	0106 82
	0106 91	0107 07	0106 02	0106 11	0107 80	0106 22	0106 32	0107 81	0107 92	0107 82	0107 32	0107 42	0107 83	
	0106 91	0107 07	0106 02	0106 11 x2	0107 80	0106 22	0106 32 x2	0107 81	0107 92	0107 82	010732	0107 42	0107 83	0106 82
	0106 91	0107 07	0106 02	0106 11 x2	0107 80	0106 22	0106 32 x2	0107 81	0107 92	010782	0107 32	0107 42	010783	0106 82
0108 00	0106 91	0107 07	0106 02	0106 11 x3	-	0106 22	0106 32 x3	-	0107 92	-	0107 32	0107 42	-	0106 82

DLP mini trunking systems for cable distribution







■ Selection chart for DLP mini trunking

	Length	Finishing Accessories				Junction Elements
WHITE	2 m	End cap	Internal angle	External angle	Flat angle	Flat junction
32 x 12.5	0300 15	0312 03	0302 51	0302 51	0302 53	0302 54
32 x 16	0308 04	0312 07	0333 25	0333 25	0333 27	0333 30
32 x 20	0300 17	0312 09	0302 71	0302 71	0302 73	0302 74





DLP aluminium trunking system

selection chart of sections, covers and accessories
selection chart of support for wiring accessories

TRUNKING AND ACCESSORIES

Width (mm)		Nos. of compartments	Covers width	Cat. nos.	Rigid covers 				 Cover Joint	 Trunking Base Joint
					65 mm width	85 mm width	130 mm width	180 mm width		
105 x 50	1		1 x 85	111 00	-	0111 11	-	-	0111 63	0111 66
150 x 50	2		2 x 65	0111 02	2 x 0111 10	-	-	-	0111 62	0111 66
195 x 50	2		2 x 85	0111 04	-	2 x 0111 11	-	-	0111 63	0111 66

SUPPORT FOR WIRING ACCESSORIES

60 mm fixing centers : Arteur™		Cover depths	
No of module		65 mm	85 mm
2 modules		0112 02	0112 12
3 modules		0112 03	0112 13
4 modules		0112 04	0112 14
6 modules		0112 06	0112 16

Insulation resistance : the entire DLP range, including accessories, have insulation resistance above 5 Megaohms

DLP TRUNKING SYSTEM ALUMINIUM

with aluminium adaptable DLP trunking, get better styling too !



SELECTION CHART OF ACCESSORIES (continued)

Dividers		End cap	Internal angles	External angles	Flat angles	Junction Flat junction*	Clips	Earth link
Clip-on partition	Separation partition							
-	0111 08	0111 58	0112 21	0112 32	0112 43	0112 51	0106 82	0111 88
0111 06	0111 08	0111 60	0112 27	0112 38	0112 45	0112 51	0106 82	0111 88
0111 06	0111 08	0111 61	0112 29	0112 40	0112 47	0112 51	0106 82	0111 88

(1) To be used with angle covers. (2) To be used with rigid covers

TABLE OF CAPACITIES

	Crosssection (mm ²) Max. Ø (mm ²)	105 x 50	150 x 50		195 x 50	
		cover 85	cover 65	cover 65	cover 85	cover 85
Trunking only	Cross-section	4330	3020	3020	5350	5350
	Max. Ø	28	43	43	55	55
With Arteor / support	Cross-section	2300	1470	1470	3320	3320
	Max. Ø	2 x 24	18	18	33	33

*To tap off 105 mm wide trunking with 85 mm cover

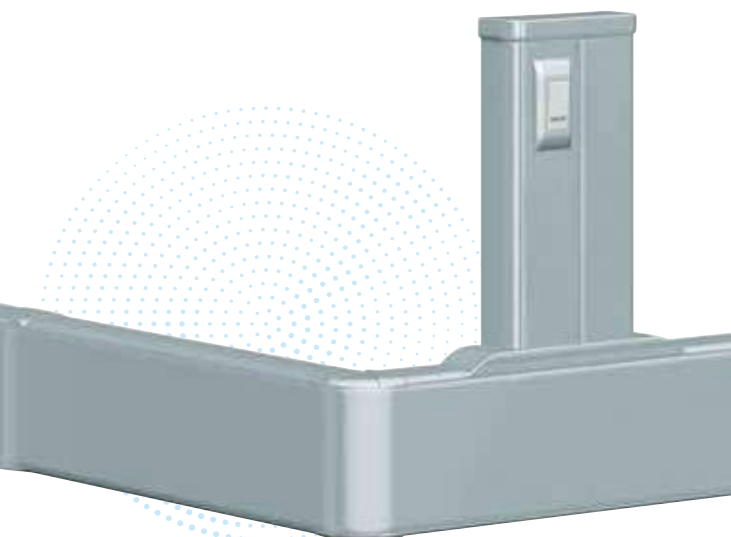

SAVE TIME

- Flexibility : multi-covers
- Removable separation
- Angles delivered pre-cut, ready to use
- Fast fixing device support
- Uniform colours for the entire installation
- Arteor™ wiring accessories go with aluminium adaptable DLP trunking

Snap-on trunking routing sections and accessories

Cat.Nos	Description	MRP* ₹ / Unit	Pack
---------	-------------	------------------	------

Snap-on trunking

Monobloc: Body + Cover, can take any Arteor wiring accessory
Standard length 2 meters; Price per meter

0756 01	TRK 50X80 1CV45 WH 2M	1374	20 ⁽¹⁾
0756 02	TRK 50X105 1CV45 WH 2M	1750	12 ⁽¹⁾
0756 03	TRK 50X130 2CV45 WH 2M	2406	12 ⁽¹⁾
0756 04	TRK 50X145 2CV45 WH 2M	3106	8 ⁽¹⁾
0756 06	TRK 50X180 3CV45 WH 2M	3420	8 ⁽¹⁾

Divider

0756 09	SEPARATION PART.TRK	304	26 ⁽¹⁾
---------	---------------------	-----	-------------------

Extra cover

0756 08	FLEXIBLE CV45MM TRK	536	20 ⁽¹⁾
---------	---------------------	-----	-------------------

Joints

Fishplate Body joint

0756 61	Coupling set 50x80/130/180	484	10
0756 62	Coupling set 50x105	642	10
0756 63	Coupling set 50x145	562	10

Stick-on body joint

0756 66	Body joint 50x80/130/145/180	314	20
0756 67	Body joint 50x105/145	380	20

Cover joint

0756 69	45mm cover joint trk	166	10
---------	----------------------	-----	----

End caps

0756 11	END CAP TRK 50X80	282	10
0756 12	END CAP TRK 50X105	282	10
0756 13	END CAP TRK 50X130	466	5
0756 14	END CAP TRK 50X145	480	5
0756 16	END CAP TRK 50X180	524	5

Height spacer

0105 80	Height spacer charcoal grey	706	24 ⁽¹⁾
---------	-----------------------------	-----	-------------------

Soluclip accessory

Fishplate body joint

0756 90	Soluclip TRK	244	10
---------	--------------	-----	----

Angles

Internal angles

0756 21	Inter angle TRK 50x80	642	10
0756 22	Inter angle TRK 50x105	894	10
0756 23	Inter angle TRK 50x130	1502	5
0756 24	Inter angle TRK 50x145	2414	5
0756 26	Inter angle TRK 50x180	2138	5

External angles

0756 31	Exter angle TRK 50x80	1340	10
0756 32	Exter angle TRK 50x105	2048	10
0756 33	Exter angle TRK 50x130	2782	5
0756 34	Exter angle TRK 50x145	3278	5
0756 36	Exter angle TRK 50x180	3888	5

Flat angles

0756 41	Flat angle trk 50x80	784	10
0756 42	Flat angle trk 50x105	1028	10
0756 43	Flat angle trk 50x130	2048	5
0756 44	Flat angle trk 50x145	1920	5
0756 46	Flat angle trk 50x180	3840	5

Snap-on trunking routing sections and accessories

Cat.Nos	Description	MRP* ₹ / Unit	Pack
---------	-------------	------------------	------

Junctions

Flat junctions with 80 mm width

0756 71	Flat junct side 17->50x80	1074	5
0756 72	Flat junct side 29->50x80	1074	5

For 105 mm wide upward trunking

0756 75	Flat junct side 17->50x105	1050	5
0756 76	Flat junct side 29->50x105	1148	5

Angled junction

Must be used in conjunction with an internal angle

0756 81	Angled function->50x80/105/130	2368	5
---------	--------------------------------	------	---

Junction with floor duct

0756 88	Floor junction->50x12/92x20	1246	5
---------	-----------------------------	------	---

DLP PVC trunking system

Mini-trunking system

Standard length 2 meters; Price per meter
Mini-trunking - 32 x 12.5 mm

0300 15	Mini trunking 32x12.5 White	146	80 ⁽¹⁾
---------	-----------------------------	-----	-------------------

Finishing accessories

0312 03	End cap for 32x12.5	80	20/400
0302 51	Flat angle for 32x12.5	110	10/100
0302 53	Flat angle for 32x12.5	122	10/100
0302 54	Flat junction for 32x12.5	160	10/200
0336 03	White 32x10/12.5 Cover gasket	158	20

Mini-trunking - 32 x 16 mm

0308 04	Mini trunking 32x16 white 2.10	192	60 ⁽¹⁾
---------	--------------------------------	-----	-------------------

Finishing accessories

0312 07	End cap for 32x16	116	10
0333 25	Int/ext. Angle for 32x16	132	10
0333 27	Flat angle for 32x16	130	10
0333 30	Flat junction for 32x16	182	10
0336 04	White 32x16/20 cover gasket	158	20

Mini-trunking - 32 x 20 mm

0300 17	Mini trunking 32x20 white 2.10	208	50 ⁽¹⁾
---------	--------------------------------	-----	-------------------

Finishing accessories

0312 09	End cap for 32x20	166	10
0302 71	Int/ext. Angle for 32x20	160	10
0302 73	Flat angle for 32x20	132	10
0302 74	Flat junction for 32x20	158	10
0336 04	White 32x16/20 cover gasket	158	20

* MRP - Maximum Retail Price Inclusive of all taxes including GST.
(1) Price in Meters; No of meters in Pack, Standard length 2 meters to be ordered in multiples of 2 meters

Bold Cat.Nos are products normally available with Legrand (India) Stockists. Cat.Nos that are not bold - delivery within 4 - 8 weeks from the date of order. Bold packing quantity is our mandatory packing. Orders to be placed by Legrand (India) Stockist in multiples of the same.

DLP PVC trunking system and accessories - trunking and fittings

Cat.Nos	Description	MRP* ₹ / Unit	Pack
---------	-------------	------------------	------

Standard length 2 meters; Price per meter Trunking

Bodies

Supplied without cover

0104 12	Plastic trunking 80mmx50mm	850	20 ⁽¹⁾
0104 22	Plastic trunking 105mmx50mm	1060	20 ⁽¹⁾
0104 32	Plastic trunking 150x50mm	1796	10 ⁽¹⁾
0104 52	Plastic trunking 195x50mm	2424	8 ⁽¹⁾

Flexible cover

Fits onto the whole branch including in internal or external angles

0105 20	Flexible cover 40mm width	432	20 ⁽¹⁾
0105 21	Flexible cover 65mm width	414	24 ⁽¹⁾
0105 22	Flexible cover 85mm width	478	20 ⁽¹⁾
0105 24	Flexible cover 130mm width	1028	8
0105 26	Flexible cover 180mm width	1312	8 ⁽¹⁾

Partitions

0105 82	Separation partitions	282	24 ⁽¹⁾
0104 72	Clip on partitions	414	48 ⁽¹⁾
0111 06	Aluminium clip on partition	1692	12 ⁽¹⁾

Joints

0106 91	Base joint	92	20/200
0108 00	Joint for 40mm width cover	198	10/100
0108 01	Joint for 65mm width cover	164	10/100
0108 02	Joint for 85mm width cover	252	10/100
0108 04	Joint for 130mm width cover	434	10/100
0108 06	Joint for 180mm width cover	400	10/100

Angles and end caps

Internal and external angles

Include the 2 components for the top and bottom of the trunking on which the flexible cover is fitted

0106 02	Internal angles-adj frm 80 deg	614	10/40
0106 22	External angles-adj frm 60 deg	600	10/50

Flat angle

0107 67	Flat angles	856	10
0107 85	Flat angles	894	10
0107 89	Flat angles	2968	5
0107 92	Flat angle for 195x50-dlp tru	3804	2

End cap

0107 02	End cap	218	20/100
0107 06	End cap	432	10/50
0107 07	End caps	512	5/50
0107 22	End cap	244	10

Junctions

0107 32	Flat junctions	1104	10
0107 35	Flat junction for specific siz	644	5
0107 36	Flat junction for specific siz	640	5/25
0107 37	Flat junction for specific siz	640	5/25

* MRP - Maximum Retail Price Inclusive of all taxes including GST.
(1) Price in Meters; No of meters in Pack, Standard length 2 meters to be ordered in multiples of 2 meters

DLP PVC trunking system and accessories - trunking and fittings

Cat.Nos	Description	MRP* ₹ / Unit	Pack
---------	-------------	------------------	------

Accessories

Holding cables in place

0106 82	Clips for 40/65/85mm width-cover	82	50
0106 86	Clips for 130mm width cover	140	50

VDI accessories

0107 80	Vdi acc for internal angles	958	5/50
0107 81	Vdi acc for flat external angle	1032	5/50
0107 82	Vdi acc for flat angles	1098	5/50
0107 83	Vdi acc for flat junctions	1320	5/50

Additional accessories

0106 98	Wall crossing	1066	5/25
0106 99	Wall crossing	1104	5/25
0308 81	Cable ties base	36	100/1000
0111 88	Earth link	408	20/500

Capacity Change

Allows to increase 15 mm height of trunking to preserve the space of wiring with a flat junction or a support equipment

0106 87	Capacity change	386	40
0106 88	Capacity change	486	10/100
0106 89	Partition junction	488	5/50

Supports for mounting wiring accessories

Arteor™ supports

To be equipped with Arteor socket outlets
Clip-on supports which can be fitted side by side
Supplied with finishing plate

0109 10	1 Arteor mod.Fra for 40mm cove	220	5/50
0109 52	2m dlp supt.Fr for 65 mm cover	214	20
0109 92	2m dlp supt.Fr for 85 mm cover	224	20
0109 53	3m arteor frame for 65mm cover	298	5/50
0109 93	3m dlp supt.Fr for 85mm cover	314	5/50
0109 54	4m dlp supt.Fr for 65 mm cover	336	10/50
0109 94	4m dlp supt.Fr for 85 mm cover	346	20
0109 56	6m dlp supt.Fr for 65 mm cover	356	5/25
0109 96	6m dlp supt.Fr for 85 mm cover	436	10
0109 27	Insu unit 2m to create 4/6/8m	376	10/100

Legrand Lexic supports

0109 25	Lexic supp for 2m for dlp 65mm	1308	5
0109 35	Lexic supp for 3m for dlp 85mm	1540	5
0109 65	Lexic supp- 8m for dlp 130mm	1734	5
0109 00	Hypra sckt supp for 130mm cove	2518	5

Bold Cat.Nos are products normally available with Legrand (India) Stockists.
Cat.Nos that are not bold - delivery within 4 - 8 weeks from the date of order.
Bold packing quantity is our mandatory packing. Orders to be placed by Legrand (India) Stockist in multiples of the same.

DLP-S PVC trunking system and accessories - trunking and fittings

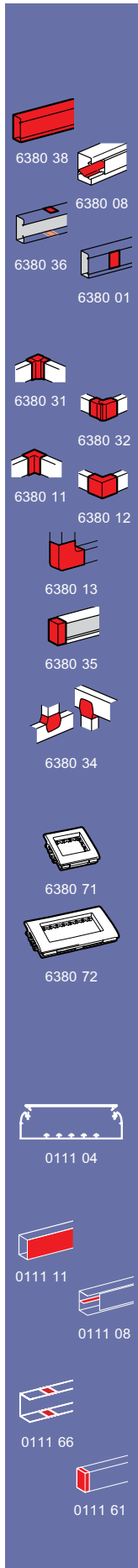

Cat.Nos	Description	MRP* ₹ / Unit	Pack
---------	-------------	------------------	------

Standard length 2 meters; Price per meter Trunking

Body with cover

6380 38	Dlp-s trunkn wit cvr100x-50mm2m	1222	12 ⁽¹⁾
---------	---------------------------------	------	-------------------

Partition

6380 08	Dlp-s separation partition	232	32 ⁽¹⁾
---------	----------------------------	-----	-------------------

Joints

6380 36	Dlp-s body joint 100x50 mm	76	10
6380 01	Dlp-s cover joint 75 mm	202	50

Angles and end caps

Variable angles

6380 31	Dlp-s variable int.Angle100x50	480	10
6380 32	Dlp-s variable ext.Angle100x50	480	10

Fixed angles

6380 11	Dlp-s fixd int angle for100x50	312	20
6380 12	Dlp-s fixd ext angle for100x50	314	20

Flat angle

6380 13	Dlp-s fixd flat angle fr100x50	680	16
---------	--------------------------------	-----	----

End cap

6380 35	Dlp-s end cap 100x50 mm	172	20
---------	-------------------------	-----	----

Bracket

6380 05	Dlp-s brackets cv80mm	144	10/100
---------	-----------------------	-----	--------

Junction

6380 34	Dlp-s tee 100x50 mm	1500	5
---------	---------------------	------	---

Supports for mounting wiring accessories

Arteor™ & Myrius supports

Clip-on supports which can be fitted side by side
Supplied with finishing plate

6380 71	Dlp-s 2 modules frame	214	10
6380 72	Dlp-s 4 modules frame	308	5
6380 73	Dlp-s 6 modules frame	438	5

DLP aluminium adaptable trunking system

Body Standard length 2 meters; Price per meter

0111 00	Aluminium trkg 105x50,w/o cove	5422	8 ⁽¹⁾
0111 02	Al trunking -150 x 50 mm	6834	4 ⁽¹⁾
0111 04	Al trunking -195 x 50	8012	4 ⁽¹⁾

Cover and partition

0111 10	Al trking -flexible cover 65mm	1362	16 ⁽¹⁾
0111 11	Aluminium cover 85mm width	1788	16 ⁽¹⁾
0111 08	Seperation partition	938	24 ⁽¹⁾
0111 06	Aluminium clip on partition	1692	12 ⁽¹⁾

Finishing accessories

0111 66	Trunking body joint	324	20/100
0111 62	Al trunking -jt for cover 65mm	444	10
0111 63	Cover joint	474	10/100
0111 58	End cap for al 105x50mm	966	20/100
0111 60	Al trunking -end caps 150x50mm	2064	10
0111 61	Al trunking -end caps 195x50mm	2452	10

* MRP - Maximum Retail Price Inclusive of all taxes including GST.
(1) Price in Meters; No of meters in Pack, Standard length 2 meters to be ordered in multiples of 2 meters

DLP aluminium adaptable trunking system - trunking and fittings



Cat.Nos	Description	MRP* ₹ / Unit	Pack
---------	-------------	------------------	------

Finishing accessories

0112 43	Flat angle	8308	10
0112 45	Flat angle	13988	5
0112 47	Flat angle	14430	2
0112 32	External angle	10356	1
0112 38	Exter.Angle 50x150 2cov.65	21450	1
0112 40	Exter.Angle 50x195 2cov.85	22390	1
0112 21	Internal angle	9318	1
0112 27	Inter.Angle 50x150 2cov.65	21292	1
0112 29	Inter.Angle 50x195 2cov.85	22240	1
0112 51	Flat junction	11282	5

Supports for Arteor™ for cover 85 mm width

To be equipped with Arteor socket outlets

0112 12	2 Arteor/mosaic module frame	672	20
0112 13	3 Arteor/mosaic module frame	792	20
0112 14	4 Arteor/mosaic module frame	794	20
0112 16	6 Module arteor frame for dlp	1062	10

Supports for Arteor™ for cover 65 mm width

To be equipped with Arteor socket outlets

0112 02	2 Module arteor frame for 65	612	20
0112 03	3 Module arteor/mosaic frame	750	20
0112 04	4 Module arteor/mosaic frame	782	20
0112 06	6 Module arteor/mosaic frame	916	10

Cabling accessories

0106 82	Clips for40/65/85mm width-cover	82	50
0111 88	Earth link	408	20
0308 81	Cable ties base	36	100

Aluminium Snap-on Columns

2 Compartments mini - columns

6530 23	Mini column 2 cpts 0.68m wh	14686	1
6530 24	Mini column 2 cpts 0.68m alu	20734	1

Accessories for 1 or 2 compartments mini-columns

6530 84	Table for mini column - white	40612	1
6530 86	Foot for mini column white	26786	1
6530 87	Foot for mini column alu	28170	1
6530 88	4 Wheels with cable holder	18488	1

Bold Cat.Nos are products normally available with Legrand (India) Stockists.
Cat.Nos that are not bold - delivery within 4 - 8 weeks from the date of order.
Bold packing quantity is our mandatory packing. Orders to be placed by Legrand (India) Stockist in multiples of the same.

Accessories for 1 or 2 compartments

NEW!

Cat.Nos	Description	MRP* ₹ / Unit	Pack
---------	-------------	------------------	------

Fixing clip

6038 57	Fixing clip	308	10
6038 58	Fixing clip	864	10

1 Compartment - 2 sides columns

White finish

6530 10	Snap-on column 1 cpt 2.70m whi	38538	1
6530 13	Snap-on column 1 cpt 3.90m wh	49592	1

Aluminium finish

6530 11	Snap-on column 1 cpt 2.70m alu	44928	1
6530 14	Snap-on column 1 cpt 3.90malu	56502	1

2 compartments columns

White finish

6530 30	Snap-on column 2 cpts 2.70m wh	37326	1
6530 33	Snap-on column 2 cpts 3.90m wh	48216	1

Aluminium finish

6530 31	Snap-on column 2 cpts 2.70malu	50112	1
6530 34	Snap-on column 2 cpts 3.90malu	64798	1

Finishing kit for telescopic pole for 1 or 2 compartments columns

6530 66	White finishing kit for column	2588	1
6530 67	Grey finishing kit for column	2770	1

Fixing clip

6038 57	Fixing clip	308	10
6038 58	Fixing clip	864	10

* MRP - Maximum Retail Price Inclusive of all taxes including GST.
(1) Price in Meters; No of meters in Pack, Standard length 2 meters to be ordered in multiples of 2 meters

www.legrand.co.in



Click to discover us

- 1** Legrand (India) - provides all information regarding the groups philosophy, products, organisation etc.
- 2** Products and solutions - complete information about our range of products for residential, commercial and industrial markets.
- 3** Downloads - download catalogues and brochures.

AUDIO/VIDEO PRETERMINATED SOCKETS

THE RIGHT SYSTEM TO MEET YOUR NEEDS

A wide range of technologies (HD15, HDMI, DISPLAY PORT, RCA, JACK) to suit the location and the user requirements

INSTALLATION EXAMPLE WITH HD15 PRETERMINATED SOCKET AND VIDEO PROJECTOR SWITCH

1 Quick
installation

2 Easy
connection

3 Optimum
performance



1 Infrared ON/STANDBY control for video projector associated with a pushbutton
Cat.No 0 787 99/5 720 89

2 3 Preterminated HD15 sockets Cat.No 0 787 77/5 720 97

4 10 m male/male HD15 cords
Cat.No 0 517 23

5 6 Male/male HD 15 cords



Scan to know more about
the product.

LCS

INNOVATIVE POWER
INFRASTRUCTURE
SOLUTIONS FOR DATA
CENTERS AND NETWORKS



IEC PDU - INTELLIGENCE AT THE HEART OF YOUR NETWORKS

CORD LOCKING SYSTEM

Innovation at the heart of PDU

1 CONNECTION

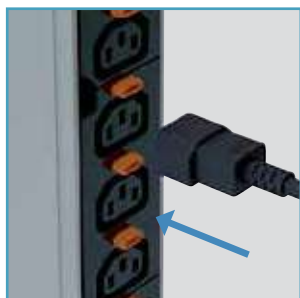

CORD CONNECTION

The cord is connected to the socket naturally in one smooth action

2 AUTO LOCKING

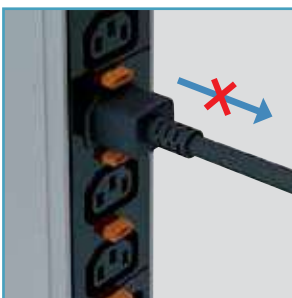

CORD HELD IN PLACE

Once the power supply cord is connected, it locks automatically and cannot be removed

3 UNLOCKING

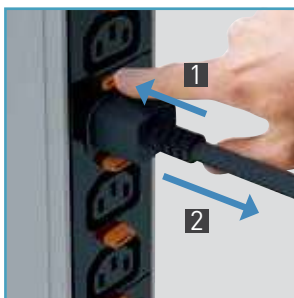

EASY REMOVAL

Simply pressing the unlock button releases the cord from the socket

A major addition to the range and exclusive to Legrand, C13 & C19 outlets have a power supply cord locking system which prevents accidental disconnection and guarantees absolute safety!

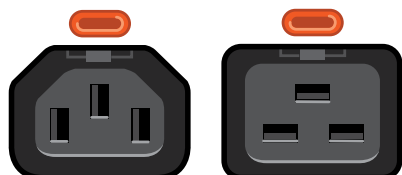

A universal system: Takes all cords for standard C13 and C19 outlets

EXCLUSIVE TO LEGRAND

OUR PDUs FEATURE EXCLUSIVE LEGRAND INNOVATIONS. THEY ARE IDENTIFIED BY THE FOLLOWING SYMBOLS



LCS³

FROM TECHNICAL ROOM TO WORKSTATION

Complete systems with a 20-year guarantee. The new LCS³ cat. 6a (up to 500 MHz), cat. 6 (up to 250 MHz) and cat. 5e (up to 100 MHz) systems have been designed as coherent entities to optimise their performance. The systems are suitable for optical fibre cables as well as copper cables.

The new LCS³ systems integrate perfectly in the various other Legrand solutions: DLP trunking system, cabling accessories, cable management, etc.



FIBRE OPTIC PANELS

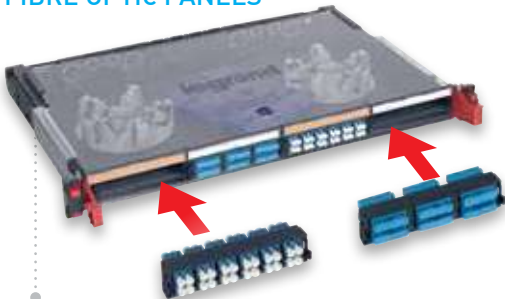

Modular panels



HD Modular panels

CORD LOCKING SYSTEM



AN INNOVATIVE TECHNICAL SOLUTION

FIBRE OPTIC SYSTEM

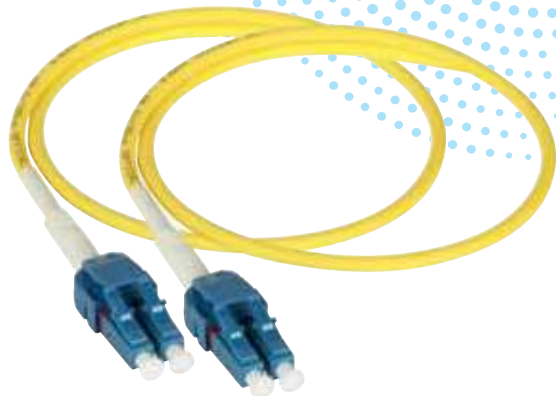

Scan to know more about the product.

NEW TOOLLESS CONNECTOR CONNECTION PHASES

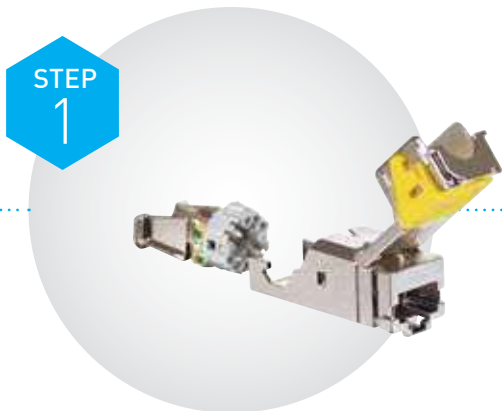

Take the wire housing

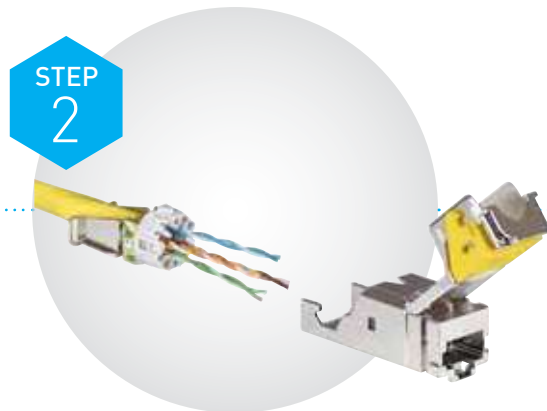

Pass the cable through the back of the wire housing

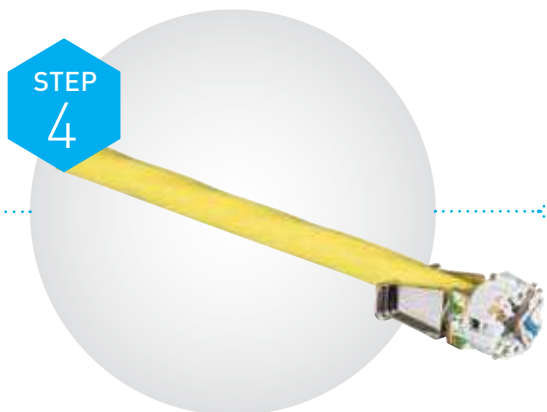

Cut the pairs

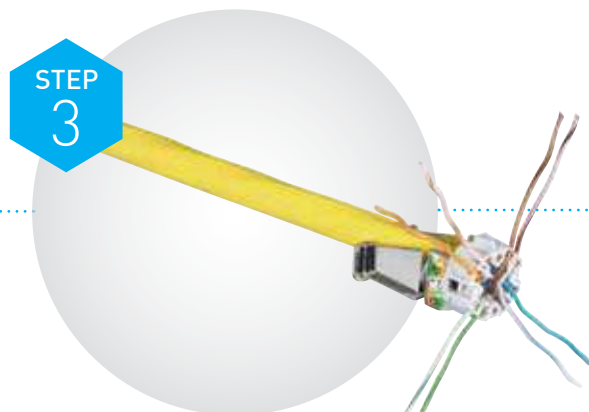

Separate and insert the pairs

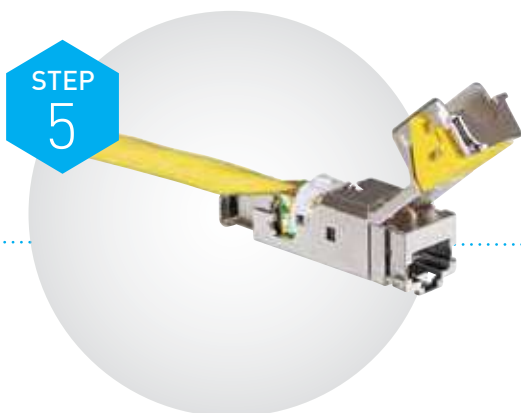

Install the wire housing without pushing

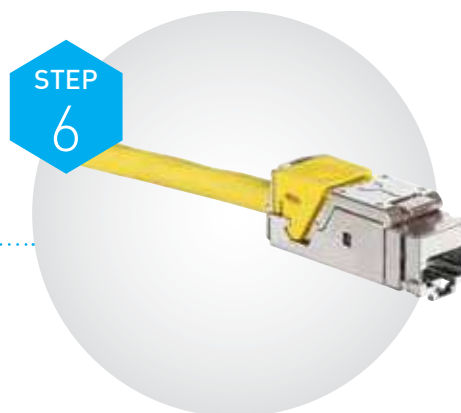

Push down the lever and lock the connector

Legrand cabling system LCS³ category 8

Cat.Nos	Description	MRP* ₹ / Unit	Pack
---------	-------------	------------------	------

Cat. 8 patch panel equipped with 24 RJ 45 connectors



Flat panel

0337 82

0337 82	STP panel - Metal shielding	■	1
---------	-----------------------------	---	---

Flat 24-connector patch panels - 1 U to be equipped



0337 90

Flat panel with empty cassettes to be equipped with connectors

Equipped with 4 automatic extraction cassette for cat. 5e to cat. 8 RJ 45 connectors

0337 90	19" patch panel - 1 U	■	1
---------	-----------------------	---	---

Empty flat panel to be equipped with cassette



0337 92

It can accept a maximum of 4 automatic extraction cassettes:

- copper
- fibre optic

0337 91	19" patch panel - 1 U	■	1
---------	-----------------------	---	---

0337 85

0337 85

Angled 24-connector patch panel - 1 U



0337 56

Angled panel to be equipped with connectors

It can accept up to 24 cat. 5e to cat. 8 RJ 45 connectors

0337 92	19" panel - 1 U	■	
---------	-----------------	---	--

0337 59

Cat. 8 RJ 45 connectors for flat and angled STP panel



0337 55

0337 85	Set of 6 RJ 45 connectors For installation in the cassettes of flat or angled panels	■	1
---------	--	---	---

Common accessories for flat and angled panels

Port blanking modules



0337 57

0337 56	Divisible 6 port blanking plate for sealing from 1 to 6 ports	■	10
---------	--	---	----

0337 58

* MRP - Maximum Retail Price Inclusive of all taxes including GST.
■ Price available on request.
(1) in meters

Legrand cabling system LCS³ category 8

Cat.Nos	Description	MRP* ₹ / Unit	Pack
---------	-------------	------------------	------

Cord management

0337 59	2 cord management for use with new generation Quick-Fix They provide side cord management	■	1
---------	--	---	---

Specific accessories for flat panels

Cassette for flat panels to be equipped

0337 55	Empty removable cassette to be equipped with connectors. It can accept 6 cat. 5e to cat. 8 connectors. Extraction by simple pressure of the cassette making installation and maintenance easier	■	1
---------	--	---	---

Blanking cassette

0337 57	Used to blank the panel	■	1
---------	-------------------------	---	---

Specific accessories for angled panels

Angled panel cover

0337 58	For optimised management of the air flow inside the cabinet	■	1
---------	---	---	---

Cat. 8 local network cables

F/UTP - 4 pairs

Performance 2000 MHz

0337 86	Length 500 m supplied on drum. Weight 42 kg	■	500 ¹
---------	--	---	------------------

S/FTP - 4 pairs

Performance 2000 MHz

0337 88	Length 500 m supplied on drum. Weight 45 kg	■	500 ¹
---------	--	---	------------------

Bold Cat.Nos are products normally available with Legrand (India) Stockists.
Cat.Nos that are not bold - delivery within 4 - 8 weeks from the date of order.
Bold packing quantity is our mandatory packing. Orders to be placed by
Legrand (India) Stockist in multiples of the same.

Legrand cabling system LCS³ category 6_A

Cat.Nos	Description	MRP* ₹ / Unit	Pack
---------	-------------	---------------------	------

Cat. 8 RJ 45 patch cords

S/FTP shielded, impedance 100 Ω

LSZH - RAL 6027

0337 01	Length 0.5 m	■	
0337 02	Length 1 m	■	
0337 03	Length 2 m	■	
0337 04	Length 3 m	■	
0337 05	Length 5 m	■	
0337 06	Length 8 m	■	
0337 07	Length 10 m	■	

LSZH - RAL 3020

0337 21	Length 0.5 m	■	1
0337 22	Length 1 m	■	
0337 23	Length 2 m	■	
0337 24	Length 3 m	■	
0337 25	Length 5 m	■	
0337 26	Length 8 m	■	
0337 27	Length 10 m	■	1

* MRP - Maximum Retail Price Inclusive of all taxes including GST.
■ Price available on request.
(1) in meters

Legrand cabling system LCS³ category 6

Cat.Nos	Description	MRP* ₹ / Unit	Pack
---------	-------------	---------------------	------

LSZH - RAL 6026

0337 08	Length 0.5 m	■	1
0337 09	Length 1 m	■	
0337 10	Length 2 m	■	
0337 11	Length 3 m	■	
0337 12	Length 5 m	■	
0337 13	Length 8 m	■	
0337 17	Length 10 m	■	1

Marking kit

0518 90	Kit of 200 coloured rings for marking RJ 45 cords Rings to be clipped to the patch cords	■	1
---------	---	---	---

Legrand cabling system LCS³ category 6_A

Cat. 6_A patch panels equipped with
24 RJ 45 connectors

Flat panels

24 RJ 45 connectors - 1 U

0337 70	UTP	■	1
0337 72	STP	■	1

Bold Cat.Nos are products normally available with Legrand (India) Stockists.
Cat.Nos that are not bold - delivery within 4 - 8 weeks from the date of order.
Bold packing quantity is our mandatory packing. Orders to be placed by
Legrand (India) Stockist in multiples of the same.

Legrand cabling system LCS³ category 6_A

Cat.Nos	Description	MRP* ₹ / Unit	Pack
---------	-------------	------------------	------

Flat 24-connector patch panels - 1 U to be equipped

Flat panel with empty cassettes to be equipped with connectors

Equipped with 4 automatic extraction cassettes for cat. 5e to cat. 8 RJ 45 connectors

0337 90	19" panel - 1 U	■	1
---------	-----------------	---	---

Empty flat panel to be equipped with cassettes

It can accept a maximum of 4 automatic extraction cassettes:
- copper
- fibre optic

0337 91	19" panel - 1 U	■	1
---------	-----------------	---	---

Flat high density 48-connector patch panel - 1 U to be equipped

0 337 93	19" panel - 1 U	■	1
----------	-----------------	---	---

Angled 24-connector patch panel - 1 U

Angled panel to be equipped with connectors

It can accept up to 24 cat. 5e to cat. 8 RJ 45 connectors

0337 92	19" panel - 1 U	■	1
---------	-----------------	---	---

Angled high density 48-connector patch panel - 1 U to be equipped

Angled panel to be equipped with connectors

It can accept up to 48 cat. 5e to cat. 6A RJ 45 connectors

0337 94	19" panel - 1 U	■	1
---------	-----------------	---	---

High density cat. 6A RJ 45 connectors

0337 73	UTP	■	1
0337 75	STP	■	1

Common accessories for flat and angled panels

Port blanking modules

0337 56	Divisible 6 port blanking plate for sealing from 1 to 6 ports	■	10
---------	---	---	----

Cord management

0337 59	For use with new generation Quick-Fix; they provide side cord management	■	1
---------	--	---	---

Specific accessories for flat panels

Cassette for flat panels to be equipped

0337 55	Empty removable cassette to be equipped with connectors. It can accept 6 cat. 5e to cat. 8 connectors Extraction by simple pressure of the cassette making installation and maintenance easier Possibility of removing each connector individually	■	1
---------	--	---	---

* MRP - Maximum Retail Price Inclusive of all taxes including GST.

■ Price available on request.

(1) in meters

Legrand cabling system LCS³ category 6_A

Cat.Nos	Description	MRP* ₹ / Unit	Pack
---------	-------------	------------------	------

High density cassette for flat panels to be equipped

0337 95	Empty removable cassette to be equipped with connectors; it can accept 12 cat. 5e to cat. 6 _A connectors Extraction by simple pressure of the cassette, making installation and maintenance easier	■	1
---------	--	---	---

Blanking cassette

0337 57	Used to blank the panel	■	1
---------	-------------------------	---	---

Specific accessories for angled panels

Angled panel cover

0337 58	For optimised management of the air flow inside the cabinet	■	1
---------	---	---	---

Cables for local networks cat. 6A

LSZH - U/UTP - 4 pairs

Performance 500 MHz

0327 87	Length 500 m Supplied on reel. Weight 25 kg	■	500 ¹
---------	---	---	------------------

F/UTP - 4 pairs

Performance 500 MHz

0327 78	Length 500 m Supplied on reel. Weight 25 kg	■	500 ¹
---------	---	---	------------------

F/UTP - 2 x 4 pairs

Performance 500 MHz

0328 78	Length 500 m Supplied on reel. Weight 65 kg	■	500 ¹
---------	--	---	------------------

S/FTP - 4 pairs

Performance 600 MHz

0327 77	Length 500 m Supplied on reel. Weight 30 kg	■	500 ¹
---------	--	---	------------------

RJ 45 patch cords and user cords cat. 6A

PVC - U/UTP unshielded impedance 100 Ω

0518 82	Length 1 m	■	1
0518 83	Length 2 m	■	1
0518 84	Length 3 m	■	1
0518 85	Length 5 m	■	1

LSZH - U/UTP unshielded impedance 100 Ω

0518 78	Length 1 m	■	1
0518 79	Length 2 m	■	1
0518 80	Length 3 m	■	1
0518 81	Length 5 m	■	1
0518 74	Length 1 m	■	1
0518 75	Length 2 m	■	1
0518 76	Length 3 m	■	1
0518 77	Length 5 m	■	1

PVC - S/FTP shielded impedance 100 Ω

0518 16	Length 0.5 m	■	1
0517 80	Length 1 m	■	5
0517 81	Length 2 m	■	5
0517 82	Length 3 m	■	5
0517 83	Length 5 m	■	5

Bold Cat.Nos are products normally available with Legrand (India) Stockists. Cat.Nos that are not bold - delivery within 4 - 8 weeks from the date of order. Bold packing quantity is our mandatory packing. Orders to be placed by Legrand (India) Stockist in multiples of the same.



0337 57



0337 58

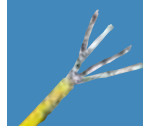

0327 77



0517 82

0337 90

0337 93

0337 92

0337 94

0337 75

0337 56

0337 59

0337 55

Legrand cabling system LCS³ category 6_A

Cat.Nos	Description	MRP* ₹ / Unit	Pack
---------	-------------	------------------	------

LSZH - S/FTP shielded impedance 100 Ω

0518 70	Length 1 m	■	1
0518 71	Length 2 m	■	1
0518 72	Length 3 m	■	1
0518 73	Length 5 m	■	1
0518 66	Length 1 m	■	1
0518 67	Length 2 m	■	1
0518 68	Length 3 m	■	1
0518 69	Length 5 m	■	1

Arteor RJ 45 socket cat. 6_A

360° metal shielding

STP - 1 module

5734 32	White	■	20
5728 06	Magnesium	■	10
5723 52	White with green shutter	■	10
5728 52	Magnesium with green shutter	■	10
5723 51	White with orange shutter	■	10
5728 51	Magnesium with orange shutter	■	10

STP with controlled access - 2 modules

Supplied with 2 keys for 5 sockets

5723 50	White with red shutter	■	5
5728 50	Magnesium with red shutter	■	5

UTP - 1 module

5723 49	White	■	10
5728 49	Magnesium	■	10
5723 59	White with green shutter	■	10
5728 59	Magnesium with green shutter	■	10
5723 58	White with orange shutter	■	10
5728 58	Magnesium with orange shutter	■	10

UTP with controlled access - 2 modules

Supplied with 2 keys for 5 sockets

5723 57	White with red shutter	■	5
5728 57	Magnesium with red shutter	■	5

Legrand cabling system LCS³ category 6

Cat. 6 patch panels equipped with 24 RJ 45 connectors

Flat panels

24 RJ 45 connectors - 1 U

0337 60	UTP	■	1
0337 61	FTP	■	1
0337 62	STP	■	1

Flat 24-connector patch panels - 1 U to be equipped

Flat panel with empty cassettes to be equipped with connectors

Equipped with 4 automatic extraction cassettes for cat. 5e to cat. 8 RJ 45 connectors

0337 90	19" panel - 1 U	■	1
---------	-----------------	---	---

* MRP - Maximum Retail Price Inclusive of all taxes including GST.

■ Price available on request.

(1) in meters

Legrand cabling system LCS³ category 6

Cat.Nos	Description	MRP* ₹ / Unit	Pack
---------	-------------	------------------	------

Empty flat panel to be equipped with cassettes

It can accept a maximum of 4 automatic extraction cassettes:
- copper
- fibre optic

0337 91	19" patch panel - 1 U	■	1
---------	-----------------------	---	---

Flat high density 48-connector patch panel - 1 U to be equipped

0337 93	19" panel - 1 U	■	1
---------	-----------------	---	---

Angled 24-connector patch panels - 1 U

Angled panel to be equipped with connectors

It can accept up to 24 cat. 5e to cat. 8 RJ 45 connectors

0337 92	19" panel - 1 U	■	1
---------	-----------------	---	---

Angled high density 48-connector patch panel - 1 U to be equipped

Angled panel to be equipped with connectors

It can accept up to 48 cat. 5e to cat. 6_A RJ 45 connectors

0337 94	19" panel - 1 U	■	1
---------	-----------------	---	---

Cat. 6 high density RJ 45 connectors

0337 63	UTP	■	1
0337 64	FTP	■	1
0337 65	STP	■	1

Common accessories for flat and angled panels

Port blanking modules

0337 56	Divisible 6 port blanking plate for sealing from 1 to 6 ports	■	10
---------	---	---	----

Cord management

0337 59	For use with new generation Quick-Fix; they provide side cord management	■	1
---------	--	---	---

Specific accessories for flat panels

0337 55	Cassette for flat panels to be equipped	■	1
0337 95	High density cassette for flat panels to be equipped	■	1
0337 57	Blanking cassette Used to blank the panel	■	1

Specific accessories for angled panels

Angled panel cover

0337 58	For optimised management of the air flow inside the cabinet	■	1
---------	---	---	---

Bold Cat.Nos are products normally available with Legrand (India) Stockists. Cat.Nos that are not bold - delivery within 4 - 8 weeks from the date of order. Bold packing quantity is our mandatory packing. Orders to be placed by Legrand (India) Stockist in multiples of the same.



5734 32



5723 57



0337 61



0337 90



0337 93

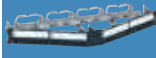

0337 92



0337 94



0337 63



0337 56



0337 59



0337 55



0337 57

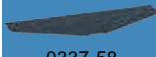

0337 58

Legrand cabling system LCS³ category 6

Cat.Nos	Description	MRP* ₹ / Unit	Pack
---------	-------------	------------------	------

Cables for cat. 6 LANs

Cables with 4 pairs or 2 x 4 twisted pairs
100 ohms. Colour code TIA/EIA
Conform to standards ISO/IEC 11801
Ed. 2.0, EN 50173-1 and TIA/EIA 568 C

LSZH - U/UTP - 4 pairs

0327 54I	Length 305 m. Supplied in cardboard box Weight 16 kg., Violet RAL 4005	■	305 ¹
0328 61	Length 500 m. Supplied on reel. Weight 18 kg. Blue RAL 5015	■	500 ¹

PVC - U/UTP - 4 pairs

0327 55W	Length 305 m Supplied in cardboard box, Weight 13 kg., White RAL 9003, MOQ 50 Box	■	305 ¹
0327 55	Length 305 m Supplied in cardboard box Weight 13 kg. Blue RAL 5015	■	305 ¹
0327 55O	Length 305 m Supplied in cardboard box, Weight 13 kg., Orange RAL 2008, MOQ 50 Box	■	305 ¹
0327 55G	Length 305 m Supplied in cardboard box, Weight 13 kg., Green RAL 6018/6024, MOQ 50 Box	■	305 ¹

LSZH - U/UTP - 4 pairs

0327 54I	Length 305 m Supplied in cardboard box. Weight 16 kg	■	305 ¹
0328 61	Length 500 m Supplied on reel. Weight 18 kg	■	500 ¹

PVC - U/UTP - 4 pairs

0327 55	Length 305m Supplied in cardboard box. Weight 13 kg	■	305 ¹
---------	---	---	------------------

LSZH - F/UTP - 4 pairs

0328 56	Length 305 m. Supplied on reel. Weight 17 kg	■	305 ¹
0327 56	Length 500 m. Supplied on reel. Weight 25 kg	■	500 ¹

PVC - F/UTP - 4 pairs

0328 57	Length 305 m Supplied in cardboard box. Weight 17 kg	■	305 ¹
0327 58	Length 500 m Supplied on reel. Weight 25 kg	■	500 ¹

LSZH - F/UTP - 2 x 4 pairs

0327 76	Length 500 m. Supplied on reel. Weight 48 kg	■	500 ¹
---------	---	---	------------------

LSZH - SF/UTP - 4 pairs

0327 57	Length 500 m. Supplied on reel. Weight 29 kg	■	500 ¹
---------	---	---	------------------

PVC - SF/UTP - 4 pairs

0327 59	Length 500 m. Supplied on reel. Weight 30 kg	■	500 ¹
---------	---	---	------------------

* MRP - Maximum Retail Price Inclusive of all taxes including GST.

■ Price available on request.

(1) in meters

Legrand cabling system LCS³ category 6

Cat.Nos	Description	MRP* ₹ / Unit	Pack
---------	-------------	------------------	------

LSZH - F/FTP - 2 x 4 pairs

0327 98	Length 500 m. Weight 62 kg	■	
---------	----------------------------	---	--

PVC - F/FTP - 4 pairs

0327 99	Length 500 m. Weight 25,2 kg	■	
---------	------------------------------	---	--

RJ 45 patch cords and user cords cat. 6

RJ 45 - RJ 45 right

PVC - U/UTP unscreened impedance 100 Ω

0518 18	Length 0.5 m	■	1
0517 72	Length 1 m	■	1
0517 73	Length 2 m	■	1
0517 74	Length 3 m	■	1
0517 75	Length 5 m	■	1

LSZH - U/UTP unscreened impedance 100 Ω

0518 62	Length 1 m	■	1
0518 63	Length 2 m	■	1
0518 64	Length 3 m	■	1
0518 65	Length 5 m	■	1
0518 58	Length 1 m	■	1
0518 59	Length 2 m	■	1
0518 60	Length 3 m	■	1
0518 61	Length 5 m	■	1

PVC - F/UTP screened impedance 100 Ω

0518 15	Length 0.5 m	■	1
0517 62	Length 1 m	■	1
0517 63	Length 2 m	■	1
0517 64	Length 3 m	■	1
0517 65	Length 5 m	■	1

LSZH - F/UTP screened impedance 100 Ω

0518 54	Length 1 m	■	1
0518 55	Length 2 m	■	1
0518 56	Length 3 m	■	1
0518 57	Length 5 m	■	1
0518 50	Length 1 m	■	1
0518 51	Length 2 m	■	1
0518 52	Length 3 m	■	1
0518 53	Length 5 m	■	1

PVC - SF/UTP shielded impedance 100 Ω

0517 52	Length 1 m	■	5
0517 53	Length 2 m	■	5
0517 54	Length 3 m	■	5
0517 55	Length 5 m	■	5

Bold Cat.Nos are products normally available with Legrand (India) Stockists.
Cat.Nos that are not bold - delivery within 4 - 8 weeks from the date of order.
Bold packing quantity is our mandatory packing. Orders to be placed by
Legrand (India) Stockist in multiples of the same.

Legrand cabling system LCS³ category 6

Cat.Nos	Description	MRP* ₹ / Unit	Pack
---------	-------------	------------------	------

RJ 45 sockets

Sockets with LCS³ quick-fixing crimp connector. Take AWG 22 single-core cables up to AWG 26 and AWG 24 multicore cables. Contacts marked with dual colour code and wiring schemes T 568 A and T 568 B. Conforming to standards ISO/IEC 11801 Ed. 2.0, EN 50173-1 and TIA/EIA 568

Arteor RJ 45 socket cat. 6

UTP - 1 module

5734 28	White	■	20
5736 28	Magnesium	■	20
5723 54	White with orange shutter	■	10
5728 54	Magnesium with orange shutter	■	10
5723 55	White with green shutter	■	10
5728 55	Magnesium with green shutter	■	10

UTP - 2 modules

5734 74	White	■	10
5736 74	Magnesium	■	10

UTP - 2 modules - round

5723 24	White	■	10
5728 24	Magnesium	■	10

UTP with controlled access - 2 modules

Supplied with 2 keys for 5 sockets

5723 53	White with red shutter	■	5
5728 53	Magnesium with red shutter	■	5

UTP retractable RJ 45 sockets - 4 modules

With integrated retractable cord (0.9 m)
Winds up automatically with a pushbutton

5723 39	White	■	1
5728 39	Magnesium	■	1

FTP - 1 module

5723 22	White	■	10
5728 22	Magnesium	■	10

FTP - 2 modules

5734 76	White	■	10
5736 76	Magnesium	■	10

Shielded STP - 1 module

5734 34	White	■	10
5736 34	Magnesium	■	10

Shielded STP - 2 modules

5734 77	White	■	10
5736 77	Magnesium	■	10

Mylic RJ 45 socket cat. 6

UTP - 1 module

6755 45	White	■	20
---------	-------	---	----

* MRP - Maximum Retail Price Inclusive of all taxes including GST.

■ Price available on request.

(1) in meters



5736 28



5728 24



6755 45

Legrand cabling system LCS³ category 6

Cat.Nos	Description	MRP* ₹ / Unit	Pack
---------	-------------	------------------	------

Myrius RJ 45 sockets cat. 6

UTP - 1 module

6730 55	White	■	20
6731 55	Black	■	20

UTP - 2 modules

6730 56	White	■	20
6731 56	Black	■	20

Soliroc RJ 45 sockets cat. 6 - IK 10

0778 91	IP 20 For at-risk areas or areas with no surveillance FTP socket	■	10
---------	---	---	----

Plexo RJ 45 sockets cat. 6 - IP 55 closed flap IK 07

Protection against water, dust. For industrial sites

0695 69	FTP socket Grey/white	■	5/100
0695 61	UTP socket Grey/white	■	1/20
0695 81	Adaptor for RJ 45 socket Weatherproofing ensured (IP 44) plug inserted Grey/white	■	1

Plexo 66 RJ 45 socket cat. 6 - IP 66 - IK 08

FTP socket

0904 67	9 contacts Weatherproofing ensured (IP 66) with plug inserted Inclined 90° Grey RAL 7016/T029	■	1
---------	---	---	---

Patch panels cat. 6

6327 91	24 x RJ 45 connectors, for unshielded keystone	■	1
---------	--	---	---

Keystone RJ 45 sockets cat. 6

0765 88	Cat 6 UTP socket with fast connection thanks to integrated crimping	■	10
---------	---	---	----

Surface mounting box

1 or 2 ports

6327 79	For keystone connectors Provides solution for integration of keystone in surface mounting installations	■	20
---------	--	---	----

Cables for cat 6 LANs 24 AWG

U/UTP - 4 Pairs

6327 24	Length 305 m Supplied in cardboard box Weight 16 kg. Dark grey RAL 7037	■	305
6327 24W	Length 305 m Supplied in cardboard box Weight 16 kg. White RAL 9003. MOQ - 50 box	■	305
6327 24O	Length 305 m Supplied in cardboard box Weight 16 kg. Orange RAL 2008 MOQ 50 Box	■	305
6327 24G	Length 305 m Supplied in cardboard box Weight 16 kg. Green RAL 6018 / 6024 MOQ 50 Box	■	305



6730 56



0778 91



0695 69



0904 67



6327 91



0765 88

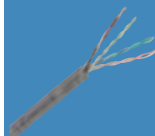

6327 24

Bold Cat.Nos are products normally available with Legrand (India) Stockists. Cat.Nos that are not bold - delivery within 4 - 8 weeks from the date of order. Bold packing quantity is our mandatory packing. Orders to be placed by Legrand (India) Stockist in multiples of the same.

Legrand cabling system LCS³ category 6

Cat.Nos	Description	MRP* ₹ / Unit	Pack
---------	-------------	------------------	------

Patch cords

RJ 45 - RJ 45
PVC



0337 51

U/UTP cat. 6 unscreened impedance 100 Ω

Light blue

6327 50	Length 1 m	■	20
6327 51	Length 1.5 m	■	20
6327 52	Length 2 m	■	20
6327 53	Length 3 m	■	20
6327 54	Length 5 m	■	20

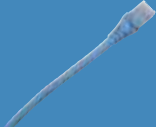

6327 50



0337 90

F/UTP cat. 6 screened impedance 100 Ω

Blue-green

6327 60	Length 1 m	■	20
6327 61	Length 2 m	■	20
6327 62	Length 3 m	■	20
6327 63	Length 5 m	■	20



6327 60



0337 93

Legrand cabling system LCS³ category 5e

Cat. 5e patch panels equipped with 24 RJ 45 connectors

Flat panel with empty cassettes to be equipped with connectors



0337 92

24 RJ 45 connectors - 1 U

0337 50	UTP	■	1
0337 51	FTP	■	1



0337 94

Flat 24-connector patch panels - 1 U to be equipped

Flat panel with empty cassettes to be equipped with connectors



0337 53

Equipped with 4 automatic extraction cassettes for cat. 5e to cat. 8 RJ 45 connectors

0337 90	19" panel - 1 U	■	1
---------	-----------------	---	---



0337 56

Empty flat panel to be equipped with cassettes

It can accept a maximum of 4 automatic extraction cassettes:
- copper
- fibre optic

0337 91	19" panel - 1 U	■	1
---------	-----------------	---	---



0337 59

Flat high density 48-connector patch panel - 1 U to be equipped

0337 93	19" panel - 1 U	■	1
---------	-----------------	---	---



0337 55

Angled 24-connector patch panel - 1 U

Angled panel to be equipped with connectors



0337 57

It can accept up to 24 cat. 5e to cat. 8 RJ 45 connectors

0337 92	19" panel - 1 U	■	1
---------	-----------------	---	---



0337 58

Angled high density 48-connector patch panel - 1 U to be equipped

0337 94	19" panel - 1 U	■	1
---------	-----------------	---	---

* MRP - Maximum Retail Price Inclusive of all taxes including GST.

■ Price available on request.

(1) in meters

Legrand cabling system LCS³ category 5e

Cat.Nos	Description	MRP* ₹ / Unit	Pack
---------	-------------	------------------	------

Cat. 5e High density RJ 45 connectors

0337 53	UTP	■	1
0337 54	FTP	■	1

Common accessories for flat and angled panels

Port blanking modules

0337 56	Divisible 6 port blanking plate for sealing from 1 to 6 ports	■	10
---------	---	---	----

Cord management

0337 59	For use with new generation Quick-Fix They provide side cord management	■	1
---------	---	---	---

Specific accessories for flat panels

0337 55	Cassette for flat panels to be equipped	■	1
0337 95	High density cassette for flat panels to be equipped	■	1
0337 57	Blanking cassette Used to blank the panel	■	1

Specific accessories for angled panels

Angled panel cover

0337 58	For optimised management of the air flow inside the cabinet	■	1
---------	---	---	---

Cables for local networks cat. 5e

LSZH - U/UTP - 4 pairs

0327 50	Length 305 m Supplied in cardboard box. Weight 16 kg	■	305 ¹
0328 53	Length 500 m Supplied on reel. Weight 15 kg	■	500 ¹

PVC - U/UTP - 4 pairs

0327 51	Length 305 m Supplied in cardboard box. Weight 9 kg	■	305 ¹
---------	---	---	------------------

LSZH - F/UTP - 4 pairs

0327 52	Length 305 m Supplied in cardboard box. Weight 12 kg	■	305 ¹
0328 50	Length 500 m Supplied on reel. Weight 21 kg	■	500 ¹

PVC - F/UTP - 4 pairs

0327 53	Length 305 m Supplied by box. Weight 11 kg	■	305 ¹
---------	--	---	------------------

RJ 45 patch cords and user cords cat. 5e

RJ 45 - RJ 45 right

PVC - U/UTP unscreened impedance 100 Ω

Grey

0518 17	Length 0.5 m	■	1
0516 36	Length 1 m	■	1
0516 37	Length 2 m	■	1
0516 38	Length 3 m	■	1
0516 39	Length 5 m	■	1

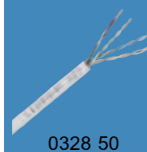

0328 50

Bold Cat.Nos are products normally available with Legrand (India) Stockists. Cat.Nos that are not bold - delivery within 4 - 8 weeks from the date of order. Bold packing quantity is our mandatory packing. Orders to be placed by Legrand (India) Stockist in multiples of the same.

Legrand cabling system LCS³ category 5e

Cat.Nos	Description	MRP* ₹ / Unit	Pack
---------	-------------	------------------	------

F/UTP screened impedance 100 Ω

Grey

0518 14	Length 0.5 m	■	1
0516 40	Length 1 m	■	1
0516 41	Length 2 m	■	1
0516 42	Length 3 m	■	1
0516 43	Length 5 m	■	1

Myrius RJ 45 sockets cat. 5e

UTP - 1 module

6730 54	White	■	20
6731 54	Black	■	20

Mylic RJ 45 sockets cat. 5e

UTP - 1 module

6755 47	White	■	20
---------	-------	---	----

Arteor RJ 45 socket cat. 5e

UTP - 1 module

5734 29	White	■	20
5736 29	Magnesium	■	20

UTP - 2 modules

5734 75	White	■	10
5736 75	Magnesium	■	20

FTP - 1 module

5734 30	White	■	20
5736 30	Magnesium	■	20

Plexo RJ 45 sockets, cat. 5e - IP 55 closed flap IK 07

Protection against water, dust
For industrial sites

0695 57	FTP socket Grey/White	■	1/20
0695 56	UTP socket Grey/White	■	1/20
0695 81	Adaptor for RJ 45 socket Ensures weatherproofing (IP 44) with the plug inserted Grey/White	■	1

Patch panels cat. 5e

6327 91	24 x RJ 45 connectors, for unshielded keystone	■	1
---------	--	---	---

Keystone RJ 45 sockets cat. 5e

0765 87	Cat 5e UTP socket with fast connection thanks to integrated crimping	■	10
---------	--	---	----

Surface mounting box

1 or 2 ports

6327 79	For keystone connectors Provides solution for integration of keystone in surface mounting installations	■	20
---------	--	---	----

* MRP - Maximum Retail Price Inclusive of all taxes including GST.

■ Price available on request.

(1) in meters

Legrand cabling system LCS³ category 5e

Cat.Nos	Description	MRP* ₹ / Unit	Pack
---------	-------------	------------------	------

Patch cords

RJ 45 - RJ 45 - PVC

U/UTP cat. 5e unscreened impedance 100 Ω

Light pink

6327 30	Length 1 m	■	20
6327 31	Length 1.5 m	■	20
6327 32	Length 2 m	■	20
6327 33	Length 3 m	■	20
6327 34	Length 5 m	■	20

F/UTP cat. 5e screened impedance 100 Ω

Light brown

6327 40	Length 1 m	■	20
6327 41	Length 2 m	■	20
6327 42	Length 3 m	■	20
6327 43	Length 5 m	■	20

Legrand cabling system LCS³ doubler sockets, adaptors and accessories

RJ 45 doubler sockets

Arteor - Telephone/Ethernet

5723 36	FTP - 9 contacts - White	■	10
5728 36	FTP - 9 contacts - Magnesium	■	10
5723 35	UTP - 8 contacts - White	■	10
5728 35	UTP - 8 contacts - Magnesium	■	10

Mobile doublers

Clip into RJ 45 sockets to double applications

0327 83	TV/computer network or telephone double connector	■	10
0327 47	Telephone/telephone doubler	■	10
0327 45	Computer network/telephone doubler	■	10
0327 46	L1/L2 telephone doubler	■	10
0327 48	Computer network/computer network double connector	■	10

Weatherproof adaptors

IP 55 - IK 07 - Allow all functions to be adapted
2 Mosaic modules IP 55 operation

Grey/White

0695 80	Adaptor with smoked flap	■	10
0695 79	Adaptor with smoked flap lockable by special tool	■	1
0695 81	Adaptor for RJ socket ensuring IP 44 waterproofness cable already connected	■	1
0919 45	Locking tool (used for changing vandal-proof screws)	■	1

Bold Cat.Nos are products normally available with Legrand (India) Stockists. Cat.Nos that are not bold - delivery within 4 - 8 weeks from the date of order. Bold packing quantity is our mandatory packing. Orders to be placed by Legrand (India) Stockist in multiples of the same.

Legrand cabling system LCS³ doubler sockets, adaptors and accessories

Cat.Nos	Description	MRP* ₹ / Unit	Pack
---------	-------------	------------------	------

Soliroc adaptor

Used for adapting all functions 2 Mosaic modules

IK 10 - IP 55

0778 80	Adaptor with flap	■	1
0778 81	Adaptor without flap	■	1

Hypra adaptor

0539 49	IP 55 adaptor base	■	5
---------	--------------------	---	---

Cable protection accessories

Plastic material

IP 66/67 guaranteed connection with the pair
Cat.No 0 533 02

IP 55 with no connection for base with blank

Protection for RJ 45 shielded or unshielded cables ensuring a link of category 5

Conform to standards of the IEC 60603-7 series and to standard IEC 61076-3-106 (version 5)

Compatible with products on the market conforming to the standards listed

Plug

0533 00	Integrated PE with sealing ring and clamping blades Tool-free assembly Ability to protect cables of category 5e	■	3
---------	---	---	---

Flush-mounting base

0533 01	Locking base Supplied with RJ 45 female/female coupler cat. 5e	■	3
---------	--	---	---

Kit

0533 02	Flush-mounting base + plug	■	3
---------	----------------------------	---	---

Protective flap

0533 03	Fits on base Cat.No 0 533 01	■	3
---------	---------------------------------	---	---

RJ plugs for round cables

Gold-coated contacts 1.2 µm

RJ 11

0517 01	4 contacts, width 9.65 mm	■	50
---------	---------------------------	---	----

RJ 12

0517 02	6 contacts, width 9.65 mm	■	50
---------	---------------------------	---	----

RJ 45 cat. 5e

0517 03	8 contacts, width 11.70 mm	■	50
0517 04	9 contacts, width 11.70 mm	■	50

RJ 45 sleeves

0517 06	Black	■	50
0517 07	White	■	50

Stripping tool

Slits the sheath and releases the conductors by rotation

For twisted pair cables

Does not damage the conductors

Stripper

0332 62	For twisted pair and fibre optic cable	■	1
---------	--	---	---

* MRP - Maximum Retail Price Inclusive of all taxes including GST.

■ Price available on request.

(1) in meters

Legrand cabling system LCS³ doubler sockets, adaptors and accessories

Cat.Nos	Description	MRP* ₹ / Unit	Pack
---------	-------------	------------------	------

Cutting pliers

0327 60	Cut wires cleanly without damaging the copper	■	1
---------	---	---	---

Crimping tool for RJ 45 plugs

Used for crimping plugs

RJ 4/6/8/9 contacts

Ratchet control of crimping

mechanism Able to cut and strip cables

0517 09	Tool with 3 crimping points High resistance steel material	■	1
---------	--	---	---

110 tool

0332 60	110 tool	■	1
0332 61	Replacement blade	■	1

Legrand cabling system LCS³ data and telephone sockets, patch panels, cables

Telephone sockets

RJ 11 and RJ 12 sockets

Equipped with a modular Jack connector with 1/4 turn terminal for fast connection Tap-off possible

5723 00	White - RJ 11, 4 contacts 1 module	■	10
-	Aluminium - RJ 11, 4 contacts - 1 module	■	10
5728 00	Magnesium - RJ 11, 4 contacts - 1 module	■	10
5723 13	White - RJ 11, 4 contacts - 2 modules	■	10
5728 13	Magnesium - RJ 11, 4 contacts - 2 modules	■	10
5723 12	White - RJ 12, 6 contacts - 2 modules	■	10
5728 12	Magnesium - RJ 12, 6 contacts - 2 modules	■	10

ISDN socket

Self-stripping 1/4 turn terminals for fast connection. Tap-off possible

-	White - 8 contacts, 2.5 mm 2 earth terminal	■	10
---	--	---	----

Single master - 2 modules

With IDC connection

Conform to British Telecom

5723 10	White	■	10
5728 10	Magnesium	■	10

Single secondary - 1 module

With IDC connection

Conform to British Telecom

5723 01	White	■	5
5728 01	Magnesium	■	5

Bold Cat.Nos are products normally available with Legrand (India) Stockists. Cat.Nos that are not bold - delivery within 4 - 8 weeks from the date of order. Bold packing quantity is our mandatory packing. Orders to be placed by Legrand (India) Stockist in multiples of the same.

Legrand cabling system LCS³ data and telephone sockets, patch panels, cables

Cat.Nos	Description	MRP* ₹ / Unit	Pack
---------	-------------	------------------	------

Patch panel telephone 50 ports 110 connect

0335 79	19" panel - 1 U	■	1
---------	-----------------	---	---

Cables for telephone networks cat. 3

PVC sleeve
Colour white
Colour code TIA/EIA

U/UTP - 50 pairs

0328 91	Length 500 m Supplied on reel	■	1
---------	----------------------------------	---	---

U/UTP - 100 pairs

0328 88	Length 500 m Supplied on reel	■	1
---------	----------------------------------	---	---

Panels and units for incoming telephone

Panels assembled - 1 U

Fitted with 4 LCS³ RJ 45 units of 12 ports with fast tool-free connection

0335 31	3-6/4-5 contacts for digital telephone	■	1
0335 30	4-5/7-8 contacts for analogue telephone	■	1

Incoming telephone units for self-assembly panels

Fitted with 12 LCS³ RJ 45 ports with quick tool-free connection

0335 33	3-6/4-5 contacts for digital telephone	■	2
0335 32	4-5/7-8 contacts for analogue telephone	■	2

Audio/video system audio/video sockets

Female HD15 sockets

Used to transmit analogue video streams (VGA, XGA, UXGA depending on graphic card) between a source (computer) and a compatible receiver (video projector, TV, etc)

Arteor - Preterminated sockets - 1 module

Equipped with cord, length 15 cm

5720 97	White	■	1
5725 97	Magnesium	■	1

Arteor - Screw-type female HD15 sockets - 2 modules

5722 82	White	■	1
5727 82	Magnesium	■	1

Arteor - Screw-type female HD15 sockets 2 modules + 3.5 mm Jack

5722 88	White	■	1
5727 88	Magnesium	■	1

Arteor - Solder-type female HD15 sockets 1 module

15 pin

5722 79	White	■	1
5727 79	Magnesium	■	1

* MRP - Maximum Retail Price Inclusive of all taxes including GST.
■ Price available on request.



0335 79



5720 97



5720 96



5722 72

Audio/video system audio/video sockets

Cat.Nos	Description	MRP* ₹ / Unit	Pack
---------	-------------	------------------	------

HDMI type A sockets

Used to transmit high-definition digital audio/video streams between a source (computer, HD-DVD drive, etc) and a compatible receiver (TV, video projector, etc)

Arteor - Preterminated sockets HDMI 1.4 - 1 module

Equipped with cord, length 15 cm

5720 96	White	■	1
5725 96	Magnesium	■	1

Arteor - Screw-type sockets HDMI 1.3 - 2 modules

5722 81	White	■	1
5727 81	Magnesium	■	1

Jack sockets 3.5 mm

3.5 mm Jack connectors can be used to create audio/video links

Arteor - Preterminated sockets - 1 module

Equipped with cord, length 15 cm

5720 91	White	■	1
5725 91	Magnesium	■	1

Arteor - 4 screw-type female 3.5 mm Jack socket - 1 module

5722 74	White	■	1
5727 74	Magnesium	■	1

Arteor - Solder-type female 3.5 mm Jack socket - 1 module

5722 78	White	■	1
---------	-------	---	---

Display port sockets

Used to transmit high-definition digital audio/video streams between a source (laptop, computer, etc) and a compatible receiver (video projector, TV, etc)

Arteor - Preterminated socket - 1 module

Equipped with cord, length 15 cm

5720 90	White	■	1
5725 90	Magnesium	■	1

Arteor - Female 2 RCA socket

Preterminated

Equipped with a 15 cm cord

5720 92	White	■	1
5725 92	Magnesium	■	1

Connection via screw terminals

5722 72	White	■	1
5727 72	Magnesium	■	1

Arteor - Female 3 RCA socket

Preterminated

Equipped with a 15 cm cord

5720 93	White	■	1
5725 93	Magnesium	■	1

Bold Cat.Nos are products normally available with Legrand (India) Stockists. Cat.Nos that are not bold - delivery within 4 - 8 weeks from the date of order. Bold packing quantity is our mandatory packing. Orders to be placed by Legrand (India) Stockist in multiples of the same.

Audio/video system audio/video sockets

Cat.Nos	Description	MRP* ₹ / Unit	Pack
---------	-------------	------------------	------

Connection via screw terminals

5722 73	White	■	1
5727 73	Magnesium	■	1

5727 73

Other audio and video sockets

Female BNC 75 socket - 1 module

5722 76	White	■	1
5727 76	Magnesium	■	1

5722 76

Arteor - Audio sockets

XLR 3-pin - 2 modules

5722 83	White - Fast screw connection female	■	1
5727 83	Magnesium - Fast screw connection female	■	1
5722 77	White - Fast screw connection male	■	1

5722 83

Loudspeakers sockets

Terminal 4 mm²

5722 80	White - 2 modules	■	10
5727 80	Magnesium - 2 modules	■	10
5722 70	White - 1 module	■	10
5727 70	Magnesium - 1 module	■	10

5727 70

100 V Line Volume Attenuators - 2 modules

Used to adjust power and volume of a 100 V loudspeaker line

5722 84	White - 100 V - 25 W	■	1
5727 84	Magnesium - 100 V - 25 W	■	1

5722 84

Audio/video system audio/video patch panels, cords and cables

19" patch panels

0335 98	HD15 19" panel - 12 connectors	■	1
0335 97	HDMI 19" panel - 16 connectors	■	1
0335 96	XLR 19" panel - 16 connectors	■	1
0335 99	SUBD9 19" panel - 12 connectors	■	1

0335 98

0335 96

0335 97

0335 99

Cords

For connecting a socket to a terminal

HD15 cord

0517 23	Length 10 m.	■	1
---------	--------------	---	---

0517 23

HD15 cord + 3.5 mm Jack

0517 22	Length 2 m	■	1
---------	------------	---	---

HDMI 1.4 cord

0517 26*	Length 1.5 m	■	1
0517 27*	Length 5 m	■	1
0517 20*	Length 10 m	■	1

* MRP - Maximum Retail Price Inclusive of all taxes including GST.

■ Price available on request.

* To be introduced shortly.

Audio/video system audio/video patch panels, cords and cables

Cat.Nos	Description	MRP* ₹ / Unit	Pack
---------	-------------	------------------	------

HDMI booster

0779 30	Used to extend an HDMI connection.	■	1
---------	------------------------------------	---	---

XLR cord

0517 24	Length 10 m.	■	1
---------	--------------	---	---



0517 24

9-way SUB-D cord

0517 25	Length 10 m.	■	1
---------	--------------	---	---

Cables

VGA cables

0327 81	Length 20 m	■	1
---------	-------------	---	---

HDMI cables

0327 80	Length 20 m	■	1
---------	-------------	---	---

Legrand cabling system LCS³ fibre optic

Equipped 19" optic drawers

Sliding

0321 61	12 SC duplex multi-mode connectors for 24 fibres	■	1
0321 62	24 LC duplex multi-mode connectors for 48 fibres	■	1
0321 63	24 ST multi-mode connectors for 48 fibres	■	1
0321 64	12 SC duplex single-mode connectors for 24 fibres	■	1
0321 65	24 LC duplex single-mode connectors for 48 fibres	■	1
0321 66	12 SC APC duplex single-mode connectors for 24 fibres	■	1
0321 67	24 LC APC duplex single-mode connectors for 48 fibres	■	1



0321 62

Rotating

0321 71	36 LC duplex multi-mode connectors for 72 fibres	■	1
0321 72	18 SC duplex multi-mode connectors for 36 fibres	■	1
0321 73	36 LC duplex single-mode connectors for 72 fibres	■	1
0321 74	18 SC duplex single-mode connectors for 36 fibres	■	1



0321 72

19" modular optic drawers

Sliding, equipped

0321 02	12 SC duplex multi-mode connectors for 24 fibres	■	1
0321 04	24 LC duplex multi-mode connectors for 48 fibres	■	1
0321 06	12 SC duplex single-mode connectors for 24 fibres	■	1

Sliding, to be equipped with fibre optic blocks

It can accept all fibre optic blocks; 4 blocks maximum

0321 00	Empty drawer	■	1
---------	--------------	---	---



0321 00

Bold Cat.Nos are products normally available with Legrand (India) Stockists. Cat.Nos that are not bold - delivery within 4 - 8 weeks from the date of order. Bold packing quantity is our mandatory packing. Orders to be placed by Legrand (India) Stockist in multiples of the same.

Legrand cabling system LCS³ fibre optic

Cat.Nos	Description	MRP* ₹ / Unit	Pack
---------	-------------	------------------	------

Fibre optic blocks

Singlemode fibre optic blocks (9/125 µm)

0321 17	ST block for 6 single-mode fibre optics	■	1
0321 10	SC duplex block for 6 single-mode fibre optics	■	1
0321 11	SC duplex high density block for 12 single-mode fibre optics	■	1
0321 12	SC APC duplex block for 6 single-mode fibre optics	■	1
0321 13	LC duplex block for 6 single-mode fibre optics	■	1
0321 14	LC duplex block for 12 single-mode fibre optics	■	1
0321 15	LC duplex high density block for 24 single-mode fibre optics	■	1
0321 16	LC APC duplex block for 12 single-mode fibre optics	■	1
0321 33	Single-mode 4 MTP ¹ feedthrough adapter	■	1



0321 15



0321 33

Multimode fibre optic blocks (62.5 and 50/125 µm)

0321 27	ST block for 6 multimode fibre optics	■	1
0321 20	SC duplex block for 6 multimode fibre optics	■	1
0321 21	SC duplex high density block for 12 multimode fibre optics	■	1
0321 23	LC duplex block for 6 multimode fibre optics	■	1
0321 24	LC duplex block for 12 multimode fibre optics	■	1
0321 25	LC duplex high density block for 24 multimode fibre optics	■	1
0321 34	Multimode 4 MTP ¹ feedthrough adapter	■	1



0321 21

Copper block for fibre optic drawer

0321 32	"It clips directly to the optic drawer to be equipped, Cat.No 0321 00 It gives the possibility of mixing fibre optic and copper"	■	1
---------	---	---	---

Accessories for optic drawer to be equipped

Accessory for receipt of a fan-out

0321 28	It's clipped at the back of the drawer It enables the entry of preterminated Cat.Nos	■	1
---------	---	---	---

Blank

0321 29	Blank block	■	1
---------	-------------	---	---

Pigtail cassette

0321 30	Capacity 24 fibre optics	■	1
---------	--------------------------	---	---

Coiling kit

0321 31	1 accessory	■	1
---------	-------------	---	---

Modular 19" panel to be equipped with cassettes

0321 40	Depth 190 mm, height 1 U	■	1
---------	--------------------------	---	---

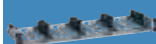

0321 40

* MRP - Maximum Retail Price Inclusive of all taxes including GST.

■ Price available on request.

1: MTP is a registered trademark of US Conec Ltd

Legrand cabling system LCS³ fibre optic

Cat.Nos	Description	MRP* ₹ / Unit	Pack
---------	-------------	------------------	------

Optic drawer cassettes

Fibre optic splice cassette

0321 41	It can accept all modular fibre optic blocks	■	1
---------	--	---	---



0321 41

Copper cassette to be equipped

0337 55	It can accept 6 cat. 5e, cat. 6 and cat. 6 _A connectors	■	1
---------	--	---	---

MTP¹ preterminated cassette (MPO compatible)

Front and rear extraction
High performance cassette, low insertion loss
<0.35 dB

0321 42	Multimode OM4 cassette (50/125 µm) 24 filaments LC OM4 Type A/C	■	1
0321 43	Multimode OM4 cassette (50/125 µm) 12 SC OM4 Type A/C	■	1
0321 44	Single-mode OS2 cassette (9/125 µm) type OS2 24 LC OS2 Type A/C	■	1
0321 45	Single-mode OS2 cassette (9/125 µm) 12 SC OS2 Type A/C	■	1

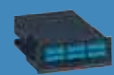

0321 43

Blanking cassette

0337 57	Used to blank the panel	■	1
---------	-------------------------	---	---

Adapters

0321 33	Single-mode 4 MTP ¹ adapter (installation in cassette 0 321 41)	■	1
0321 34	Multi-mode 4 MTP ¹ adapter (installation in cassette 0 321 41)	■	1

Accessories for 19" panel to be equipped with cassettes

0321 46	Rear cable management accessory For installation on panels Cat.No 0 321 40	■	1
0321 47	Cord management kit (guide/support/door)	■	1



0321 46

Pigtails

50/125 µm - OM2 (PC)

Connectors

0322 10	SC 1 m LSZH	■	10
0322 11	LC 1 m LSZH	■	10
0322 12	ST 1 m LSZH	■	10
0322 13	SC 2 m LSZH	■	10
0322 14	LC 2 m LSZH	■	10
0322 15	ST 2 m LSZH	■	10

Bold Cat.Nos are products normally available with Legrand (India) Stockists. Cat.Nos that are not bold - delivery within 4 - 8 weeks from the date of order. Bold packing quantity is our mandatory packing. Orders to be placed by Legrand (India) Stockist in multiples of the same.

Legrand cabling system LCS³ fibre optic

Cat.Nos	Description	MRP* ₹ / Unit	Pack
---------	-------------	------------------	------

50/125 µm - OM3 (PC)

Connectors

0322 20	SC 1 m LSZH	■	10
0322 21	LC 1 m LSZH	■	10
0322 22	ST 1 m LSZH	■	10
0322 23	SC 2 m LSZH	■	10
0322 24	LC 2 m LSZH	■	10

50/125 µm - OM4 (PC)

Connectors

0322 30	SC 1 m LSZH	■	10
0322 31	LC 1 m LSZH	■	10
0322 32	ST 1 m LSZH	■	10
0322 33	SC 2 m LSZH	■	10
0322 34	LC 2 m LSZH	■	10

9/125 µm - OS2 (APC or UPC) - OS1 compatible

Connectors

0322 40	SC-APC OS2 1 m LSZH	■	10
0322 41	SC-UPC OS2 1 m LSZH	■	10
0322 42	LC-APC OS2 1 m LSZH	■	10
0322 43	LC-UPC OS2 1 m LSZH	■	10
0322 44	ST-UPC OS2 1 m LSZH	■	10
0322 45	SC-APC OS2 2 m LSZH	■	10
0322 46	SC-UPC OS2 2 m LSZH	■	10
0322 47	LC-UPC OS2 2 m LSZH	■	10
0322 48	LC-APC OS2 2 m LSZH	■	10
0322 49	ST-UPC OS2 2 m LSZH	■	10

Set of 12 LC pigtails

0326 24	OS2 12 pigtails LC-UPC	■	1
0326 26	OM3 12 pigtails LC-PC	■	1
0326 71	OM4 12 pigtails LC-PC	■	1

Pigtail sleeves

0327 44	40 mm - bag of 50 sheaths	■	1
---------	---------------------------	---	---

Glue-on connectors 50/125 and 62.5/125 µm

0331 27	ST	■	10
0331 47	SC	■	10
0331 00	LC	■	10

Fan-out units

0330 48	6 fibre optic fan-out unit	■	1
0330 49	12 fibre optic fan-out unit	■	1

* MRP - Maximum Retail Price Inclusive of all taxes including GST.

■ Price available on request.

1: MTP is a registered trademark of US Conec Ltd



0322 20

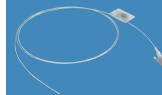

0322 31



0322 70



0322 72



0322 73



0322 75



0322 83

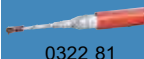

0322 81

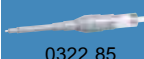

0322 85



0321 50

Legrand cabling system LCS³ fibre optic

Cat.Nos	Description	MRP* ₹ / Unit	Pack
---------	-------------	------------------	------

Tool case for the preparation of the fibre optic for quick-connect connectors

0322 70	It contains the tools required for the preparation of the fibre optic cable, for the completion of a first test to confirm the correct connection of the fibre optic to the connector, and the accessories for easy connection in all situations	■	1
---------	--	---	---

Quick-connect connectors

OM3/OM4 multimode connectors

Set of 12 connectors

0322 71	LC PC 50/125 µm, 900/250 µm	■	1
0322 72	SC PC 50/125 µm, 900/250 µm	■	1

OS2 single-mode connectors

Set of 12 connectors

0322 73	LC UPC 9/125 µm, 900/250 µm	■	1
0322 74	SC UPC 9/125 µm, 900/250 µm	■	1
0322 75	SC APC 9/125 µm, 900/250 µm	■	1

Precision cleaver for the update of the case kit Cat.No 0326 90

0322 80	It's used in conjunction with the kit of the case Cat.No 0 326 90, to cut the fibre optic with precision, and fit the quick-connect connectors, Cat.No 0 322 71 to 0 322 75	■	1
---------	---	---	---

Fibre optic cleaning accessories

0322 83	Ferrule cleaner MPO/MTP1	■	1
0322 81	Ferrule cleaner LC (PC/APC)	■	1
0322 82	Ferrule cleaner SC (PC/APC)	■	1
0322 84	LC replacement cartridge	■	1
0322 85	LC replacement cartridge	■	1

Fibre optic drawers with front facing cord management

0321 50	1 U	■	1
0321 52	2 U	■	1
0321 53	4 U	■	1
0321 51	UHD Panel to be equipped cassette without rear management 1 U	■	1

Very high density cassettes

Multimode OM4 cassette (50/125 µm)

For OM4 type 50/125 µm multimode installations

0321 54	MPO cassette 12 LC OM4 Type A/C	■	1
---------	---------------------------------	---	---

Bold Cat.Nos are products normally available with Legrand (India) Stockists. Cat.Nos that are not bold - delivery within 4 - 8 weeks from the date of order. Bold packing quantity is our mandatory packing. Orders to be placed by Legrand (India) Stockist in multiples of the same.

Legrand cabling system LCS³ fibre optic

Cat.Nos	Description	MRP* ₹ / Unit	Pack
---------	-------------	------------------	------

OS2 cassette (9/125 µm)

For OS2 type 9/125 µm multimode installations

0321 55	MPO cassette 12 LC OS2 Type A/C	■	1
---------	---------------------------------	---	---

MTP¹ adapters (MPO compatible)

They are clipped directly to the fibre optic drawers, Cat.Nos 0 321 50/51/52/53

0321 56	Multimode 4 MTP1 adapter	■	1
0321 57	Single-mode 4 MTP1 adapter	■	1

LC adapter

It's clipped directly to the fibre optic drawers, Cat.Nos 0 321 50/51/52/53

0321 58	Adapter 12 LC multimode	■	1
---------	-------------------------	---	---

Modular 19" panel to be equipped with cassettes

0321 40	Depth 190 mm, height 1 U	■	1
---------	--------------------------	---	---

High density MTP¹ cassette (MPO compatible)

Fibre optic splice cassette

0321 41	It can accept all modular fibre optic blocks	■	1
---------	--	---	---

Copper cassette to be equipped

0337 55	It can accept 6 cat. 5e, cat. 6 and cat. 6A connectors	■	1
---------	--	---	---

Multimode OM4 cassettes (50/125 µm)

0321 42	MTP ¹ cassette (MPO compatible) 24 LC OM4 Type A/C	■	1
0321 43	MTP ¹ cassette (MPO compatible) 12 SC OM4 Type A/C	■	1

Single-mode OS2 cassettes (9/125 µm)

OS2 type

0321 44	MTP ¹ cassette (MPO compatible) 24 LC OS2 Type A/C	■	1
0321 45	MTP ¹ cassette (MPO compatible) 12 SC OS2 Type A/C	■	1

Blanking cassette

0337 57	Used to blank the panel	■	1
---------	-------------------------	---	---

MTP¹ adapters

It's installed in splice cassettes, Cat.No 0 321 41
It enables MTP¹/MTP¹ feedthrough

0321 33	Single-mode 4 MTP ¹ adapter	■	1
0321 34	Multimode 4 MTP ¹ adapter	■	1

* MRP - Maximum Retail Price Inclusive of all taxes including GST.

■ Price available on request.

1: MTP is a registered trademark of US Conec Ltd

Legrand cabling system LCS³ fibre optic preterminated solution

Cat.Nos	Description	MRP* ₹ / Unit	Pack
---------	-------------	------------------	------

Accessories for 19" panel to be equipped with cassette

0321 46	Rear cable management accessory For installation on panels Cat.No 0 321 40	■	1
0321 47	Cord management kit (guide/support/door)	■	1

High density preterminated fibre optic links

Micro cables OM3 Fan-out - Fan-out

Micro cables with spark gap, output 2 mm

0324 01	6 LC Duplex - 6 LC Duplex Length 10	■	1
0324 02	6 LC Duplex - 6 LC Duplex Length 20 (m)	■	1
0324 03	6 LC Duplex - 6 LC Duplex Length 30 (m)	■	1
0324 04	6 LC Duplex - 6 LC Duplex Length 40 (m)	■	1
0324 05	6 LC Duplex - 6 LC Duplex Length 50 (m)	■	1
0324 11	12 LC Duplex - 12 LC Duplex Length 10 (m)	■	1
0324 12	12 LC Duplex - 12 LC Duplex Length 20 (m)	■	1
0324 13	12 LC Duplex - 12 LC Duplex Length 30 (m)	■	1
0324 14	12 LC Duplex - 12 LC Duplex Length 40 (m)	■	1
0324 15	12 LC Duplex - 12 LC Duplex Length 50 (m)	■	1

Micro cables OS2 Fan-out - Fan-out

Micro cables with spark gap, output 2 mm

0324 21	6 LC Duplex - 6 LC Duplex Length 10 (m)	■	1
0324 22	6 LC Duplex - 6 LC Duplex Length 20 (m)	■	1
0324 23	6 LC Duplex - 6 LC Duplex Length 30 (m)	■	1
0324 24	6 LC Duplex - 6 LC Duplex Length 40 (m)	■	1
0324 25	6 LC Duplex - 6 LC Duplex Length 50 (m)	■	1
0324 31	12 LC Duplex - 12 LC Duplex Length 10 (m)	■	1
0324 32	12 LC Duplex - 12 LC Duplex Length 20 (m)	■	1
0324 33	12 LC Duplex - 12 LC Duplex Length 30 (m)	■	1
0324 34	12 LC Duplex - 12 LC Duplex Length 40 (m)	■	1
0324 35	12 LC Duplex - 12 LC Duplex Length 50 (m)	■	1

Bold Cat.Nos are products normally available with Legrand (India) Stockists. Cat.Nos that are not bold - delivery within 4 - 8 weeks from the date of order. Bold packing quantity is our mandatory packing. Orders to be placed by Legrand (India) Stockist in multiples of the same.

Legrand cabling system LCS³ cables

Cat.Nos	Description	MRP* ₹ / Unit	Pack
---------	-------------	------------------	------

Micro cables OM3 MTP1

0324 41	12 fibre optics - MTP ¹ -MTP ¹ Length 10 (m)	■	1
0324 42	12 fibre optics - MTP ¹ -MTP ¹ Length 20 (m)	■	1
0324 43	12 fibre optics - MTP ¹ -MTP ¹ Length 30 (m)	■	1
0324 44	12 fibre optics - MTP ¹ -MTP ¹ Length 40 (m)	■	1
0324 45	12 fibre optics - MTP ¹ -MTP ¹ Length 50 (m)	■	1

Micro cables OS2 MTP1

0324 51	12 fibre optics - MTP ¹ -MTP ¹ Length 10 (m)	■	1
0324 52	12 fibre optics - MTP ¹ -MTP ¹ Length 20 (m)	■	1
0324 53	12 fibre optics - MTP ¹ -MTP ¹ Length 30 (m)	■	1
0324 54	12 fibre optics - MTP ¹ -MTP ¹ Length 40 (m)	■	1
0324 55	12 fibre optics - MTP ¹ -MTP ¹ Length 50 (m)	■	1

OM 4 multimode fibre optic cables (50/125 µm)

"Bend insensitive"

For multimode installations 50/125 µm, type OM 4

Aqua sheaths

Suitable for 10 Giga Ethernet networks

Loose tube

0325 43	Indoor/outdoor (glass strands) 4 fibres - 2000 m	■	2000
0325 44	Indoor/outdoor (glass strands) 8 fibres - 2000 m	■	2000
0325 45	Indoor/outdoor (glass strands) 12 fibres - 2000 m	■	2000
0325 46	Outdoor, corrugated steel tape 4 fibres - 2000 m	■	2000
0325 47	Outdoor, corrugated steel tape 8 fibres - 2000 m	■	2000
0325 48	Outdoor, corrugated steel tape 12 fibres - 2000 m	■	2000

Tight structure 900 µm

0326 65	Indoor/outdoor (glass strands) 6 fibres - 500 m	■	2000
0326 66	Indoor/outdoor (glass strands) 6 fibres - 1000 m	■	2000
0326 67	Indoor/outdoor (glass strands) 12 fibres - 1000 m	■	2000
0326 68	Indoor/outdoor (glass strands) 24 fibres - 1000 m	■	2000

OS 2 single-mode fibre optic cables (9/125 µm) - (OS1 compatible)

For single-mode installations 9/125 µm,

type OS 2

Yellow or black sheaths for outdoor,
rodent guard...

Loose tube

0325 02	Indoor/outdoor (glass strands) 4 fibres	■	2000
0325 03	Indoor/outdoor (glass strands) 8 fibres	■	2000
0325 23	Outdoor, corrugated steel tape 4 fibres	■	2000

* MRP - Maximum Retail Price Inclusive of all taxes including GST.

■ Price available on request.

1: MTP is a registered trademark of US Conec Ltd

Legrand cabling system LCS³ cables

Cat.Nos	Description	MRP* ₹ / Unit	Pack
---------	-------------	------------------	------

Loose tube

0325 24	Outdoor, corrugated steel tape 8 fibres	■	2000
0325 25	Outdoor, corrugated steel tape 24 fibres	■	2000
0325 12	Indoor/outdoor (glass strands) 6 fibres	■	2000
0325 13	Outdoor, corrugated steel tape 6 fibres	■	2000
0325 14	Indoor/outdoor (glass strands) 12 fibres	■	2000
0325 15	Outdoor, corrugated steel tape 12 fibres	■	2000
0325 51	Indoor/outdoor (glass strands) 24 fibres	■	2000

Tight structure 900 µm

0325 50	Indoor/outdoor (glass strands) 12 fibres	■	2000
---------	---	---	------

OM 3 multimode fibre optic cables (50/125 µm)

"Bend insensitive"

For multimode installations 50/125 µm, type OM 3

Aqua sheaths

Suitable for 10 Giga Ethernet networks

Loose tube

0325 53	Indoor/outdoor (glass strands) 24 fibres	■	2000
0325 37	Indoor/outdoor (glass strands) 4 fibres	■	2000
0325 38	Indoor/outdoor (glass strands) 8 fibres	■	2000
0325 39	Indoor/outdoor (glass strands) 12 fibres	■	2000
0325 40	Outdoor, corrugated steel tape 8 fibres	■	2000
0325 41	Outdoor, corrugated steel tape 12 fibres	■	2000
0325 42	Outdoor, corrugated steel tape 24 fibres	■	2000

Tight structure 900 µm

0325 10	Indoor/outdoor (glass strands) 6 fibres	■	2000
0325 11	Indoor/outdoor (glass strands) 12 fibres	■	2000
0325 52	Indoor/outdoor (glass strands) 24 fibres	■	2000

OM 2 multimode fibre optic cables (50/125 µm)

For 50/125 µm multimode installations (OM 2)

Orange jacket or black for outdoor, corrugated

Loose tube

0325 04	Indoor/outdoor (universal) 6 fibres	■	2000
0325 05	Outdoor, corrugated steel tape 6 fibres	■	2000
0325 06	Indoor/outdoor (universal) 12 fibres	■	2000
0325 07	Outdoor, corrugated steel tape 12 fibres	■	2000

Bold Cat.Nos are products normally available with Legrand (India) Stockists. Cat.Nos that are not bold - delivery within 4 - 8 weeks from the date of order. Bold packing quantity is our mandatory packing. Orders to be placed by Legrand (India) Stockist in multiples of the same.

Legrand cabling system LCS³ fibre optic

Cat.Nos	Description	MRP* ₹ / Unit	Pack
900 µm Tight buffer			
0325 55	Indoor/outdoor (universal) 4 fibres	■	2000
0325 08	Indoor/outdoor (universal) 6 fibres	■	2000
0325 09	Indoor/outdoor (universal) 12 fibres	■	2000

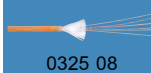

0325 08

Legrand cabling system LCS³ patch cords

OS 1/OS 2 (UPC) single-mode optical cords

SC/SC duplex cords

0326 00	Length: 1 m	■	3
0326 01	Length: 2 m	■	3
0326 02	Length: 3 m	■	3

SC/LC duplex cords

0326 03	Length: 1 m	■	3
0326 04	Length: 2 m	■	3
0326 05	Length: 3 m	■	3

LC/LC duplex cords

0326 28	Length: 0.5 m	■	3
0326 06	Length: 1 m	■	3
0326 07	Length: 2 m	■	3
0326 08	Length: 3 m	■	3
0326 29	Length: 5 m	■	3



0326 07

LC/LC Uniboot duplex cords

Reversible polarity

0326 86	Length: 1 m	■	3
0326 87	Length: 2 m	■	3
0326 88	Length: 3 m	■	3
0326 89	Length: 5 m	■	3
0326 92	Length: 10 m	■	3

OM 4 multimode fibre optic cords (50/125 µm)

SC/SC duplex cords

0326 30	Length: 1 m	■	3
0326 31	Length: 2 m	■	3
0326 32	Length: 3 m	■	3

LC/LC duplex cords

0326 33	Length: 0.5 m	■	3
0326 34	Length: 1 m	■	3
0326 35	Length: 2 m	■	3
0326 36	Length: 3 m	■	3
0326 37	Length: 5 m	■	3

LC/LC Uniboot duplex cords

Reversible polarity

0326 95	Length: 1 m	■	3
0326 96	Length: 2 m	■	3
0326 97	Length: 3 m	■	3
0326 98	Length: 5 m	■	3
0326 99	Length: 10 m	■	3

* MRP - Maximum Retail Price Inclusive of all taxes including GST.

■ Price available on request.

1: MTP is a registered trademark of US Conec Ltd

Legrand cabling system LCS³ fibre optic preterminated solution

Cat.Nos	Description	MRP* ₹ / Unit	Pack
OM 3 multimode fibre optic cords (50/125 µm)			
SC/SC duplex cords			
0326 09	Length: 1 m	■	3
0326 10	Length: 2 m	■	3
0326 11	Length: 3 m	■	3



0326 13

SC/LC duplex cords

0326 12	Length: 1 m	■	3
0326 13	Length: 2 m	■	3
0326 14	Length: 3 m	■	3

LC/LC duplex cords

0326 15	Length: 1 m	■	3
0326 16	Length: 2 m	■	3
0326 17	Length: 3 m	■	3

OM 2 multimode fibre optic cords (50/125 µm)

ST/ST duplex cords

0330 80	Length: 1 m	■	3
0330 81	Length: 2 m	■	3
0330 82	Length: 3 m	■	3

SC/SC duplex cords

0330 69	Length: 1 m	■	3
0330 70	Length: 2 m	■	3
0330 71	Length: 3 m	■	3

ST/SC duplex cords

0330 72	Length: 2 m	■	3
0330 73	Length: 3 m	■	3

LC/LC duplex cords

0330 61	Length: 2 m	■	3
---------	-------------	---	---

SC/LC duplex cords

0330 75	Length: 1 m	■	3
0330 63	Length: 2 m	■	3
0330 76	Length: 3 m	■	3

LC/ST duplex cords

0330 65	Length: 2 m	■	3
---------	-------------	---	---

Fibre optic feedthrough sockets

2 x ST fibre optic feedthrough socket

Bayonet mount (STII compatible)

0786 16	White	■	1
---------	-------	---	---

2 x SC fibre optic feedthrough socket

"Push-pull" connection

0786 17	White	■	1
---------	-------	---	---

2 x LC fibre optic feedthrough socket

"Push-pull" connection

0786 18	White	■	1
---------	-------	---	---

Bold Cat.Nos are products normally available with Legrand (India) Stockists. Cat.Nos that are not bold - delivery within 4 - 8 weeks from the date of order. Bold packing quantity is our mandatory packing. Orders to be placed by Legrand (India) Stockist in multiples of the same.

KIT VIDEO

with memory

OPEN THE DOORS TO SAFETY!

NEW

Bring home the promise of security for every home with Legrand's new standalone video door phone kit with memory.

FLEXIBLE but SIMPLE

Open the #DoorwayToSecurity and live the advantage.



Scan to know more about the product.



KIT VIDEO

with memory

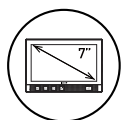

7" LCD screen with the resolution 1024*600

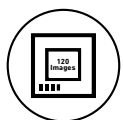

Built-in memory for 120 images



External SD card support



2MP Camera

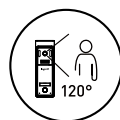

120° camera angle

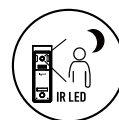

Colour night vision

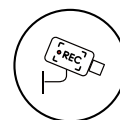

Snap/video recording

Manage One Entrance

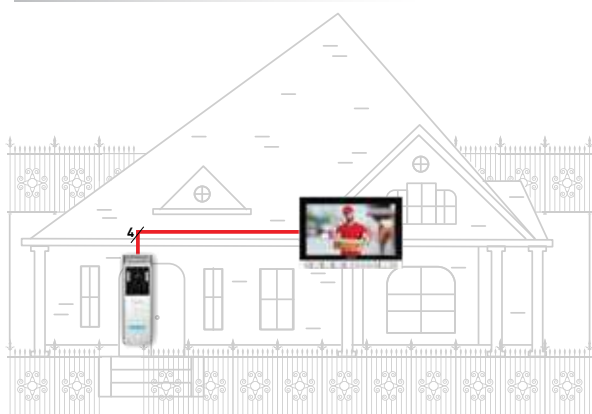

INSTALL 1 VIDEO KIT

Indoor Monitor 7" Push Buttons

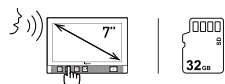

Built-in/Expandable memory

Manage Two Entrance

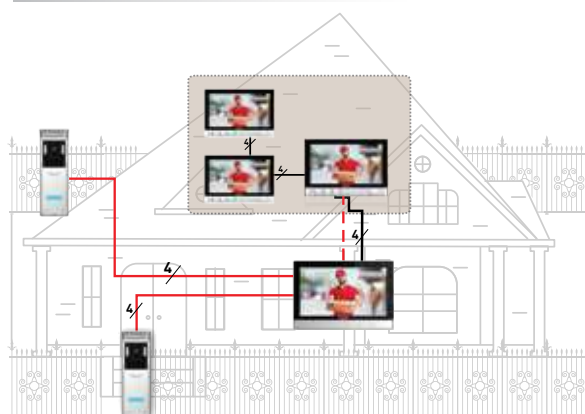

INSTALL 1 VIDEO KIT+ 1 ADDITIONAL ENTRANCE PANEL +3 ADDITIONAL INDOOR MONITORS

----- Add and mix up to 4 Indoor Monitors.

Indoor Monitor 7" Touch Buttons



Intercom



LIGHTING MANAGEMENT SOLUTIONS

INTRODUCING SMART RANGE OF STANDALONE SENSORS TO PUT A STOP TO ENERGY WASTE



048953
PIR DALI dimming



048954
PIR On/Off
presence sensor



048806
Dual Technology

FEATURES



Dali Dimming
with on/off



Configuration
By App



Adjustable
Time delay



Day Light
harvesting



Occupancy/ Vacancy



Sensitivity
adjustment



Scan to know more about
the product.

movement detectors

Cat.Nos	Description	MRP* ₹ / Unit	Pack
---------	-------------	------------------	------

Movement detectors for lighting control

IP 20-IP 55 movement detector with 180- 360° detection angle. For 2000 Watt incadescent, 500 VA LED, 1000 VA flurosent



0488 06

0488 99	PIR ceiling dectector sensor	5480	01/10
0488 06	Dual tech ceiling switch sensor 360°	11752	01/10
0488 07	PIR ceiling switch movement sensor 360°	12018	01/10
0488 17	PIR switch sensor corridor	13416	01/10
0488 04	PIR switch sensor 2 outputs	13652	01/10
0489 33	PIR wall switch sensor 270°	25830	01/10
0489 32	PIR ceiling mounted for warehouse	22308	01/10
0489 53	PIR ceiling mounted with DALI Dimming	18110	01/10
0489 54	PIR celing mounted presence sensor 360°	15596	01/10
0489 59	PIR high bay sensor	25002	01/10
0488 75	Surface mount box	942	01/10
0882 40	Configuration gateway	26916	01/10



0489 53

video door entry systems

Cat.Nos	Description	MRP* ₹ / Unit	Pack
---------	-------------	------------------	------

Door entry kits with memory

3695 90	Door entry kit 7" physical buttons	14000	01/10
3695 91	Door entry kit 7" capacitive buttons	14450	01/10
3695 92	Indoor unit 7" physical buttons	8960	01/10
3695 93	Indoor unit 7" capacitive buttons	9520	01/10
3695 98	Entrance panel for door entry kit 7"	6720	01/20
3695 89	Power adapter for door phone kit	900	01/50

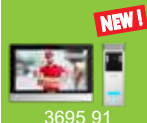

3695 91

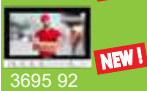

3695 92



3695 93



3695 89

Colour image digital video door entry system kit

3695 80	Basic video kit 7" handsfree	17452	1
3695 70	Basic video kit 7" handset	18452	1
3695 60	Basic video kit 4.3" handsfree	16012	1
3695 50	Basic video kit 4.3" handset	17108	1
3695 00	Basic audio kit handset	8880	1
3695 85	Basic video additional IU 7" handsfree	10224	1
3695 75	Basic video additional IU 7" handset	11622	1
3695 65	Basic video additional IU 4.3" handsfree	9186	1
3695 55	Basic video additional IU 4.3" handset	10240	1
3695 05	Basic audio additional handset	5072	1
3695 96	Basic additional video EP	7290	1
3695 95	Basic additional audio EP	4284	1
3695 97	Basic EP angle bracket	932	1



3695 80

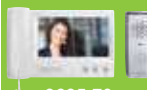

3695 70



3695 60

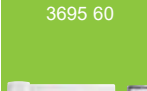

3695 50

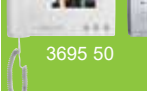

3695 00



3695 85



3695 75



3695 65



3695 55



3695 05



3695 96



3695 95

3695 97

* MRP - Maximum Retail Price Inclusive of all taxes including GST.
Red Cat.Nos - new products

Bold Cat.Nos are products normally available with Legrand (India) Stockists. Cat.Nos that are not bold - delivery within 4 - 8 weeks from the date of order. Bold packing quantity is our mandatory packing. Orders to be placed by Legrand (India) Stockist in multiples of the same.



VIDEO DOOR ENTRY SYSTEM

IP SYSTEM FOR THE BEST PERFORMANCE

The ideal solution for large multiple-dwelling projects, able to guarantee high performance, long distances and high video signal quality.



Guard station



Entrance panel



Video indoor unit



Home + Security
The best App
for a safe home.



Scan to know more about the product.

CLASSE 300EOS

THE SMART VISION OF THE HOME.

Classe 300EOS is the new 2 wires / Wi-Fi handsfree connected video internal unit with built-in Amazon Alexa voice assistant. Using the Home + Security App, in addition to video door entry calls, it is also possible to manage the devices of the Legrand connected security solutions, creating a simple and fast Smart security system.

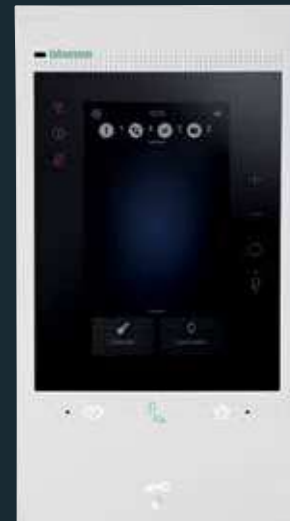

Home + Security
The best App
for a safe home.



Scan to know more about
the product.

P17 TEMPRA PRO

ALWAYS ENSURING
CONTINUITY OF SERVICE

By updating its IP44 and IP 66/67 range of industrial sockets, Legrand is meeting the expectations of professional users. New benefits in terms of safety, implementation, design & ergonomics guarantee the longevity of this family of products, which has already proven itself over time.



IP44

SOCKETS FOR INTERNAL AND EXTERNAL USE, PROTECTED AGAINST PROJECTIONS OF WATER (BUT NOT EXPOSED TO DIRECT JETS)



Straight plugs



Mobile sockets



Panel mounting sockets

A TRANSFORMED RANGE
WHICH HARMONISES WITH
THE LEGRAND INDUSTRIAL
SOCKETS RANGE

- From 16 to 32 A
- 2 P+ E / 3 P+E / 3 P+N+E
- From 100 to 500 VA
- 50/60 Hz
- Screw connection



Scan to know more about
the product.



AIRPORTS, DATA CENTRES,
HOTELS, ETC. P17 TEMPRA
PRO IS IDEAL FOR ALL MAJOR
PROJECTS

IP66/67/69*

WEATHERPROOF SOCKETS THAT
CAN WITHSTAND TEMPORARY
IMMERSION (RAIN, FLOODS, ETC)



Surface mounting
sockets



Straight plugs



Mobile sockets



Panel mounting
sockets



Surface mounting
sockets

- From 16 to 125 A
- 2 P+ E / 3 P+E / 3 P+N+E
- From 100 to 500 VA
- 50/60 Hz
- Screw connection

* On 63 and 125 A plugs and mobile sockets

P17 TEMPRA PRO

ENSURING EASE OF USE AND SAFETY

The new P17 Tempra Pro range has been subject to extensive research in terms of design and safety in order to make life safer and easier for the user. Good product gripping, compact dimensions for use in tight spaces, easier handling, etc. Compliance with standards, anti-corrosion treated materials and components, etc. A comprehensive set of solutions which comply with the standards.

AN INNOVATIVE DESIGN THAT COMPLIES WITH STANDARDS IEC 60309-1 AND 2 AND RESPECTS THE ENVIRONMENT

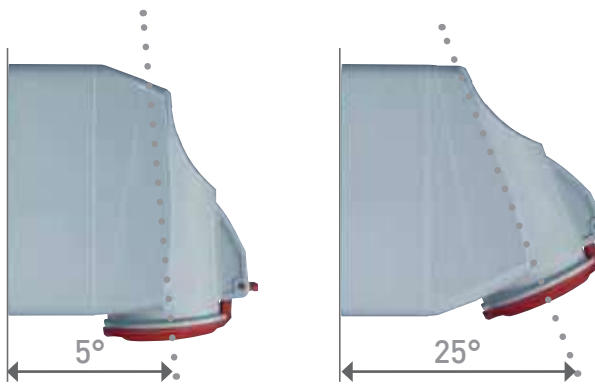

1 2 MOUNTING POSITIONS

To solve the problem of limited space, the surface mounting sockets offer 2 different mounting positions (5° or 25°) which allow users to adapt to the space available without changing the box.



2 CABLE GRIP

Captive cable grip with anti-vibration system holds the cable in place permanently. The 63 and 125 A products are also equipped with a locking screw.



3 EASE OF HANDLING

Gripping areas on the body of the mobile products and the cable grip.

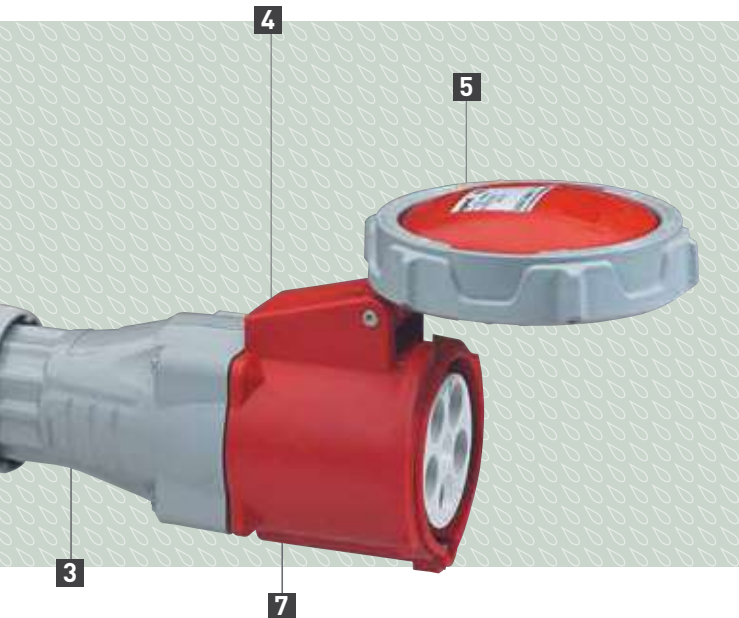

SAFETY & THE ENVIRONMENT

SAFETY

Connection terminals compliant with standards IEC 60 309 1 & 2

Production sites certified according to ISO 14001 and ISO 9001

Very high resistance to chemical products. Plugs and sockets made of polyamide 6

Anti-corrosion treated screws, stainless steel springs for the socket covers

Resistant to temperatures of -25°C to +40°C

ENVIRONMENT

Halogen-free recyclable materials (silicone, PVC) for IP 44 products

Grouped packaging in boxes

PEP products (Eco Passport)



4 OPENING LEVER

For easier connection / disconnection. Cover held open on panel sockets and surface mounting sockets.



5 POSITION MARKING

Information engraved on the ring cover of IP66/67 products means the user can check quickly whether it is in the open or closed position. Marking on cover and flap for easy identification.



6 RIVETED METAL SHAFT

For 63 and 125 A products the riveted metal shaft ensures more strength. The notched locking ring facilitates the locking / unlocking operations.



7 WEATHERPROOF SEALING

For panel mounting sockets.

P17 Tempra Pro IP 44 - LV 16 and 32 A - sockets and plugs

Cat.Nos	Description	MRP* ₹ / Unit	Pack
---------	-------------	------------------	------

Surface mounting sockets

5551 54	200/250 V~, 16 A 2P+E	808	10
5551 58	380/415 V~, 16 A 3P+E	996	10
5551 59	380/415 V~, 16 A 3P+N+E	1054	10
5552 54	200/250 V~, 32 A 2P+E	1008	5
5552 58	380/415 V~, 32 A 3P+E	1262	10
5552 59	380/415 V~, 32 A 3P+N+E	1338	10

Panel mounting sockets inclined outlet

5551 84	200/250 V~, 16 A 2P+E	500	10
5551 88	380/415 V~, 16 A 3P+E	736	10
5551 89	380/415 V~, 16 A 3P+N+E	776	10
5552 84	200/250 V~, 32 A 2P+E	770	10
5552 88	380/415 V~, 32 A 3P+E	972	10
5552 89	380/415 V~, 32 A 3P+N+E	1032	10

Mobile sockets

5551 04	200/250 V~, 16 A 2P+E	652	10
5551 08	380/415 V~, 16 A 3P+E	726	10
5551 09	380/415 V~, 16 A 3P+N+E	770	10
5552 14	200/250 V~, 32 A 2P+E	864	10
5552 18	380/415 V~, 32 A 3P+E	1038	10
5552 19	380/415 V~, 32 A 3P+N+E	1098	10

Straight plugs

5551 24	200/250 V~, 16 A 2P+E	462	10
5551 28	380/415 V~, 16 A 3P+E	566	10
5551 29	380/415 V~, 16 A 3P+N+E	596	10
5552 34	200/250 V~, 32 A 2P+E	696	10
5552 38	380/415 V~, 32 A 3P+E	794	10
5552 39	380/415 V~, 32 A 3P+N+E	842	10

P17 Tempra - domestic pin configuration 16 A - 250 VA

Flush-mounting boxes

0577 21	For 2 panel mounting sockets With single fixing centres 70 x 70 mm - 16 A	4612	3
0577 22	For 1 panel mounting socket With single fixing centres 70 x 70 mm - 16 or 32 A (32 A to be fixed horizontally)	2768	3

* MRP - Maximum Retail Price Inclusive of all taxes including GST.

P17 Tempra Pro IP 66/67 LV 16 and 32 A

Cat.Nos	Polarity	MRP* ₹ / Unit	Pack
---------	----------	------------------	------

Surface mounting sockets

5553 54	200/250 V~, 16 A 2P+E	1350	5
5553 58	380/415 V~, 16 A 3P+E	1502	5
5553 59	380/415 V~, 16 A 3P+N+E	1634	5
5554 54	200/250 V~, 32 A 2P+E	1600	5
5554 55	200/250 V~, 32 A 3P+E	2764	5
5554 59	380/415 V~, 32 A 3P+N+E	2996	5

Panel mounting sockets

5553 84	200/250 V~, 16 A 2P+E	988	5
5553 88	380/415 V~, 16 A 3P+E	1050	5
5553 89	380/415 V~, 16 A 3P+N+E	1116	5
5554 84	200/250 V~, 32 A 2P+E	1254	5
5554 88	380/415 V~, 32 A 3P+E	1436	5
5554 89	380/415 V~, 32 A 3P+N+E	1524	5

Mobile sockets

5553 04	200/250 V~, 16 A 2P+E	1208	5
5553 08	380/415 V~, 16 A 3P+E	1502	5
5553 09	380/415 V~, 16 A 3P+N+E	1594	5
5554 14	200/250 V~, 32 A 2P+E	1658	5
5554 18	380/415 V~, 32 A 3P+E	1772	5
5554 19	380/415 V~, 32 A 3P+N+E	1882	5

Straight plugs

5553 24	200/250 V~, 16 A 2P+E	1050	5
5553 28	380/415 V~, 16 A 3P+E	1152	5
5553 29	380/415 V~, 16 A 3P+N+E	1224	5
5554 34	200/250 V~, 32 A 2P+E	1422	5
5554 38	380/415 V~, 32 A 3P+E	1494	5
5554 39	380/415 V~, 32 A 3P+N+E	1584	5

P17 Tempra Pro IP 66/67 LV 32 A for refrigerated containers

Combined unit, plug and mobile socket for refrigerated containers

6571 06	Combined unit with interlocked switched socket - Double mechanical interlock - Cable glands are not supplied	21316	1
---------	--	-------	---

Bold Cat.Nos are products normally available with Legrand (India) Stockists. Cat.Nos that are not bold - delivery within 4 - 8 weeks from the date of order. Bold packing quantity is our mandatory packing. Orders to be placed by Legrand (India) Stockist in multiples of the same.



5552 58



5551 88



5551 08



5551 28



0577 22



5553 28



6571 06

P17 Tempra Pro IP 66/67 LV 32 A for refrigerated containers

Cat.Nos	Polarity	MRP* ₹ / Unit	Pack
---------	----------	------------------	------

Combined unit, plug and mobile socket for refrigerated containers

5554 91	Panel mounting socket	■	5
5554 21	Mobile socket with cable grip Ø12 to 21.5 mm	■	5
5554 41	Straight plug With cable grip Ø12 to 21.5 mm		5

P17 Tempra Pro IP 66/67 - LV 63 and 125 A

Surface mounting sockets

5555 54	200/250 V~, 63 A 2P+E	5580	2
5555 58	380/415 V~, 63 A 3P+E	5832	2
5555 59	380/415 V~, 63 A 3P+N+E	6162	2
5556 58	380/415 V~, 125 A 3P+E	16168	2
5556 59	380/415 V~, 125 A 3P+N+E	17138	2

Panel mounting sockets

5555 84	200/250 V~, 63 A 2P+E	4426	2
5555 88	380/415 V~, 63 A 3P+E	4514	2
5555 89	380/415 V~, 63 A 3P+N+E	4754	2
5556 88	380/415 V~, 125 A 3P+E	12778	1
5556 89	380/415 V~, 125 A 3P+N+E	13662	1

Straight plugs

5555 24	200/250 V~, 63 A 2P+E	3748	2
5555 28	380/415 V~, 63 A 3P+E	3806	2
5555 29	380/415 V~, 63 A 3P+N+E	4174	2
5556 28	380/415 V~, 125 A 3P+E	11336	1
5556 29	380/415 V~, 125 A 3P+N+E	12014	1

Mobile sockets

5555 04	200/250 V~, 63 A 2P+E	4784	2
5555 08	380/415 V~, 63 A 3P+E	4966	2
5555 09	380/415 V~, 63 A 3P+N+E	5272	2
5556 08	380/415 V~, 125 A 3P+E	16500	1
5556 09	380/415 V~, 125 A 3P+N+E	17488	1

Plugs and sockets

Cat.Nos	Polarity	MRP* ₹ / Unit	Pack
---------	----------	------------------	------

P17 combined unit to be equipped

Bases with mechanical super-compact sockets

0573 00	16 A, 2P+E IP 44 Interlock	5636	1
0573 02	16 A, 3P+N+E IP 44 Interlock	6220	1
0573 20	16 A, 2P+E IP 55 Interlock	6322	1
0573 22	16 A, 3P+N+E IP 55 Interlock	7114	1
0577 23	Mounting plate for 2 super-compact mechanical interlock sockets	3166	1

Bases for 125 x 220 mm face plates

Example of combined unit configuration

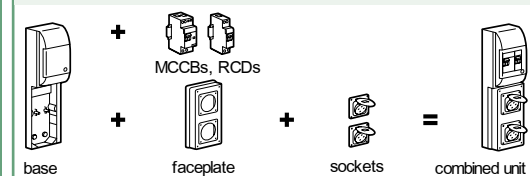

0577 10	Surface mounting box - upto 2 sockets	1318	2
0589 38	Surface mounting box with 5 module dinrail - upto 2 sockets	3684	1
0577 05	Surface mounting box with 12 module dinrail - upto 4 sockets	8138	1
0577 06	Surface mounting box with 18 module dinrail - upto 6 sockets	11392	1

Face plates 125 x 220 mm without sockets

0577 12	For 1 x 16 A or 32 - upto A socket	1250	5
0577 13	For 2 x 16 A - upto sockets	1570	5
0577 17	For 1 x 63 A - upto sockets	1440	5
0577 15	Blanking Plate	1060	5

Bases for 125 x 280 mm faceplates

0577 11	Surface mounting box - upto 3 sockets	1372	3
0577 20	Surface mounting box with 5 module dinrail - upto 3 sockets	3952	1
0577 03	Surface mounting box with 12 module dinrail - upto 6 sockets	8436	1
0577 04	Surface mounting box with 18 module dinrail - upto 9 sockets	11734	1

* MRP - Maximum Retail Price Inclusive of all taxes including GST.

Bold Cat.Nos are products normally available with Legrand (India) Stockists. Cat.Nos that are not bold - delivery within 4 - 8 weeks from the date of order. Bold packing quantity is our mandatory packing. Orders to be placed by Legrand (India) Stockist in multiples of the same.

Plugs and sockets

Cat.Nos	Polarity	MRP* ₹ / Unit	Pack
---------	----------	------------------	------

Face plates 125 x 280 mm without sockets

0577 18	For 2 x 16 A and / or 32 A sockets	1962	4
0577 19	For 1 x 16 A or 32 A socket and 1 x 63 A socket	1844	2
0577 14	For 3 x 16 A sockets	2236	4
0577 16	Blanking plate	1246	4

Hypra industrial plugs and sockets

Sockets

Prisinter panel mounting sockets - IP 44, IK 09

0520 02	230 V, 16 A, 2P+E	11474	1/10
0527 02	230 V, 32 A, 2P+E	12512	1/6
0529 03	415 V, 32 A, 3P+E	12764	1/6
0529 04	415 V, 32 A, 3P+N+E	15164	1/6
0536 04	415 V, 63 A, 3P+N+E	48828	1

Panel mounting sockets - inclined IP 44, IK 09

0522 23	415 V, 16 A, 3P+E	1856	5/50
0538 23	415 V, 63 A, 3P+E	6146	1

Mobile sockets - IP 44, IK 09

0522 83	415 V, 16 A, 3P+E	4250	5/50
---------	-------------------	------	------

Plugs

Straight plugs - IP 44, IK 09

0520 42	250 V, 16 A, 2P+E	2016	5/50
0527 42	250 V, 32 A, 2P+E	2488	1/5
0522 43	415 V, 16 A, 3P+E	3318	5/50
0529 43	415 V, 32 A, 3P+E	3328	5/50
0529 44	415 V, 32 A, 3P+N+E	3684	5/15
0538 43	415 V, 63 A, 3P+E	8794	1/5
0538 44	415 V, 63 A, 3P+N+E	11816	1/5

Metra plugs and sockets

Plugs

Ivory

6500 22	240 V, 10 A, 2P+E	218	1/5/100
6500 28	240 V, 20 A, 2P+E	230	1/5/100

Grey

6500 02	240 V, 10 A, 2P+E	218	1/5/100
6500 08	240 V, 20 A, 2P+E	230	1/5/100
6500 10	440 V, 20 A, 3P+E	306	1/5/100
6500 16	440 V, 32 A, 3P+E	574	1/5/100

Sockets

6500 03	240 V, 10 A, 2P+E With blue cap	222	1/5/100
6500 23	240 V, 10 A, 2P+E With ivory cap	222	1/5/100

* MRP - Maximum Retail Price Inclusive of all taxes including GST.

Hypra industrial plugs and sockets

Cat.Nos	Description	MRP* ₹ / Unit	Pack
---------	-------------	------------------	------

Sockets

6500 09	240 V, 20 A, 2P+E With blue cap	254	1/5/100
6500 29	240 V, 20 A, 2P+E With ivory cap	254	1/5/100
6500 11	440 V, 20 A, 3P+E With red cap	342	1/5/100
6500 17	440 V, 32 A, 3P+E With red cap	574	1/5/100

Plugs and sockets

P17 tempra combined units

With interlocked switched sockets and surface mounting box IP 44

0566 01	250 V, 16 A, 2P+E	8464	1
0566 09	250 V, 32 A, 2P+E	10098	1
0566 13	415 V, 32 A, 3P+E	12212	1
0566 14	415 V, 32 A, 3P+N+E	12822	1

With interlocked switched sockets and surface mounting box IP 55

0566 21	250 V, 16 A, 2P+E	9402	1
0566 29	250 V, 32 A, 2P+E	10742	1
0566 33	415 V, 32 A, 3P+E	13616	1
0566 34	415 V, 32 A, 3P+N+E	13864	1

With interlocked switched sockets and surface mounting box IP 44 with DIN rail for 5 module DX³ protection

0566 41	250 V, 16 A, 2P+E	9030	1
0566 49	250 V, 32 A, 2P+E	10984	1
0566 53	415 V, 32 A, 3P+E	12144	1
0566 54	415 V, 32 A, 3P+N+E	12996	1

With interlocked switched sockets and surface mounting box IP 66 with DIN rail for 5 module DX³ protection

0566 61	250 V, 16 A, 2P+E	10116	1
0566 69	250 V, 32 A, 2P+E	11736	1
0566 73	415 V, 32 A, 3P+E	12672	1
0566 74	415 V, 32 A, 3P+N+E	13698	1

With interlocked switched sockets and without surface mounting box IP 55

0572 21	250 V, 16 A, 2P+E	8138	1
0572 29	250 V, 32 A, 2P+E	9202	1
0572 33	415 V, 32 A, 3P+E	10926	1
0572 34	415 V, 32 A, 3P+N+E	11934	1
0572 95	415 V, 63 A, 3P+N+E, IP 66	26042	1
0577 00	Base box for 0572 95	4426	1

P17 tempra combined units

with interlocked switched sockets IP 66

0589 18	380 to 415 V, 50/60 Hz, 63 A, 3P + E with provision for 5 module DX ³ protection	27734	1
0572 99	380 to 415 V, 50/60 Hz, 63 A, 3P+N+E with provision for 5 module DX ³ protection	31252	1

Bold Cat.Nos are products normally available with Legrand (India) Stockists. Cat.Nos that are not bold - delivery within 4 - 8 weeks from the date of order. Bold packing quantity is our mandatory packing. Orders to be placed by Legrand (India) Stockist in multiples of the same.

LEGRAND

A GLOBAL EDIFICE

Legrand is global specialist in electrical and digital building infrastructures. The Group's headquarter is based at Limoges, France. Legrand (India), the pioneer of Miniature Circuit Breakers in India, is the Indian subsidiary of Legrand Group. The Group services the needs of residential, commercial, hospitality and industrial sectors.

- Manufacturing facilities in 90 countries and sale of products in 180 countries.
- World leader in wiring devices and cable management.
- The group designs and manufactures over 100 product families comprising of 3,00,000 products annually, with due emphasis on high performance, simplified installation and user convenience.
- Close to 1/3 of Legrand's capital expenditure is dedicated to the development of new products.
- Every year, Legrand invests around 4.8% of its global turnover on research and development activities involving over 2100 people worldwide.
- More than 100 showrooms around the globe.



Building trust with 38,200 employees



Sharing the legacy of over 6.9 billion euros turnover in the year 2021



Understanding you through 3,00,000 products



Partnering you with more than 4500 active patents

LEGRAND

GROUP VALUES



CUSTOMER
AWARENESS



INNOVATION



RESOURCE
ENHANCEMENT



ETHICAL
BEHAVIOUR



LEGRAND

PRESTIGIOUS PROJECTS

- Some of the prestigious projects we have been proud to associate with.
- The group services the needs of residential, commercial, hospitality and industrial projects.

NORTH

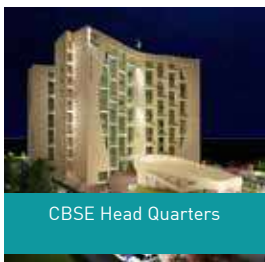
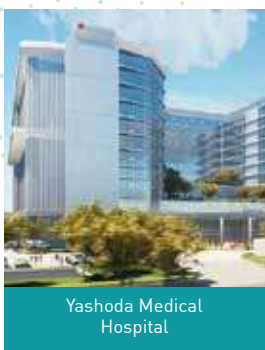

EAST

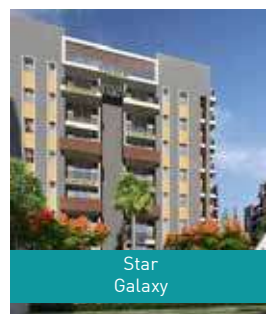

WEST



SOUTH



CENTRAL

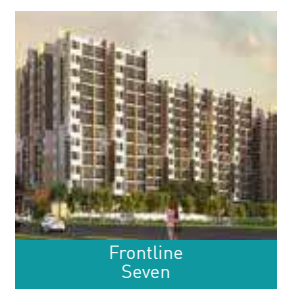
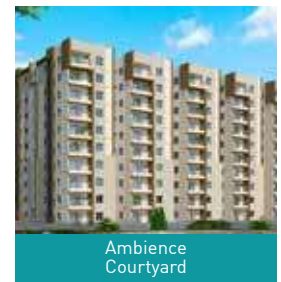

Warranty policy

Legrand warrants to the original purchaser that the Products (excluding any third party products purchased through Legrand, for which no warranties are made) will be free from defects in material and workmanship, under normal use and regular service, and preventative maintenance for a period of 18 months from the date of shipment or 12 months from the date of installation whichever is earlier. Should any failure to conform with this warranty be found during the Warranty Period, you must notify Legrand of your claim within thirty (30) days of discovery, and within the Warranty Period. Your failure to give notice of claims of breach of warranty within the Warranty Period shall be deemed an absolute and unconditional waiver of claims for such defects. Legrand will have no responsibility to honour claims received after the date the applicable Warranty Period expires. The invoice / bill in original must be produced without which warranty claim shall not be entertained.

This warranty does not cover the following:

- Defect caused due to misuse, alteration, faulty installation, faulty electrical systems, negligent maintenance or misapplication of the product.
- Failure of product or components due to any act of nature; lightning strike, floods, hurricanes, tornadoes, etc. beyond the control of human being.
- Legrand does not warrant any third party products or associated hardware or their performance or suitability for use and application. Such items are provided "as-is".

Extended warranty policy is applicable for following products,

1. DX³ & RX³ MCB – 5 years if mounted inside Legrand DB
2. Arteor™, Myrius™, Myrius™ Regular, Mylinc™, Lyncus™, Allzy™, Britzy™ switches (without neon lamp) & Power sockets – 10 years
3. Arteor™, Myrius™, Myrius™ Regular, Mylinc™, Lyncus™, Allzy™, Britzy™ other products – 2 years
4. Arteor IoT & Myrius™ IoT - 2 years

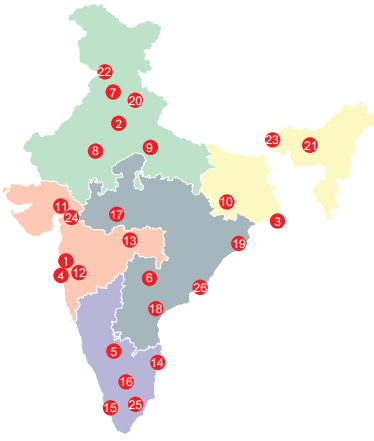

Head offices

- 61 & 62, 6th Floor,
Kalpataru Square, Kondivita Road,
Off Andheri-Kurla Road, Andheri (E),
MUMBAI – 400 059.
Tel.: (022) 3041 6200
Fax : (022) 3041 6201
Website : www.legrand.co.in

Regional sales offices

- B-225, 4th Floor, Okhla Industrial Area, Phase -1,
NEW DELHI - 110020.
Tel.: (011) 3990 2200, 2699 0046,
(011) 2699 0028 / 29 / 30 / 31
Fax : (011) 2699 0047
- Bhakta Towers, 2nd & 3rd Floor,
Plot No. KB 22, Sector-III, Saltlake,
KOLKATA – 700 098.
Tel.: (033) 4021 3535
- C/203, Corporate Avenue, Atul Projects,
Near Mirador Hotel, Chakala,
Andheri - Ghatkopar Link Road,
Andheri – (E), **MUMBAI** – 400 099.
Tel.: (022) 6230 1000
- Ferozes Manor, Situated at 58
Hospital Road, Shivaji Nagar,
BANGALORE – 560 001.
Tel.: (080) 80682 20000
- Prestige Phoenix, 1st Floor,
Next to Lifestyle Building,
Begumpet, Hyderabad,
TELANGANA - 500 016

Branch offices

- Unit No. 203, Tower B Bestech
Business Towers, Sector-66, Mohali,
CHANDIGARH - 160 017.
Tel.: (0172) 5019 008
- Building No-128, Mansarovar Link Road,
Gopalpura Bypass, Mohan Nagar,
Near Ridhi Sidhi Flyover, **JAIPUR** - 302018
Tel.: 0141-2208665
- 209-A, 2nd Floor, Cyber Heights,
Opp. Indira Gandhi Pratishthan,
Vibhuti Khand, Gomti Nagar,
LUCKNOW - 226 010.
Tel.: (0522) 431 9316
- 202 & 203, Sunrise, Forum 100,
Burdwan Compound, Lalpur,
RANCHI - 834 001.
Tel.: (651) 660 5400
- A 101-102, Mondeal Heights,
Besides Novotel Hotel, Sarkhej
Gandhinagar Highway (S G Highway),
AHMEDABAD – 380 015.
Tel.: (079) 6134 0555
- 8th Floor, Pinnacle Park Avenue,
Opp. Law College, Law College Road
Next To German Bakery,
Shivaji Nagar, **PUNE** - 411004.
Tel.: (020) 6729 5601 / 600
- Plot No.95, 2nd Floor, Shreyash
Heights, VIP Road, Ramdaspath,
NAGPUR – 440 010.
Tel.: (0712) 2440 900
- 10 B, Prestige Center Court, Office Block,
Vijaya Forum Mall, #183,N.S.K. Salai,
Vadapalani, **CHENNAI** – 600 026.
Tel.: (044) 6612 2800
- J. B. Manjooran Estate,
Door No. 50/1107 A9, 3rd Floor,
Bye Pass Junction, Edappally,
COCHIN – 682 024.
Tel.: (0484) 6604 700
- 204-205, Megapolis Square,
579, M G Road,
INDORE – 452 001.
Tel.: (0731) 4999 891
- MF-2, Datta's Lords House,
Jammi Chettu Street, Mogalrajapuram,
VIJAYAWADA – 520 010.
Tel.: (0866) 248 2393/6393
- Plot No. 359, Saheed Nagar,
2nd Floor,
BHUBANESWAR – 751 007.
Tel.: (0674) 254 0623
- Unit - 1 & 2, Vijay Park,
Main Chakrata Road,
DEHRADUN- 248 001.
Uttarakhand.
Tel.: (0135) 661 6100
- House No. 97, Ground Floor,
Rajgarh Main Road,
Opp. City Heart Nursing Home,
GUWAHATI – 781 007.

Area offices

- Cabin No. 9, 2nd Floor,
Madhok Trade Centre,
Madhok Complex, Ferozpur Road,
LUDHIANA – 141 001.
Tel.: (0161) 277 0301
- 94, Udhm Singh Sarani,
Ground Floor, Ashrampara,
SILIGURI – 734 001.
Tel.: (353) 264 1067
- A-207, Universal Business
Center, Near Madhuvan Circle,
L.P. Savani Road, Adajan,
SURAT - 395 009.
Tel.: (0261) 263 3861
- Aparna Towers, 1st Floor, 2/3,
Bypass Road,
MADURAI – 625 010.
Telefax : (0452) 230 8414
- 43-9-205, 3rd Floor, Plot No. 10,
Subbalakshmi Nagar,
Opp. More Super Market,
VISAKHAPATNAM – 530 016.
Tel.: (0891) 273 5652 / 2739363
- B-5, 1st Floor, Thirumalai Towers,
723, Avanashi Road,
COIMBATORE – 641 018.
Tel.: (0422) 668 3200
- 515 & 516, Gera Imperium Grand,
Patto centre ,
Panaji **GOA** – 403 001
- 1st Floor, Cordial Bharathi,
Nanthancodu, Thiruvanthapuram,
KERALA- 695 003

Technical assistance from Legrand

Telephonic technical assistance for selection of products, technical information, guidance, wiring diagrams and estimation is now made available to you at each Regional Office. Contact the Technical Officer of Legrand at the following telephone numbers

- New Delhi** : Tel.: (011) 2699 0028, 3990 2200
Kolkata : Tel.: (033) 4021 3535 / 36
Mumbai : Tel.: (022) 6230 1000
Chennai : Tel.: (044) 6612 2800
Hyderabad : Tel.: (040) 4567 1717

For other places, contact the nearest
Regional / Branch / Area offices

customer.care@legrand.co.in



LIVE THE ADVANTAGE