



Light Enlightens Life

ARCHITECTURAL LED LIGHTING

AETHER



AETHER - Indoor Wall Lights

			
<p>Product Code : LWL101-1 Product Features : Indoor Voltage Range : AC 140 - 265V Watts Available : 12 W Colors Available : NWH Body Color : WHITE Body : Alu. Die Cast IP Rating : IP40</p>		<p>Product Code : LWL101-2 Product Features : Indoor Voltage Range : AC 140 - 265V Watts Available : 24 W Colors Available : NWH Body Color : WHITE Body : Alu. Die Cast IP Rating : IP40</p>	
			
<p>Product Code : LWL102-1 Product Features : Indoor Voltage Range : AC 140 - 265V Watts Available : 9 W Colors Available : WH, WW Body Color : WHITE Body : Alu. Die Cast IP Rating : IP40</p>		<p>Product Code : LWL102-2 Product Features : Indoor Voltage Range : AC 140 - 265V Watts Available : 18 W Colors Available : WH, WW Body Color : WHITE Body : Aluminium Die Cast IP Rating : IP40</p>	
			
<p>Product Code : LWL103-1 Product Features : Indoor Voltage Range : AC 140 - 265V Watts Available : 12 W Colors Available : WW Body Color : WHITE Body : Aluminium Die Cast IP Rating : IP40</p>		<p>Product Code : LWL103-2 Product Features : Indoor Voltage Range : AC 140 - 265V Watts Available : 22 W Colors Available : WW Body Color : WHITE Body : Aluminium Die Cast IP Rating : IP40</p>	

AETHER



AETHER - Indoor Wall Lights

			
<p>Product Code : LWL104 Product Features : Indoor Voltage Range : AC 140 - 265V Watts Available : 12 W Colors Available : WW Body Color : WHITE Body : Aluminium Die Cast IP Rating : IP40</p>		<p>Product Code : LWL105 Product Features : Indoor Wall Light Voltage Range : AC 140 - 265V Watts Available : 12 W Colors Available : WW Body Color : WHITE Body : Aluminium Die Cast IP Rating : IP40</p>	
			
<p>Product Code : LWL106 Product Features : Indoor Wall Light Voltage Range : AC 140 - 265V Watts Available : 30 W Colors Available : WW Body Color : WHITE Body : Aluminium Die Cast IP Rating : IP40</p>		<p>Product Code : LWL107 Product Features : Indoor Wall Light Voltage Range : AC 140 - 265V Watts Available : 30 W Colors Available : WW Body Color : WHITE Body : Aluminium Die Cast IP Rating : IP40</p>	
			
<p>Product Code : LWL108 Product Features : Indoor Wall Light Voltage Range : AC 140 - 265V Watts Available : 20 W Colors Available : WW Body Color : WHITE Body : Aluminium Die Cast IP Rating : IP40</p>		<p>Product Code : LWL109R / LWL109L Product Features : Indoor Wall Light Voltage Range : AC 140 - 265V Watts Available : 6 W Colors Available : WH, WW Body Color : WHITE Body : Aluminium Die Cast IP Rating : IP40</p>	

AETHER



AETHER - Indoor Wall Lights

	<p>Product Code : LWL110-1 Product Features : Indoor Wall Light Voltage Range : AC 140 - 265V Watts Available : 7 W Colors Available : WH, WW Body Color : WHITE Body : Glass Body IP Rating : IP40</p>		<p>Product Code : LWL110-2 Product Features : Indoor Wall Light Voltage Range : AC 140 - 265V Watts Available : 14 W Colors Available : WH, WW Body Color : WHITE Body : Glass Body IP Rating : IP40</p>
	<p>Product Code : LWL111-1 Product Features : Indoor Wall Light Voltage Range : AC 140 - 265V Watts Available : 7 W Colors Available : WH, WW Body Color : WHITE Body : Glass Body IP Rating : IP40</p>		<p>Product Code : LWL111-2 Product Features : Indoor Wall Light Voltage Range : AC 140 - 265V Watts Available : 14 W Colors Available : WH, WW Body Color : WHITE Body : Glass Body IP Rating : IP40</p>
	<p>Product Code : LWL112-1 Product Features : Indoor Wall Light Voltage Range : AC 140 - 265V Watts Available : 7 W Colors Available : WH, WW Body Color : WHITE Body : Glass Body IP Rating : IP40</p>		<p>Product Code : LWL112-2 Product Features : Indoor Wall Light Voltage Range : AC 140 - 265V Watts Available : 14 W Colors Available : WH, WW Body Color : WHITE Body : Glass Body IP Rating : IP40</p>

AETHER



AETHER - Indoor Wall Lights

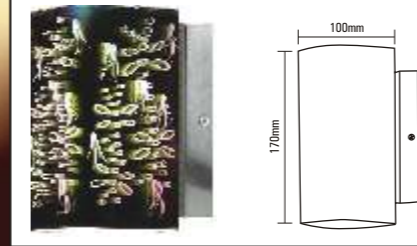

Product Code : LWL113-1
Product Features : Indoor
Voltage Range : AC 140 - 265V
Watts Available : 7 W
Colors Available : WW
Body Color : WHITE
Body : Glass Body
IP Rating : IP40

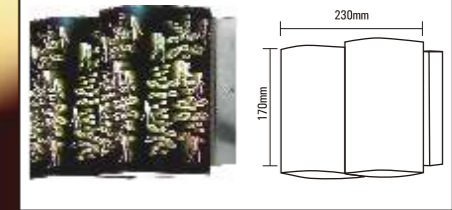

Product Code : LWL113-2
Product Features : Indoor Wall Light
Voltage Range : AC 140 - 265V
Watts Available : 14 W
Colors Available : WH, WW
Body Color : WHITE
Body : Glass Body
IP Rating : IP40

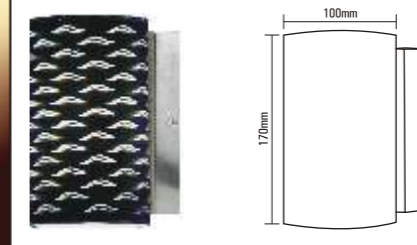

Product Code : LWL114-1
Product Features : Indoor Wall Light
Voltage Range : AC 140 - 265V
Watts Available : 7 W
Colors Available : WH, WW
Body Color : WHITE
Body : Glass Body
IP Rating : IP40

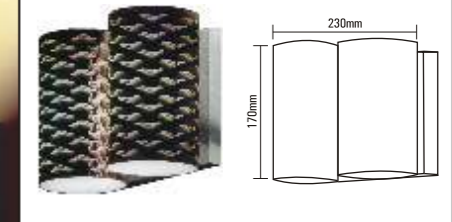

Product Code : LWL114-2
Product Features : Indoor Wall Light
Voltage Range : AC 140 - 265V
Watts Available : 14 W
Colors Available : WH, WW
Body Color : WHITE
Body : Glass Body
IP Rating : IP40

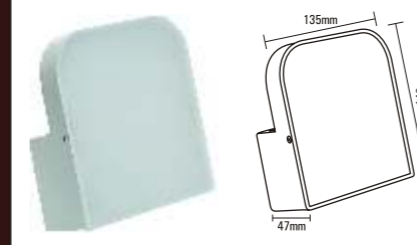

Product Code : LWL115
Product Features : Indoor Wall Light
Voltage Range : AC 140 - 265V
Watts Available : 12 W
Colors Available : WH, WW
Body Color : WHITE
Body : Aluminium Die Cast
IP Rating : IP40

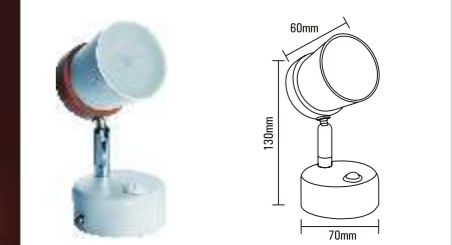

Product Code : LSP06
Product Features : Indoor Wall Light
Voltage Range : AC 140 - 265V
Watts Available : 6 W
Colors Available : WH, WW
Body Color : WHITE
Body : Aluminium Die Cast
IP Rating : IP40

AETHER



AETHER - Indoor Wall Lights

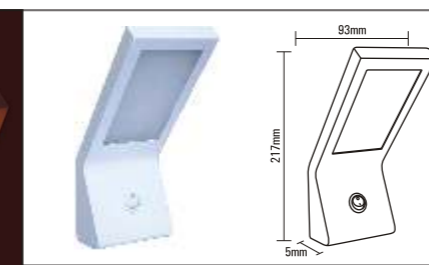

Product Code : LBSL9
Product Features : Indoor Wall Light
Voltage Range : AC 140 - 265V
Watts Available : 9 W
Colors Available : WH, WW
Body Color : WHITE
Body : Aluminium Die Cast
IP Rating : IP40

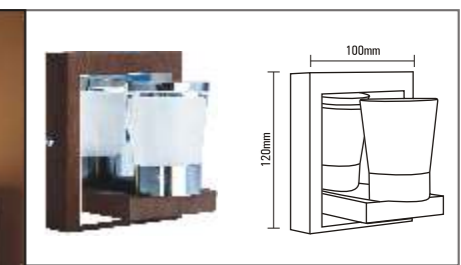

Product Code : LWL117-1
Product Features : Indoor Wall Light
Voltage Range : AC 140 - 265V
Watts Available : 5 W
Colors Available : WH, WW
Body Color : WOODEN
Body : Aluminium Die Cast
IP Rating : IP40

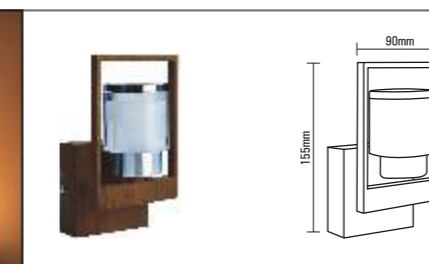

Product Code : LWL118-1
Product Features : Indoor Wall Light
Voltage Range : AC 140 - 265V
Watts Available : 5 W
Colors Available : WH, WW
Body Color : WOODEN
Body : Aluminium Die Cast
IP Rating : IP40

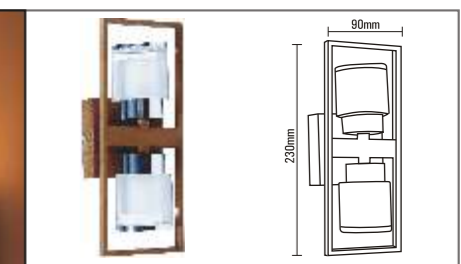

Product Code : LWL118-2
Product Features : Indoor Wall Light
Voltage Range : AC 140 - 265V
Watts Available : 10 W
Colors Available : WH, WW
Body Color : WOODEN
Body : Aluminium Die Cast
IP Rating : IP40

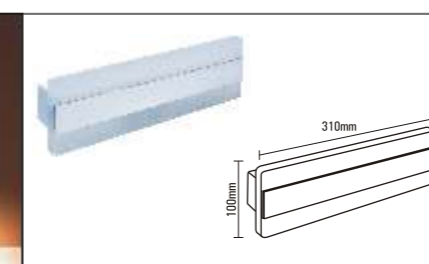

Product Code : LWL119
Product Features : Indoor Wall Light
Voltage Range : AC 140 - 265V
Watts Available : 11 W
Colors Available : WH, WW
Body Color : WHITE
Body : Aluminium Die Cast
IP Rating : IP40

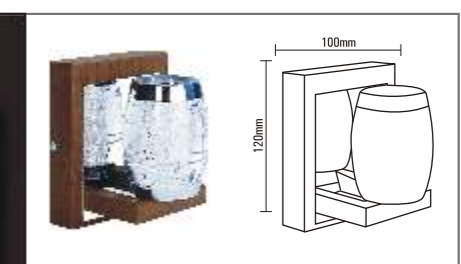

Product Code : LWL120-1
Product Features : Indoor Wall Light
Voltage Range : AC 140 - 265V
Watts Available : 5 W
Colors Available : WH, WW
Body Color : WOODEN
Body : Aluminium Die Cast
IP Rating : IP40

AETHER

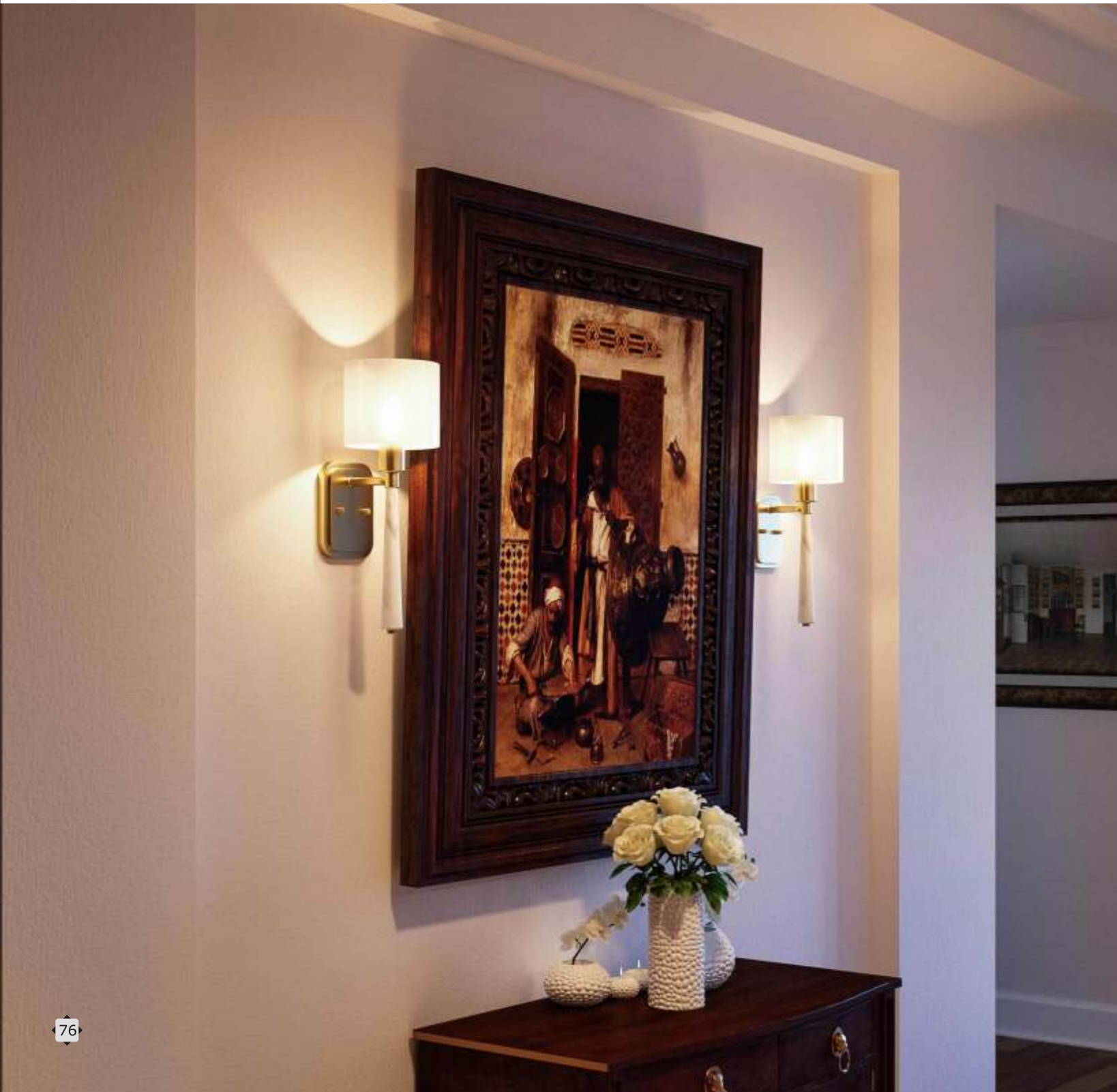

AETHER - Indoor Wall Lights

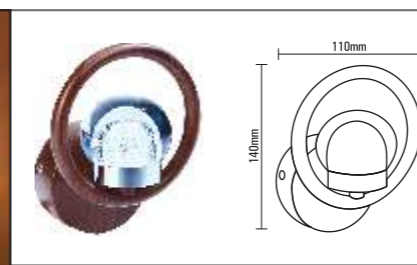

Product Code : LWL121-1
Product Features : Indoor Wall Light
Voltage Range : AC 140 - 265V
Watts Available : 3 W
Colors Available : WW
Body Color : WOODEN
Body : Aluminium Die Cast
IP Rating : IP40

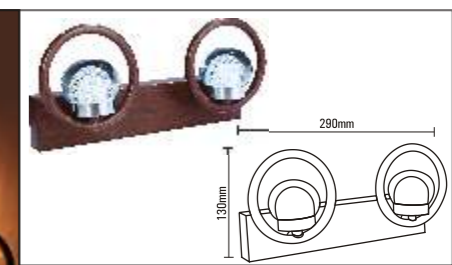

Product Code : LWL121-2
Product Features : Indoor Wall Light
Voltage Range : AC 140 - 265V
Watts Available : 6 W
Colors Available : WW
Body Color : WOODEN
Body : Aluminium Die Cast
IP Rating : IP40

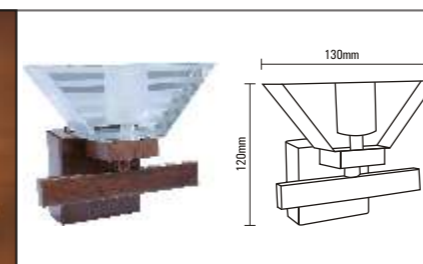

Product Code : LWL122-1
Product Features : Indoor Wall Light
Voltage Range : AC 140 - 265V
Watts Available : 3 W
Colors Available : WW
Body Color : WOODEN
Body : Aluminium Die Cast
IP Rating : IP40

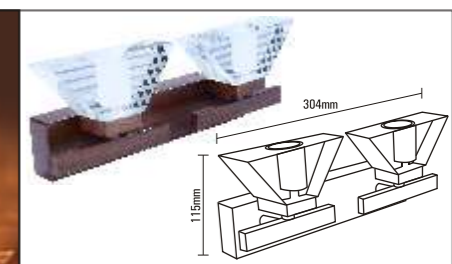

Product Code : LWL122-2
Product Features : Indoor Wall Light
Voltage Range : AC 140 - 265V
Watts Available : 6 W
Colors Available : WW
Body Color : WOODEN
Body : Aluminium Die Cast
IP Rating : IP40

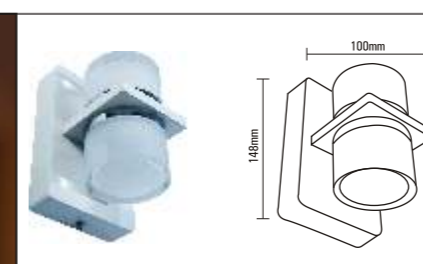

Product Code : LWL125-2
Product Features : Indoor Wall Light
Voltage Range : AC 140 - 265V
Watts Available : 10 W
Colors Available : WW
Body Color : WHITE
Body : Aluminium Die Cast
IP Rating : IP40

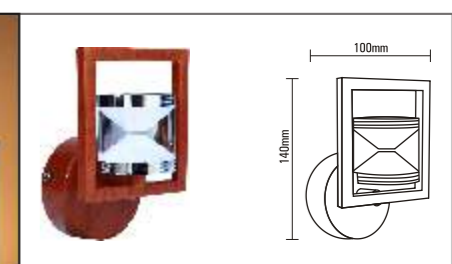

Product Code : LWL126-1
Product Features : Indoor Wall Light
Voltage Range : AC 140 - 265V
Watts Available : 5 W
Colors Available : WW
Body Color : WOODEN
Body : Aluminium Die Cast
IP Rating : IP40

AETHER



AETHER - Indoor Wall Lights

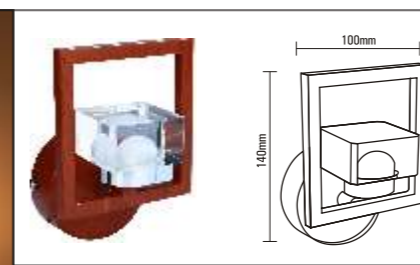

Product Code : LWL127-1
Product Features : Indoor Wall Light
Voltage Range : AC 140 - 265V
Watts Available : 3 W
Colors Available : WW
Body Color : WOODEN
Body : Aluminium Die Cast
IP Rating : IP40

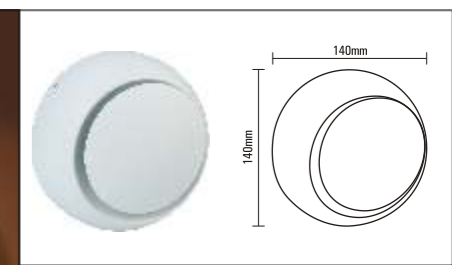

Product Code : LWL128
Product Features : Indoor Wall Light
Voltage Range : AC 140 - 265V
Watts Available : 5 W
Colors Available : WW
Body Color : WHITE
Body : Aluminium Die Cast
IP Rating : IP40

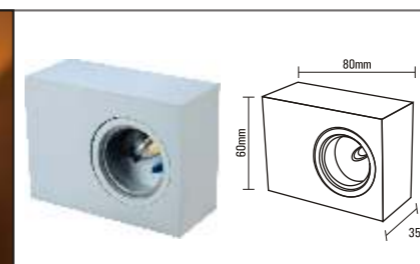

Product Code : LWL116
Product Features : Indoor Wall Light
Voltage Range : AC 140 - 265V
Watts Available : 2 W
Colors Available : WW
Body Color : WHITE
Body : Aluminium Die Cast
IP Rating : IP40

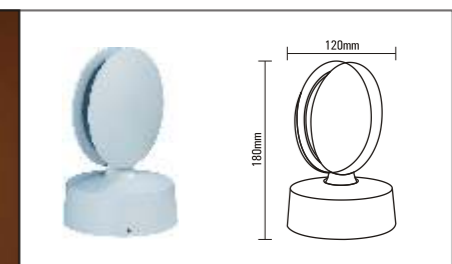
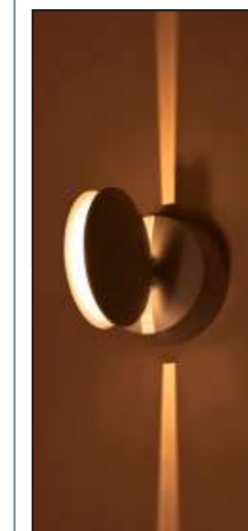

Product Code : LODCL07
Product Features : Indoor Wall Light
Voltage Range : AC 140 - 265V
Watts Available : 7 W
Colors Available : WW
Body Color : WOODEN
Body : Aluminium Die Cast
IP Rating : IP40

PERSONAL LIGHTS

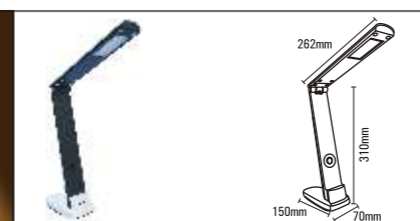

Product Code : LTL05
Product Features : Personal / Table Light
Voltage Range : AC 140 - 265V
Watts Available : 5 W
Colors Available : NWH
Body Color : BLACK & WHITE
Body : ABS Plastic Body
IP Rating : IP40

HELIOS - Mirror Lights

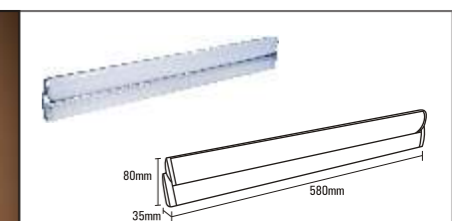

Product Code : LMR13
Product Features : Indoor
Voltage Range : AC 140 - 265V
Watts Available : 12 W
Colors Available : WH, WW
Body Color : GREY
Body : Aluminium Body
IP Rating : IP40

HELIOS



HELIOS - Mirror Lights

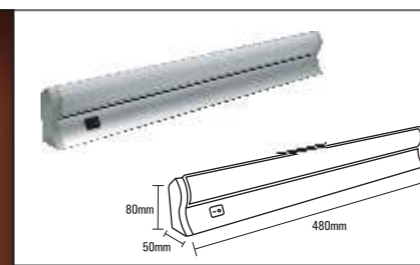

Product Code : LMR9
Product Features : Indoor
Voltage Range : AC 140 - 265V
Watts Available : 11 W
Colors Available : WH, WW
Body Color : GREY
Body : Aluminium Body
IP Rating : IP40

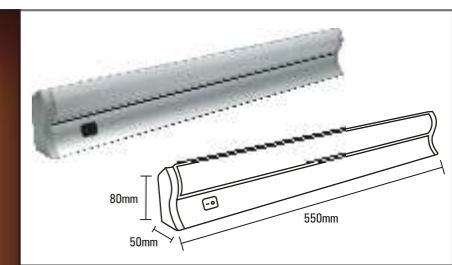

Product Code : LMR12
Product Features : Indoor
Voltage Range : AC 140 - 265V
Watts Available : 13 W
Colors Available : WH, WW
Body Color : GREY
Body : Aluminium Body
IP Rating : IP40

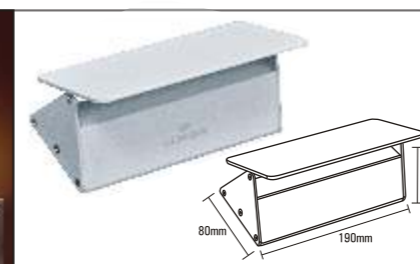

Product Code : LADMR6
Product Features : Indoor - Indirect Light
Voltage Range : AC 140 - 265V
Watts Available : 6 W
Colors Available : WH, WW
Body Color : WHITE
Body : Aluminium Die Cast
IP Rating : IP20

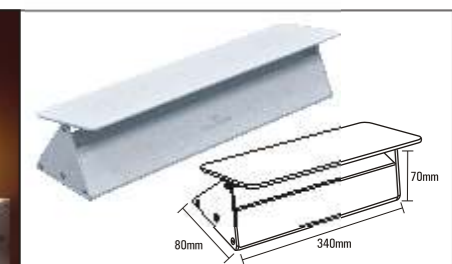

Product Code : LADMR12
Product Features : Indoor - Indirect Light
Voltage Range : AC 140 - 265V
Watts Available : 12 W
Colors Available : WH, WW
Body Color : WHITE
Body : Aluminium Die Cast
IP Rating : IP20

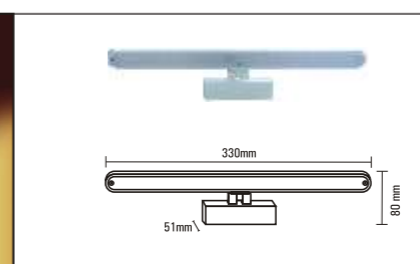

Product Code : LMCL12
Product Features : Indoor
Voltage Range : AC 140 - 265V
Watts Available : 12 W
Colors Available : WH, WW
Body Color : WHITE
Body : Aluminium Die Cast
IP Rating : IP20

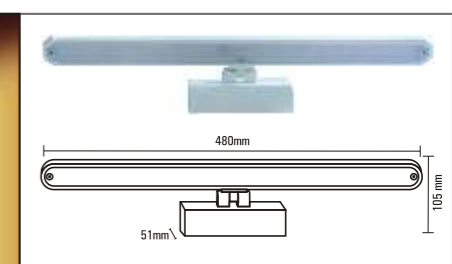
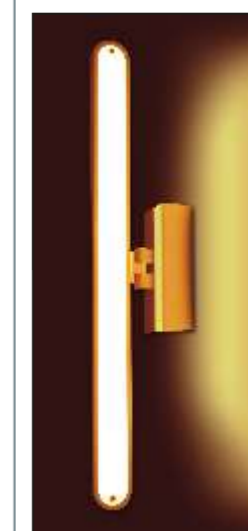

Product Code : LMCL18
Product Features : Indoor
Voltage Range : AC 140 - 265V
Watts Available : 18 W
Colors Available : WH, WW
Body Color : WHITE
Body : Aluminium Die Cast
IP Rating : IP20

HELIOS



HELIOS - Mirror Lights

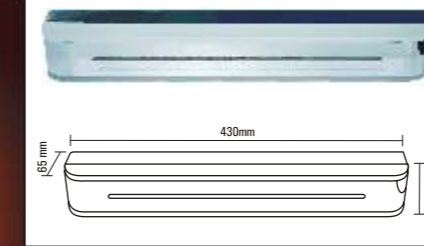

Product Code : LMCL15
Product Features : Indoor
Voltage Range : AC 140 - 265V
Watts Available : 15 W
Colors Available : WH, NW
Body Color : CHROME
Body : Steel & Acrylic
IP Rating : IP20

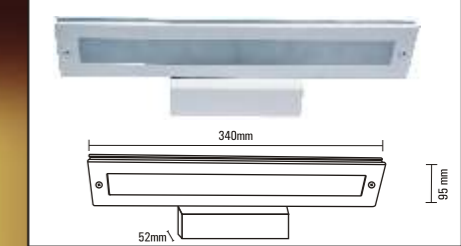

Product Code : LMJL12
Product Features : Indoor
Voltage Range : AC 140 - 265V
Watts Available : 12 W
Colors Available : WH, WW
Body Color : WHITE
Body : Aluminium Die Cast
IP Rating : IP20

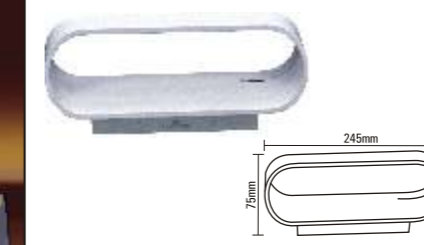

Product Code : LMR6
Product Features : Indoor - Indirect Light
Voltage Range : AC 140 - 265V
Watts Available : 6 W
Colors Available : WH, WW
Body Color : WHITE
Body : Aluminium Die Cast
IP Rating : IP20

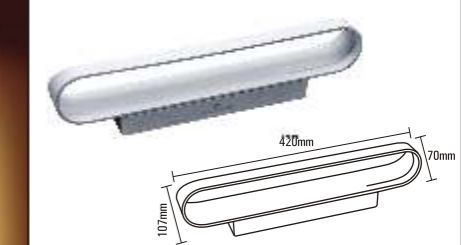

Product Code : LMR12
Product Features : Indoor - Indirect Light
Voltage Range : AC 140 - 265V
Watts Available : 12 W
Colors Available : WH, WW
Body Color : WHITE
Body : Aluminium Die Cast
IP Rating : IP20

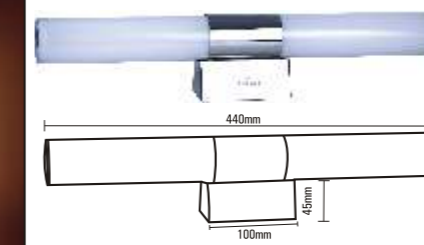

Product Code : LMR10
Product Features : Indoor
Voltage Range : AC 140 - 265V
Watts Available : 10W
Colors Available : WH, WW
Body Color : Chrome
Body Finish : Aluminium Die Cast
IP Rating : IP40

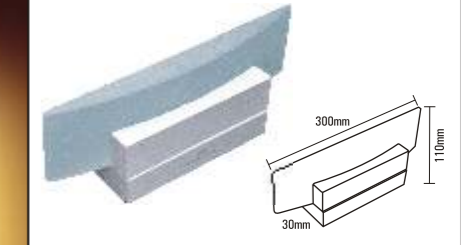

Product Code : LIWL6
Product Features : Indoor
Voltage Range : AC 140 - 265V
Watts Available : 12 W
Colors Available : WH
Body Color : WHITE
Body : Alu. Die Cast with Curved Glass
IP Rating : IP40

PLUTUS



PLUTUS - Outdoor Wall Lights - Up & Down

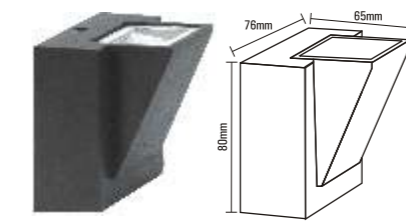

Product Code : LODARCS-3D
Product Features : Outdoor
Voltage Range : AC 140 - 265V
Watts Available : 1 x 3W
Colors Available : WH, WW
Body Color : Dark Grey
Body : Aluminium Die Cast
IP Rating : IP65

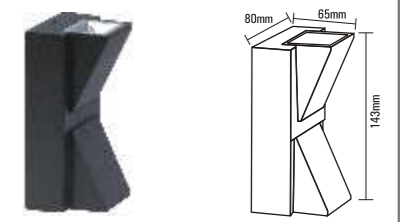

Product Code : LODARCD-6D
Product Features : Outdoor
Voltage Range : AC 140 - 265V
Watts Available : 2 x 3W
Colors Available : WH, WW
Body Color : Dark Grey
Body : Aluminium Die Cast
IP Rating : IP65

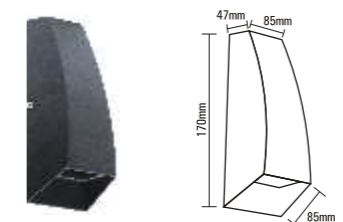

Product Code : LARCUPD-6D
Product Features : Outdoor
Voltage Range : AC 140 - 265V
Watts Available : 2 x 3W
Colors Available : WH, WW
Body Color : Dark Grey
Body : Aluminium Die Cast
IP Rating : IP65

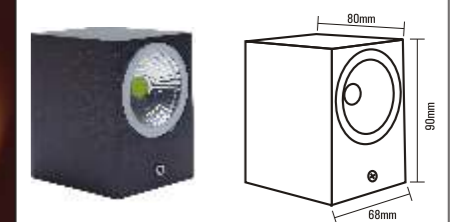

Product Code : LODSQS3D
Product Features : Outdoor
Voltage Range : AC 140 - 265V
Watts Available : 1 x 3W
Colors Available : WH, WW
Body Color : Dark Grey
Body : Aluminium Die Cast
IP Rating : IP65

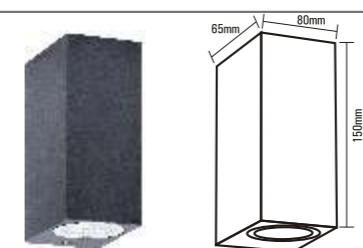

Product Code : LODSQPD10D
Product Features : Outdoor
Voltage Range : AC 140 - 265V
Watts Available : 2 x 3W
Colors Available : WH, WW
Body Color : Dark Grey
Body : Aluminium Die Cast
IP Rating : IP65

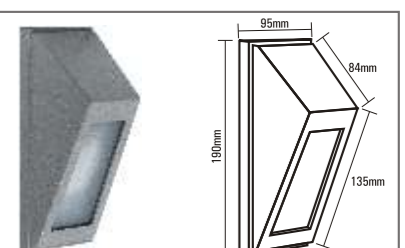

Product Code : LODWD5
Product Features : Outdoor
Voltage Range : AC 140 - 265V
Watts Available : 9W
Colors Available : WH, WW
Body Color : Dark Grey
Body : Aluminium Die Cast
IP Rating : IP65

PLUTUS



PLUTUS - Outdoor Wall Lights - Up & Down



Product Code : LODUPGU10
Product Features : Outdoor
Voltage Range : AC 140 - 265V
Watts Available : 1 x 3W
Colors Available : WH, WW
Body Color : Dark Grey
Body Finish : Aluminium Die Cast
IP Rating : IP65

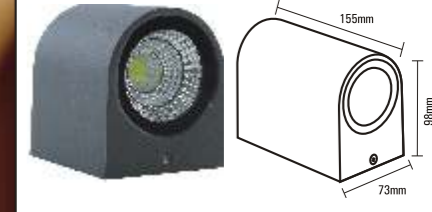

Product Code : LODUPDGU10
Product Features : Outdoor
Voltage Range : AC 140 - 265V
Watts Available : 2 x 3W
Colors Available : WH, WW
Body Color : Dark Grey
Body Finish : Aluminium Die Cast
IP Rating : IP65

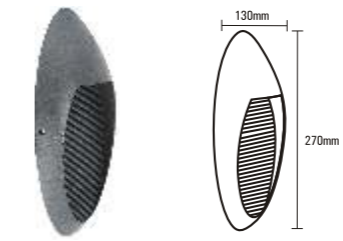

Product Code : LODOV3D
Product Features : Outdoor
Voltage Range : AC 140 - 265V
Watts Available : 3W
Colors Available : WH, WW
Body Color : Dark Grey
Body : Aluminium Die Cast
IP Rating : IP65

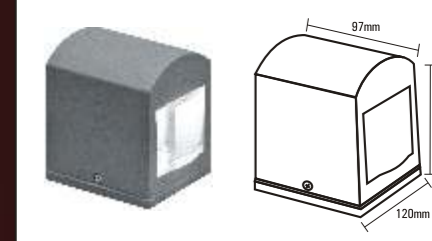

Product Code : LODSG-9 / LODDG-9
Product Features : Outdoor - Single Side / Double Sided Glass
Voltage Range : AC 140 - 265V
Watts Available : 1 x 3W / 2 x 3W
Colors Available : WH, WW
Body Color : Silver Grey
Body : Aluminium Die Cast
IP Rating : IP65

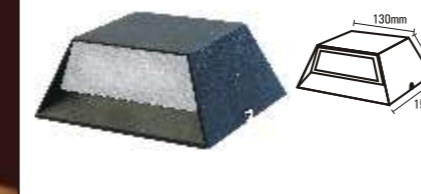

Product Code : LARCS3
Product Features : Outdoor
Voltage Range : AC 140 - 265V
Watts Available : 1 x 3W
Colors Available : WH, WW
Body Color : Dark Grey
Body : Aluminium Die Cast
IP Rating : IP65

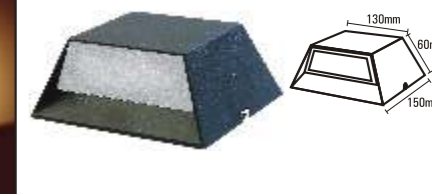

Product Code : LARCD6
Product Features : Outdoor
Voltage Range : AC 140 - 265V
Watts Available : 2 x 3W
Colors Available : WH, WW
Body Color : Dark Grey
Body Finish : Aluminium Die Cast
IP Rating : IP65

PLUTUS

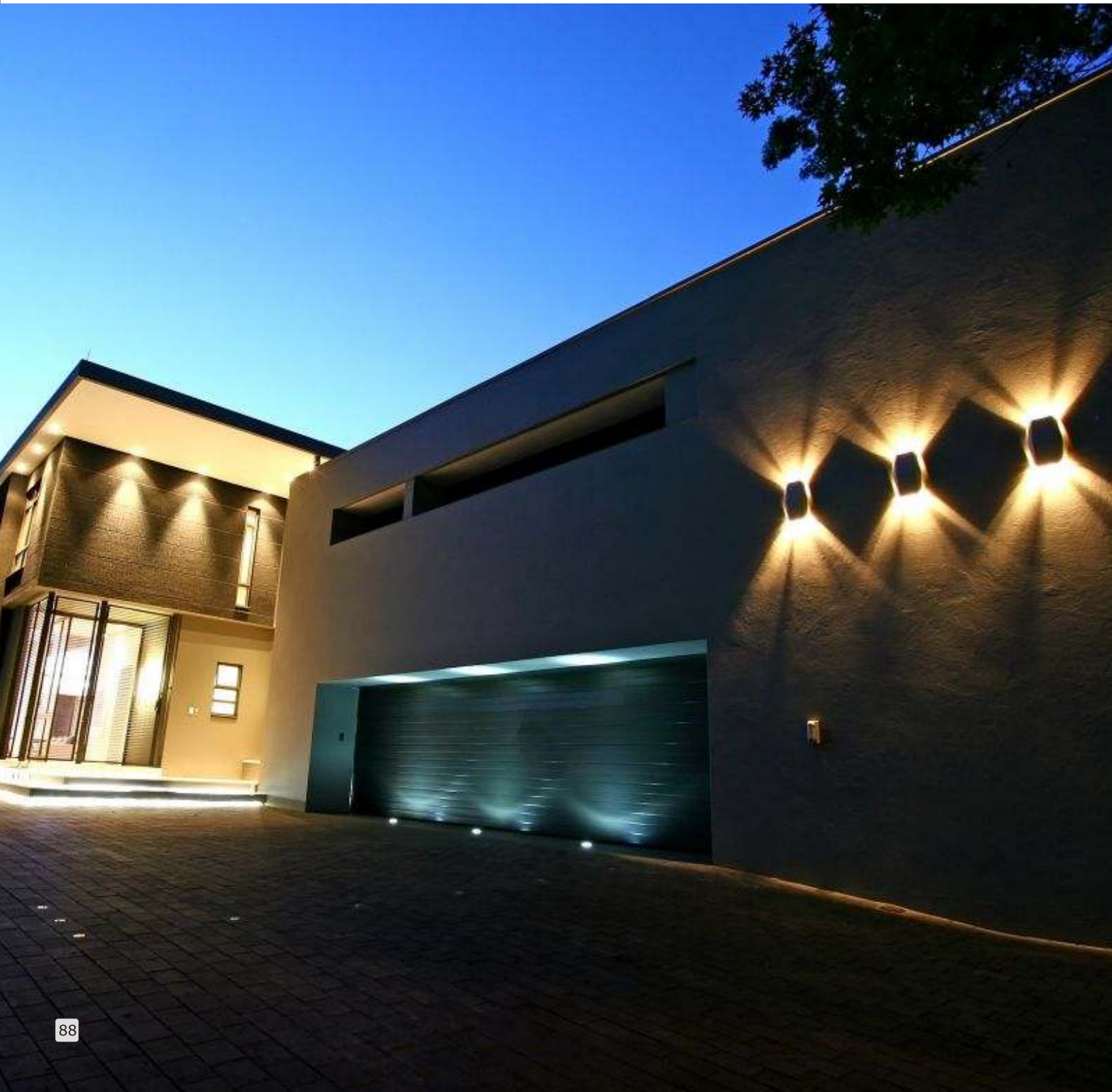

PLUTUS - Outdoor Wall Lights - Up & Down

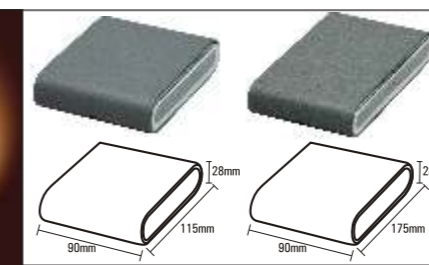

Product Code : LWARC4 LWARC6
Product Features : Outdoor
Voltage Range : AC 140 - 265V
Watts Available : 2 x 3W 2 x 4W
Colors Available : WH, WW
Body Color : Dark Grey
Body : Aluminium Die Cast
IP Rating : IP65

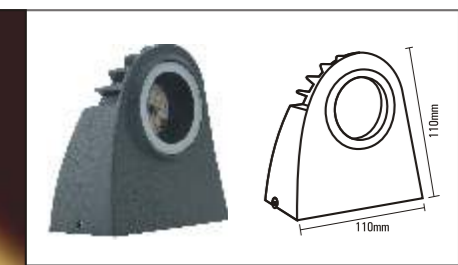

Product Code : LWRCR6
Product Features : Outdoor
Voltage Range : AC 140 - 265V
Watts Available : 5W
Colors Available : WH, WW
Body Color : Dark Grey
Body : Aluminium Die Cast
IP Rating : IP65

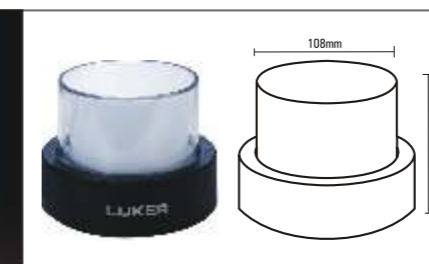

Product Code : LCLA05
Product Features : Outdoor
Voltage Range : AC 140 - 265V
Watts Available : 5W
Colors Available : WH, WW
Body Color : Dark Grey
Body : Aluminium Die Cast
IP Rating : IP65

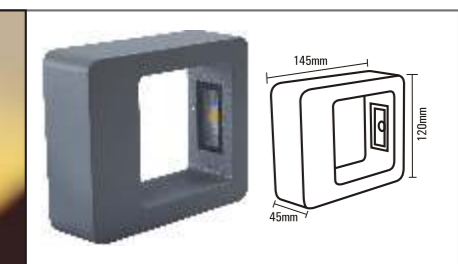

Product Code : LARCS5
Product Features : Outdoor
Voltage Range : AC 140 - 265V
Watts Available : 3W
Colors Available : WH, WW
Body Color : Dark Grey
Body : Aluminium Die Cast
IP Rating : IP65

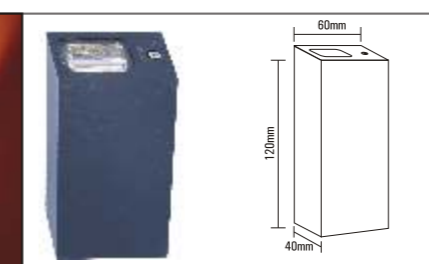

Product Code : LDL06
Product Features : Outdoor
Voltage Range : AC 140 - 265V
Watts Available : 2 x 3W
Colors Available : WH, WW
Body Color : Dark Grey
Body : Aluminium Die Cast
IP Rating : IP65

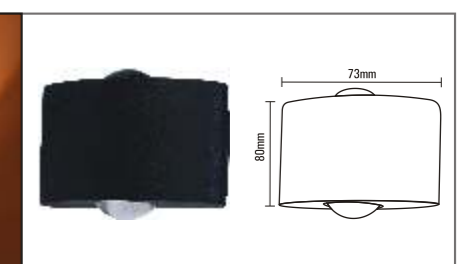

Product Code : LOD428
Product Features : Outdoor
Voltage Range : AC 140 - 265V
Watts Available : 8W
Colors Available : WW
Body Color : Dark Grey
Body : Aluminium Die Cast
IP Rating : IP65

PLUTUS



PLUTUS - Outdoor Wall Lights - Up & Down

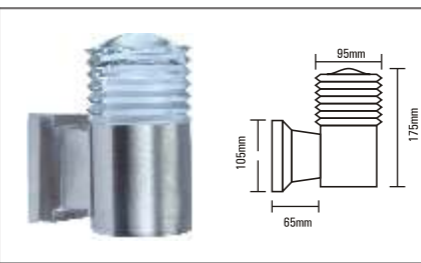

Product Code : LODWS105
Product Features : Outdoor
Voltage Range : AC 140 - 265V
Watts Available : 6 W
Colors Available : WH, WW
Body Color : Silver
Body : Aluminium Die Cast
IP Rating : IP65

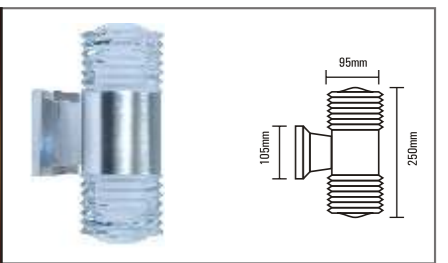

Product Code : LODWS205
Product Features : Outdoor
Voltage Range : AC 140 - 265V
Watts Available : 2 x 6W
Colors Available : WH, WW
Body Color : Silver
Body : Aluminium Die Cast
IP Rating : IP65

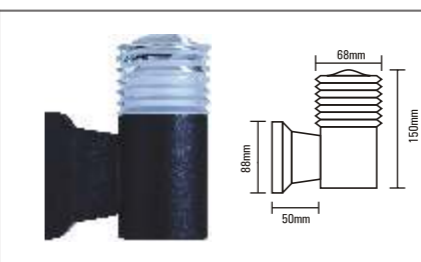

Product Code : LODWS103
Product Features : Outdoor
Voltage Range : AC 140 - 265V
Watts Available : 3W
Colors Available : WH, WW
Body Color : Matt Black
Body : Aluminium Die Cast
IP Rating : IP65

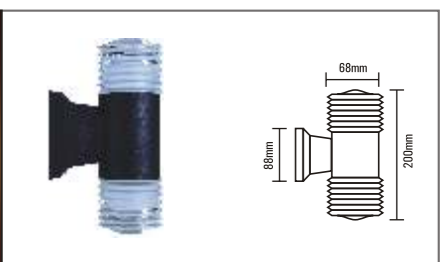

Product Code : LODWS203
Product Features : Outdoor
Voltage Range : AC 140 - 265V
Watts Available : 2 x 3W
Colors Available : WH, WW
Body Color : Matt Black
Body : Aluminium Die Cast
IP Rating : IP65

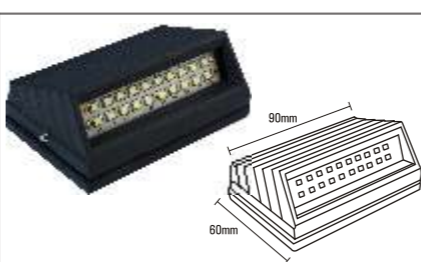

Product Code : LODSR515
Product Features : Outdoor
Voltage Range : AC 140 - 265V
Watts Available : 5 W
Colors Available : WH, WW
Body Color : Dark Grey
Body : Aluminium Die Cast
IP Rating : IP65

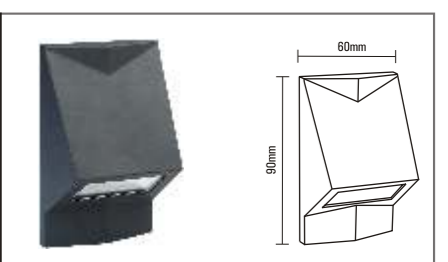

Product Code : LOD919
Product Features : Indoor
Voltage Range : AC 140 - 265V
Watts Available : 9W
Colors Available : WW
Body Color : Dark Grey
Body : Aluminium Die Cast
IP Rating : IP65

PLUTUS





PLUTUS - Outdoor Wall Lights - Up & Down





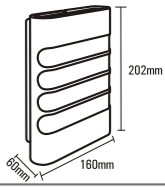

Product Code : LOD544
Product Features : Indoor
Voltage Range : AC 140 - 265V
Watts Available : 5W
Colors Available : WH, WW
Body Color : Dark Grey / White
Body : Aluminium Die Cast
IP Rating : IP65

STYX - Bulkhead Lights





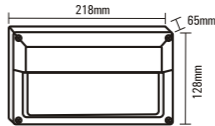

Product Code : LWLEW10
Product Features : Outdoor
Voltage Range : AC 140 - 265V
Watts Available : 10W
Colors Available : WH, WW
Body Color : Dark Grey
Body Finish : Aluminium Die Cast
IP Rating : IP65



STYX - Bulkhead Lights

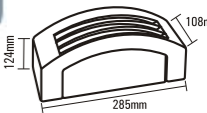

Product Code : LWLES10
Product Features : Outdoor
Voltage Range : AC 140 - 265V
Watts Available : 5W
Colors Available : WH, WW
Body Color : Silver Grey
Body : Aluminium Die Cast
IP Rating : IP65

Product Code : LWLER10
Product Features : Outdoor
Voltage Range : AC 140 - 265V
Watts Available : 10W
Colors Available : WH, WW
Body Color : Silver Grey
Body : Aluminium Die Cast
IP Rating : IP65

Product Code : LODSQG9
Product Features : Outdoor
Voltage Range : AC 140 - 265V
Watts Available : 5W
Colors Available : WH / WW
Body Color : Silver Grey
Body Finish : Aluminium Die Cast
IP Rating : IP65

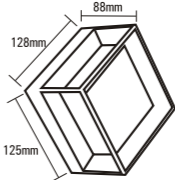
Product Code : LBKOVSL04
Product Features : Outdoor
Voltage Range : AC 140 - 265V
Watts Available : 12W
Colors Available : WH, WW
Body Color : Silver Grey
Body Finish : Aluminium Die Cast
IP Rating : IP65

LBKOVSL12
Product Features : Outdoor
Voltage Range : AC140-265V
Watts Available : 12W
Colors Available : WH, WW
Body Color : White
Body Finish : Plastic
IP Rating : IP65

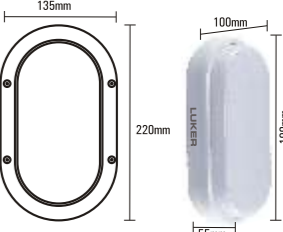
STYX



STYX - Bulkhead Lights

<p>Product Code : LODCLOE-27 Product Features : Outdoor Voltage Range : AC 140 - 265V Watts Available : 18W Colors Available : WH / WW Body Color : Silver Grey Body : Aluminium Die Cast IP Rating : IP65</p>		<p>Product Code : LBKSQSL04 Product Features : Outdoor Voltage Range : AC 140 - 265V Watts Available : 5W Colors Available : WH, WW Body Color : Silver Grey Body Finish : Aluminium Die Cast IP Rating : IP65</p>	
<p>Product Code : LODCLSE-27 Product Features : Outdoor Voltage Range : AC 140 - 265V Watts Available : 18W Colors Available : WH / WW Body Color : Silver Grey Body : Aluminium Die Cast IP Rating : IP65</p>		<p>Product Code : LWSQB10 Product Features : Outdoor Voltage Range : AC 140 - 265V Watts Available : 10W Colors Available : WH, WW Body Color : Dark Grey / Silver Grey Body : Aluminium Die Cast IP Rating : IP65</p>	
<p>Product Code : LODWL-10 Product Features : Outdoor Voltage Range : AC 140 - 265V Watts Available : 10W Colors Available : WW Body Color : Dark Grey Body : Aluminium Die Cast IP Rating : IP65</p>		<p>Product Code : LODWL-11 Product Features : Outdoor Voltage Range : AC 140 - 265V Watts Available : 10W Colors Available : WW Body Color : Dark Grey Body : Aluminium Die Cast IP Rating : IP65</p>	

STYX



STYX - Bulkhead Lights

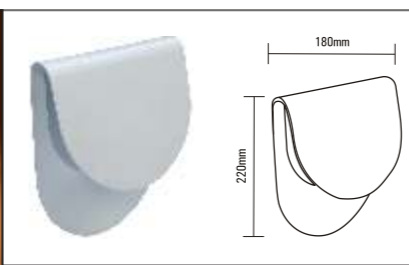

Product Code : LODWL-12
Product Features : Outdoor
Voltage Range : AC 140 - 265V
Watts Available : 10W
Colors Available : WW
Body Color : Dark Grey
Body : Aluminium Die Cast
IP Rating : IP65

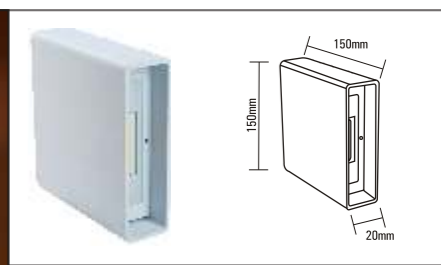

Product Code : LODWS14
Product Features : Outdoor
Voltage Range : AC 140 - 265V
Watts Available : 14W
Colors Available : WW
Body Color : Dark Grey / White
Body Finish : Aluminium Die Cast
IP Rating : IP65

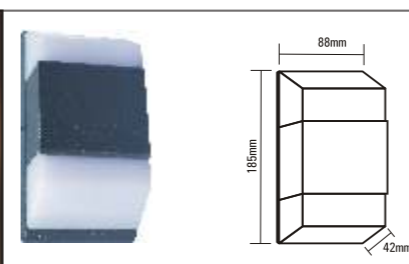

Product Code : LODSR8
Product Features : Outdoor
Voltage Range : AC 140 - 265V
Watts Available : 8W
Colors Available : WH, WW
Body Color : Dark Grey
Body : Aluminium Die Cast
IP Rating : IP65

TRITON - Indoor & Outdoor Footlights & Pathway Lights

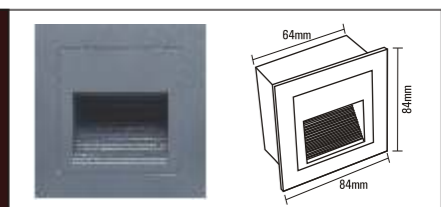

Product Code : LODFTG3 / LODFTW3
Product Features : Outdoor
Voltage Range : AC 140 - 265V
Watts Available : 3W
Colors Available : WH / WW
Body Color : Dark Grey / PK White
Body : Aluminium Die Cast
IP Rating : IP65

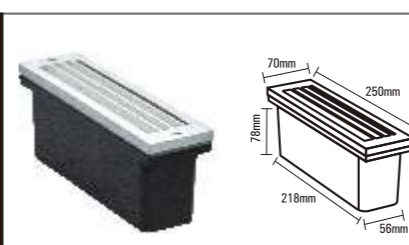

Product Code : LODBLE-27
Product Features : IP65 - Outdoor
Voltage Range : AC 140 - 265V
Watts Available : 6W
Colors Available : WH / WW
Body Color : Silver Grey
Body Finish : Aluminium Powder Coated Body
IP Rating : IP65

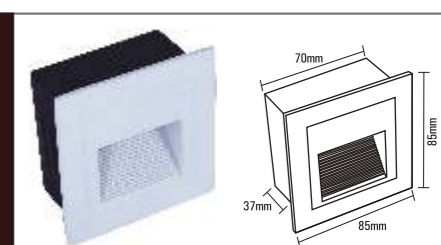
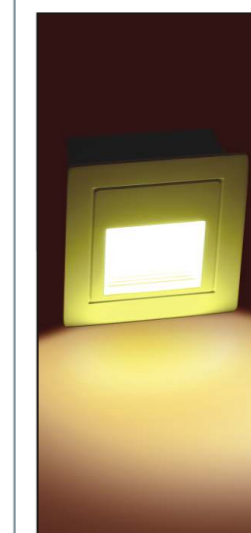

Product Code : LODPTW3
Product Features : Indoor
Voltage Range : AC 140 - 265V
Watts Available : 3W
Colors Available : WH, WW
Body Color : White
Body Finish : Aluminium Die Cast
IP Rating : IP40

TRITON



TRITON - Indoor & Outdoor Footlights & Pathway Lights

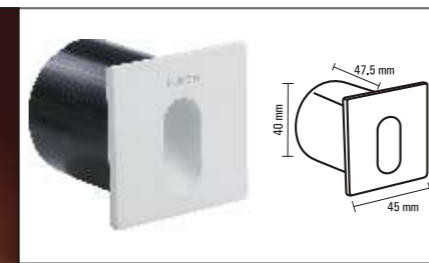

Product Code : LINS1
Product Features : Indoor Foot Light
Voltage Range : AC 140 - 265V
Watts Available : 1W
Colors Available : WH / WW
Body Color : White
Body Finish : Aluminium Die Cast
IP Rating : IP20

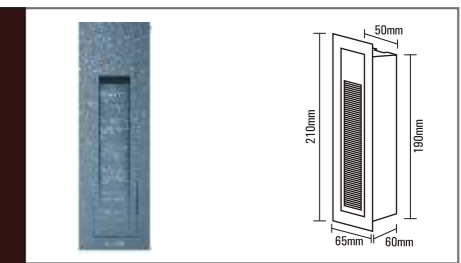

Product Code : LODFTV3
Product Features : Outdoor
Voltage Range : AC 140 - 265V
Watts Available : 3W
Colors Available : WH, WW
Body Color : Dark Grey
Body Finish : Aluminium Die Cast
IP Rating : IP65



Product Code : LOUR3
Product Features : Outdoor
Voltage Range : AC 140 - 265V
Watts Available : 3W
Colors Available : WW
Body Color : SS
Body Finish : Alu. Die Cast
IP Rating : IP65

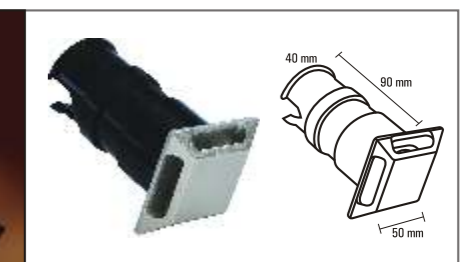

Product Code : LOUS04
Product Features : Outdoor
Voltage Range : AC 140 - 265V
Watts Available : 1W
Colors Available : WW
Body Color : SS
Body Finish : Aluminium Die Cast
IP Rating : IP65

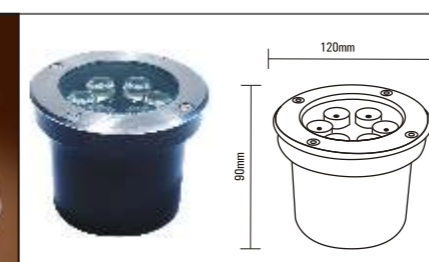

Product Code : LOUR6
Product Features : Outdoor
Voltage Range : AC 140 - 265V
Watts Available : 6W
Colors Available : WW
Body Color : Silver
Body Finish : Aluminium Die Cast
IP Rating : IP65

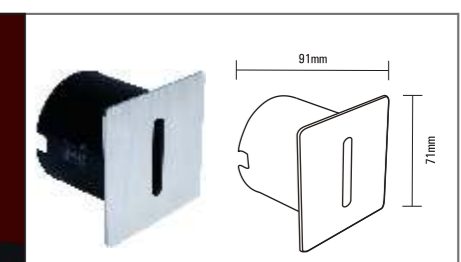

Product Code : LOUS5
Product Features : Outdoor
Voltage Range : AC 140 - 265V
Watts Available : 5W
Colors Available : WW
Body Color : Silver
Body Finish : Aluminium Die Cast
IP Rating : IP65

ZEUS



TRITON - Outdoor Footlights

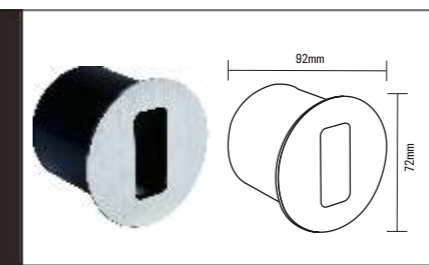

Product Code : LOUR5
Product Features : Outdoor
Voltage Range : AC 140 - 265V
Watts Available : 5W
Colors Available : WW
Body Color : Silver
Body Finish : Aluminium Die Cast
IP Rating : IP65

ZEUS - Gate Lights

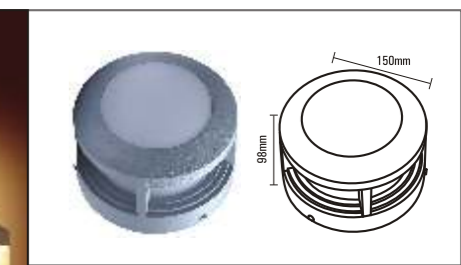

Product Code : LODGLR3
Product Features : Outdoor
Voltage Range : AC 140 - 265V
Watts Available : 8W
Colors Available : WH, WW
Body Color : Silver Grey
Body : Aluminium Die Cast
IP Rating : IP65

ZEUS - Gate Lights



Product Code : LGLRBGE-27
Product Features : Outdoor
Voltage Range : AC 140 - 265V
Watts Available : 18W
Colors Available : WH, WW
Body Color : Silver Grey
Body : Alu. Die cast with PMMA Diffuser
IP Rating : IP65

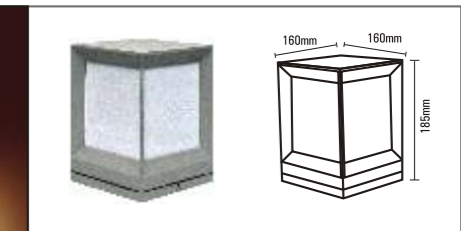

Product Code : LGLSMD
Product Features : Outdoor
Voltage Range : AC 140 - 265V
Watts Available : 10W
Colors Available : WH, WW
Body Color : Silver Grey
Body : Alu. Die Cast with PMMA Diffuser
IP Rating : IP65

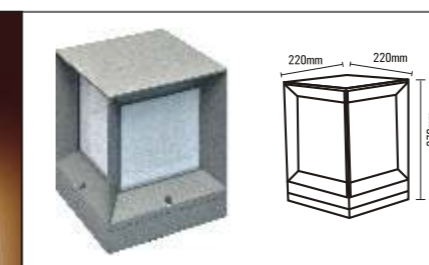

Product Code : LGLSBG
Product Features : Outdoor
Voltage Range : AC 140 - 265V
Watts Available : 18W
Colors Available : WH, WW
Body Color : Silver Grey
Body Finish : Alu. Die Cast with PMMA
IP Rating : IP65

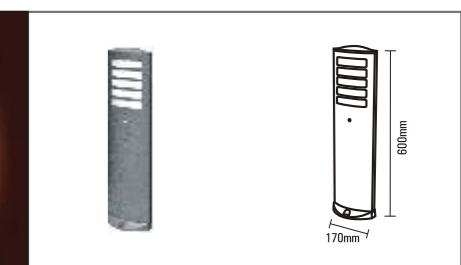

Product Code : LOBOV60
Product Features : Outdoor
Voltage Range : AC 140 - 265V
Watts Available : 12W
Colors Available : WW
Body Color : Silver Grey
Body : Alu. Die Cast Body with PMMA Diffuser
IP Rating : IP65

ZEUS



ZEUS - Outdoor Garden Lights & Gate Lights

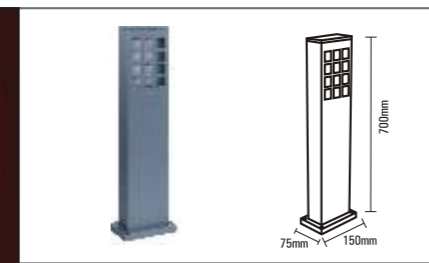

Product Code : LOBRT-70
Product Features : Outdoor
Voltage Range : AC 140 - 265V
Watts Available : 12W
Colors Available : WW
Body Color : Silver Grey
Body : Aluminium Die Cast
IP Rating : IP65

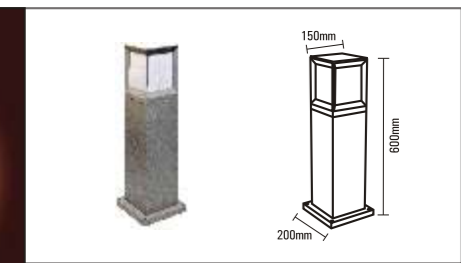

Product Code : LOBSQ60
Product Features : Outdoor
Voltage Range : AC 140 - 265V
Watts Available : 12W
Colors Available : WW
Body Color : Silver Grey
Body : Alu. Die Cast with PMMA Diffuser
IP Rating : IP65

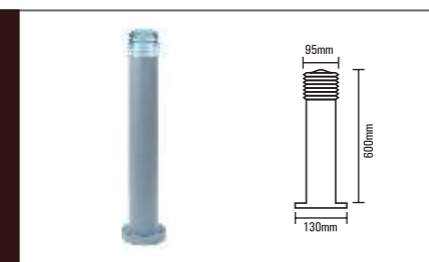

Product Code : LODBG05
Product Features : Outdoor
Voltage Range : AC 140 - 265V
Watts Available : 5W
Colors Available : WH, WW
Body Color : Black / Silver Grey
Body : Aluminium Die Cast
IP Rating : IP65

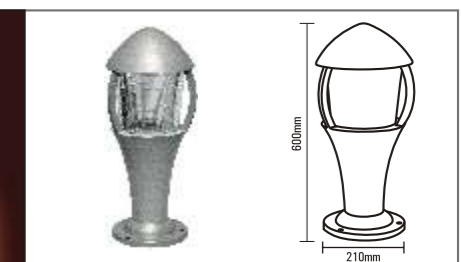

Product Code : LOBRD60
Product Features : Outdoor
Voltage Range : AC 140 - 265V
Watts Available : 18W
Colors Available : WH, WW
Body Color : Silver Grey
Body : Aluminium Die Cast
IP Rating : IP65

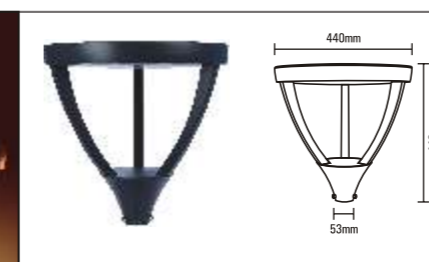

Product Code : LPL440
Product Features : Outdoor
Voltage Range : AC 140 - 265V
Watts Available : 60 W
Colors Available : WH, WW
Body Color : DARK GREY
Body : Aluminium Die Cast
IP Rating : IP65

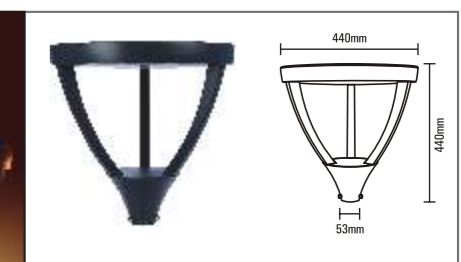

Product Code : LPL430
Product Features : Outdoor
Voltage Range : AC 140 - 265V
Watts Available : 30 W / 40 W
Colors Available : WH, WW
Body Color : Dark Grey
Body : Aluminium Die Cast
IP Rating : IP65

ZEUS



ZEUS - Outdoor Garden Lights & Gate Lights

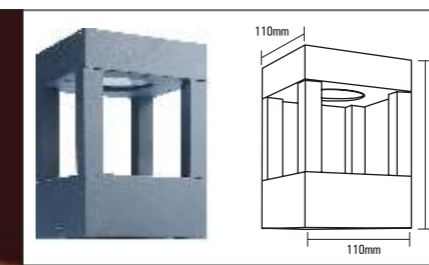

Product Code : LGLSQ06
Product Features : Outdoor
Voltage Range : AC 140 - 265V
Watts Available : 6 W
Colors Available : WH, WW
Body Color : Dark Grey
Body : Aluminium Die Cast
IP Rating : IP65

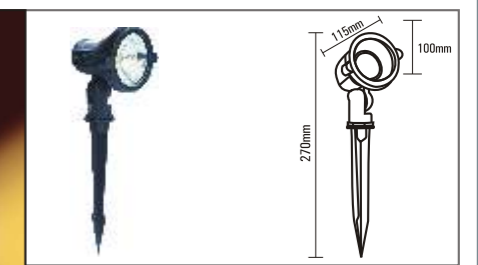

Product Code : LSSPK12W
Product Features : Outdoor
Voltage Range : AC 140 - 265V
Watts Available : 12W
Colors Available : WH, Green, Blue
Body Color : Black
Body Finish : Aluminium Die Cast
IP Rating : IP65

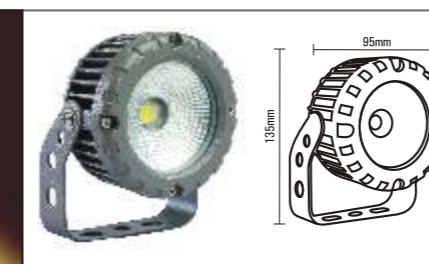

Product Code : LODSP05
Product Features : Outdoor
Voltage Range : AC 140 - 265V
Watts Available : 1 X 5 W
Colors Available : WH, WW
Body Color : Dark Grey
Body Finish : Aluminium Die Cast
IP Rating : IP65

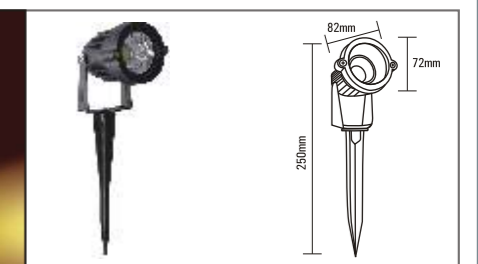

Product Code : LSSPK5W
Product Features : Outdoor
Voltage Range : AC 140 - 265V
Watts Available : 5W
Colors Available : WH, Green, Blue, RGB
Body Color : Black
Body Finish : Aluminium Die Cast
IP Rating : IP65

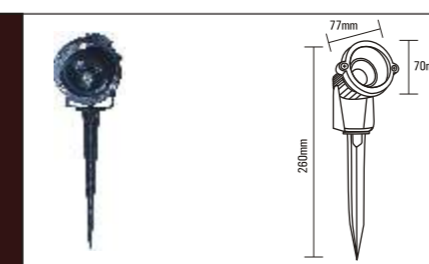

Product Code : LSSPK3W
Product Features : Outdoor
Voltage Range : AC 140 - 265V
Watts Available : 3W
Colors Available : WW
Body Color : Black
Body Finish : Aluminium Die Cast
IP Rating : IP65

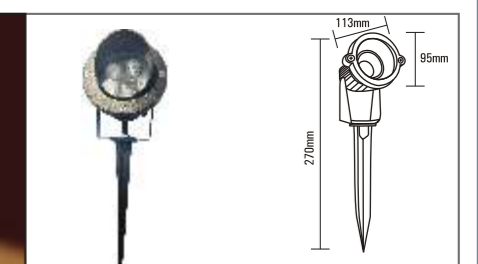
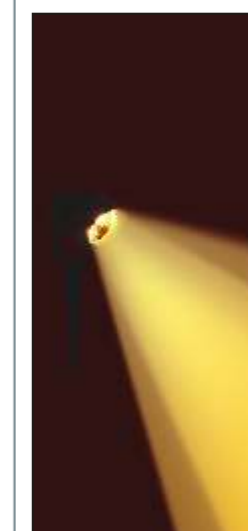

Product Code : LSSPK5W
Product Features : Outdoor
Voltage Range : AC 140 - 265V
Watts Available : 5W
Colors Available : WW
Body Color : Black
Body : Alu. Die Cast
IP Rating : IP65

ZEUS



ZEUS - Outdoor Garden Lights



Product Code : LODSP20
Product Features : Outdoor
Voltage Range : AC 140 - 265V
Watts Available : 20W
Colors Available : WW, WH, Green
Body Color : Dark Grey
Body : Aluminium Die Cast
IP Rating : IP65

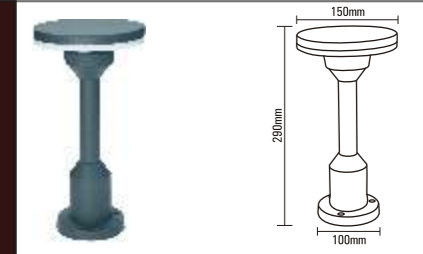

Product Code : LODBR10
Product Features : Outdoor
Voltage Range : AC 140 - 265V
Watts Available : 10 W
Colors Available : NW
Body Color : Dark Grey
Body : Aluminium Die Cast
IP Rating : IP65



Product Code : LODBR12
Product Features : Outdoor
Voltage Range : AC 140 - 265V
Watts Available : 12W
Colors Available : WH, WW
Body Color : Dark Grey
Body Finish : Aluminium Die Cast
IP Rating : IP65

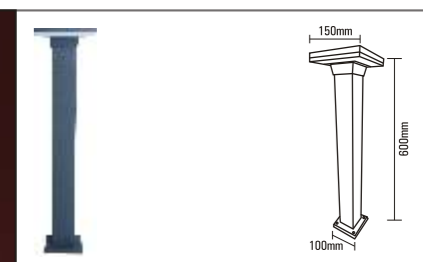

Product Code : LODBS12
Product Features : Outdoor
Voltage Range : AC 140 - 265V
Watts Available : 12W
Colors Available : WH, WW
Body Color : Dark Grey
Body Finish : Aluminium Die Cast
IP Rating : IP65

Outdoor Luminaires(IP65)



Product Code : LWL10E27
Product Features : Outdoor Wall Light
Body Color : Black
Body Finish : Aluminium Die Cast with PC diffuser
IP Rating : IP65
Holder Type : E27
Dimensions : L : 116mm
W : 105mm
H : 230mm



Product Code : LGL10E27
Product Features : Outdoor Gate Light
Body Color : Black
Body Finish : Aluminium Die Cast with PC diffuser
IP Rating : IP65
Holder Type : E27
Dimensions : L : 105 mm
W : 105 mm
H : 225 mm

*E27 LED Lamp sold separately for LWL10E27 & LGL10E27

APOLLO



APOLLO - Indoor Hanging Lights

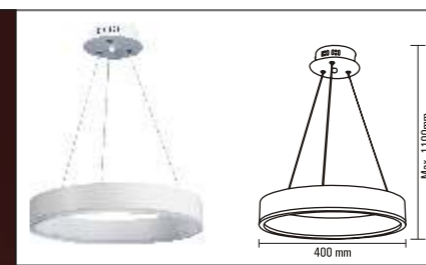

Product Code : LHL301
Product Features : Indoor
Voltage Range : AC 140 - 265V
Watts Available : 30W
Colors Available : WW
Body Color : White
Body : Alu. Die Cast
IP Rating : IP40

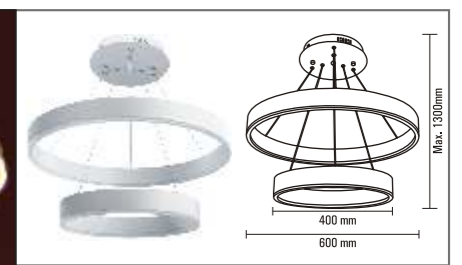

Product Code : LHL302
Product Features : Indoor
Voltage Range : AC 140 - 265V
Watts Available : 70W
Colors Available : WW
Body Color : White
Body : Aluminium Die Cast
IP Rating : IP40

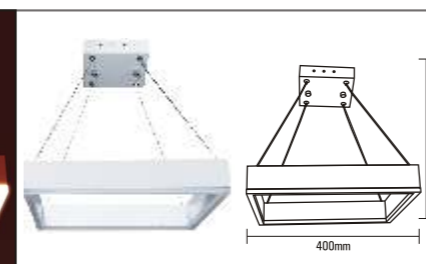
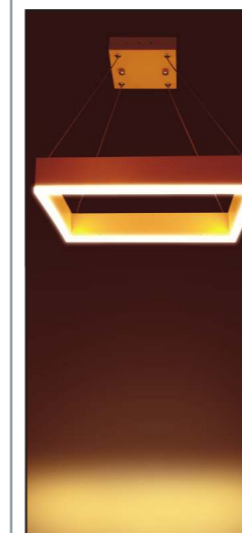

Product Code : LHL303
Product Features : Indoor
Voltage Range : AC 140 - 265V
Watts Available : 40W
Colors Available : WW
Body Color : White
Body : Alu. Die Cast Body with Acrylic Diffuser
IP Rating : IP40

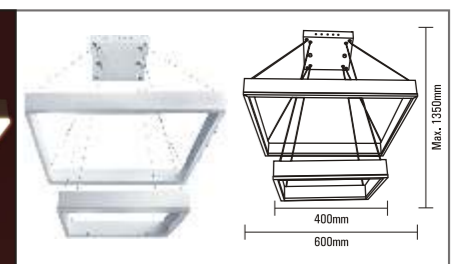
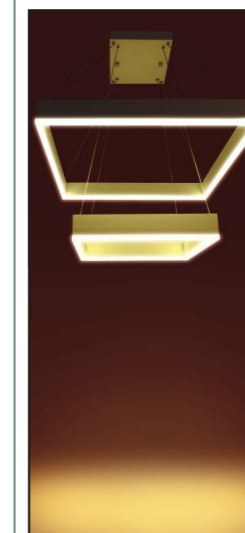

Product Code : LHL304
Product Features : Indoor
Voltage Range : AC 140 - 265V
Watts Available : 95W
Colors Available : WW
Body Color : White
Body : Aluminium Die Cast with Acrylic Diffuser
IP Rating : IP40

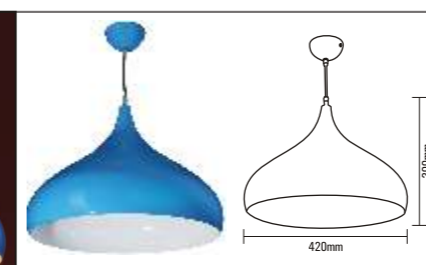

Product Code : LHL201
Product Features : Indoor
Voltage Range : AC 140 - 265V
Watts Available : 18W
Colors Available : WH, WW
Body Color : Blue
Body : Powder coated Aluminium
IP Rating : IP40

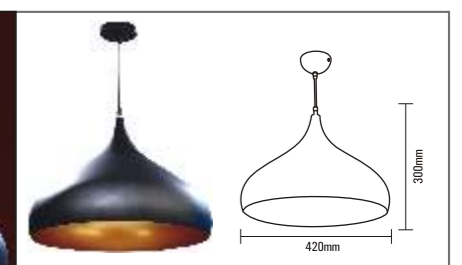

Product Code : LHL202
Product Features : Indoor
Voltage Range : AC 140 - 265V
Watts Available : 18W
Colors Available : WH, WW
Body Color : Matt Black
Body : Powder Coated Aluminium
IP Rating : IP40

*Hanging light series from LHL201 – LHL211 have a standard suspending wire length of 800mm.

APOLLO



APOLLO - Indoor Hanging Lights

	<p>Product Code : LHL203 Product Features : Indoor Voltage Range : AC 140 - 265V Watts Available : 12W Colors Available : WH, WW Body Color : Matt Black Body : Powder Coated Aluminium IP Rating : IP40</p>		<p>Product Code : LHL204 Product Features : Indoor Voltage Range : AC 140 - 265V Watts Available : 12 W Colors Available : WH, WW Body Color : White Body : Powder Coated Aluminium IP Rating : IP40</p>
	<p>Product Code : LSL205 Product Features : Indoor Voltage Range : AC 140 - 265V Watts Available : 12W Colors Available : WH, WW Body Color : Red Body Finish : Powder Coated Aluminium IP Rating : IP40</p>		<p>Product Code : LSL206 Product Features : Indoor Voltage Range : AC 140 - 265V Watts Available : 12W Colors Available : WH, WW Body Color : Matt Black & Gold Body Finish : Powder Coated Aluminium IP Rating : IP40</p>
	<p>Product Code : LSL207 Product Features : Indoor Voltage Range : AC 140 - 265V Watts Available : 12W Colors Available : WH, WW Body Color : White & Gold Body : Powder coated Aluminium IP Rating : IP40</p>		<p>Product Code : LSL208 Product Features : Indoor Voltage Range : AC 140 - 265V Watts Available : 6W Colors Available : WH, WW Body Color : Red Body : Powder Coated Aluminium IP Rating : IP40</p>

*Hanging light series from LHL201 – LHL211 have a standard suspending wire length of 800mm.

APOLLO

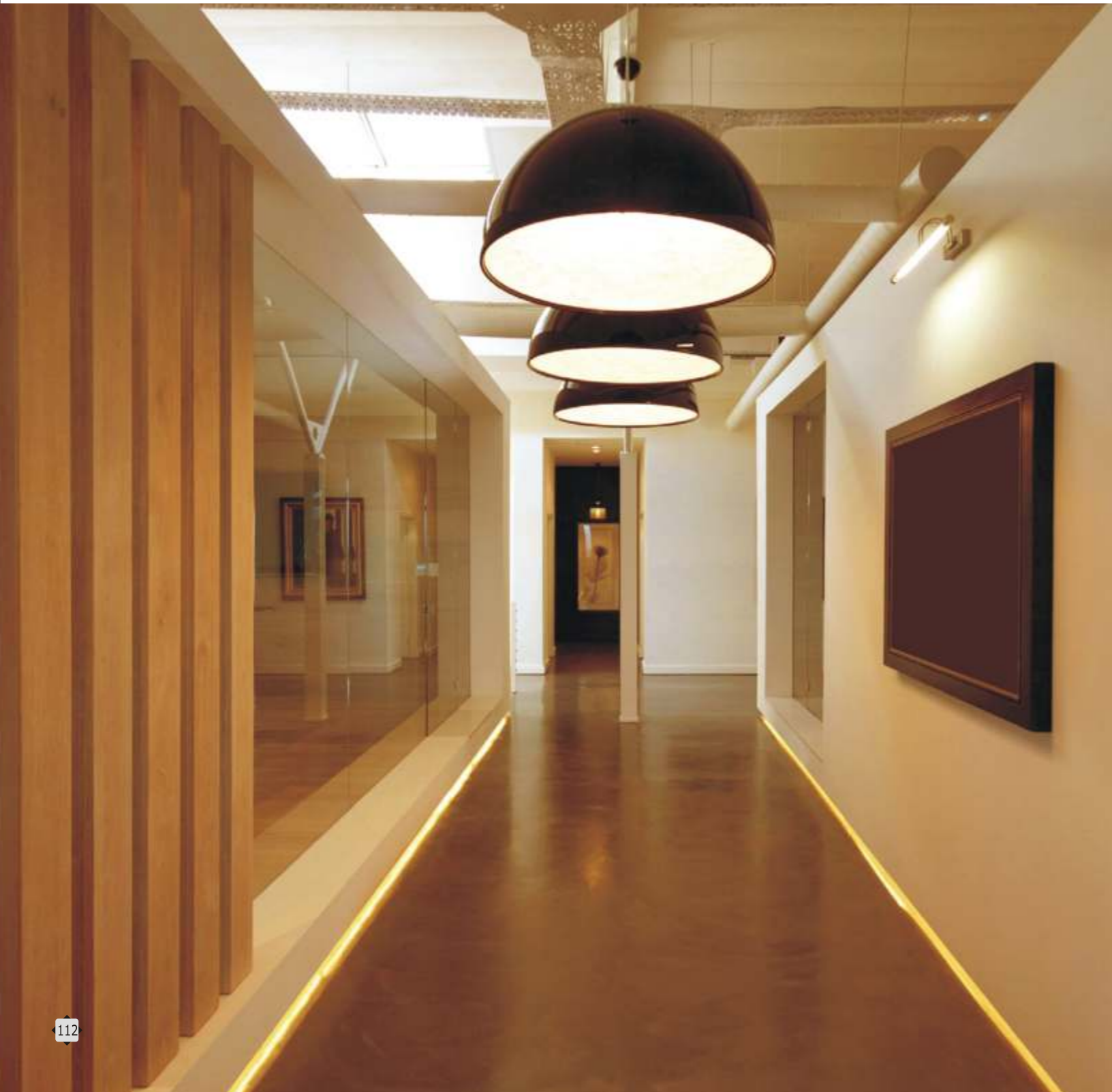

APOLLO - Indoor Hanging Lights

	 <p>Product Code : LSL209 Product Features : Indoor Voltage Range : AC 140 - 265V Watts Available : 6W Colors Available : WH, WW Body Color : Green Body : Powder Coated Aluminium IP Rating : IP40</p>		 <p>Product Code : LSL210 Product Features : Indoor Voltage Range : AC 140 - 265V Watts Available : 6W Colors Available : WH, WW Body Color : Pink Body : Powder Coated Aluminium IP Rating : IP40</p>
	 <p>Product Code : LSL211- 1 Product Features : Indoor Voltage Range : AC 140 - 265V Watts Available : 6W Colors Available : WH, WW Body Color : Black Body : Powder Coated Aluminium IP Rating : IP40</p>		 <p>Product Code : LSL211 - 3 Product Features : Indoor Voltage Range : AC 140 - 265V Watts Available : 18W Colors Available : WH, WW Body Color : Black Body : Powder Coated Aluminium IP Rating : IP40</p>
	 <p>Product Code : LHL305 Product Features : Indoor Voltage Range : AC 140 - 265V Watts Available : 20W Colors Available : WH, WW Body Color : White Body : ABS Plastic IP Rating : IP40</p>		 <p>Product Code : LHL305-3 Product Features : Indoor Voltage Range : AC 140 - 265V Watts Available : 60W Colors Available : WH, WW Body Color : White Body : ABS Plastic IP Rating : IP40</p>

*Hanging light series from LHL201 – LHL211 have a standard suspending wire length of 800mm.



LINEAR LIGHTING

LED LINEAR LIGHTING (ASSEMBLED)

Product Code : LPL70501M
Product Features : Indoor – Hanging / Surface
Voltage Range : AC 140 - 265V
Watts Available : 36W
Colors Available : WH, WW
Body Color : White
Body : Alu. Section with Acrylic Milky Diffuser
IP Rating : IP40
 (Standard packing is 1 mtr. fully assembled Linear profile with 1 set hanging string [LPLSHK] with 2mtr length.

Product Code : LPL70502M
Product Features : Indoor – Hanging / Surface
Voltage Range : AC 140 - 265V
Watts Available : 72W
Colors Available : WH, WW
Body Color : White
Body : Alu. Section with Acrylic Milky Diffuser
IP Rating : IP40
 (Standard packing is 2 mtr. fully assembled Linear profile with 1 set hanging string [LPLSHK] with 2mtr length.

Product Code : LPL44351M
Product Features : Indoor – Recessed
Voltage Range : AC 140 - 265V
Watts Available : 36W
Colors Available : WH, WW
Body Color : White
Body : Alu. Section with Acrylic Milky Diffuser
IP Rating : IP40
 (Standard packing is 1 mtr. fully assembled Linear profile with 1 set recessed mounting clips [LPLCLO2])

Product Code : LPL44352M
Product Features : Indoor – Recessed
Voltage Range : AC 140 - 265V
Watts Available : 72W
Colors Available : WH, WW
Body Color : White
Body : Alu. Section with Acrylic Milky Diffuser
IP Rating : IP40
 (Standard packing is 2 mtr. fully assembled Linear profile with 1 set recessed mounting clips [LPLCLO2])

LED LINEAR LIGHTING COMPONENTS*



Product Code : LPL2514
Product Features : Indoor – Recessed / Surface
Voltage Range : AC 140 - 265V
Body Color : Aluminium finish
Body : Alu. Section with Acrylic Milky Diffuser
Description : Standard packing is 3 mtr. Alu. profile with 4 nos. of mounting clips (LPLCLO1)

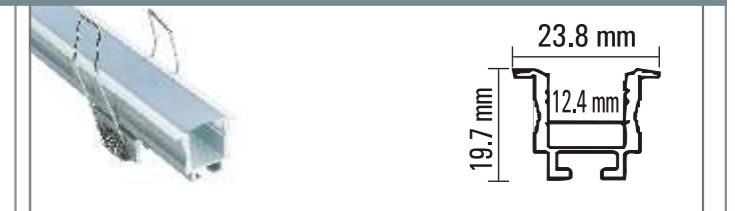

Product Code : LPL2319
Product Features : Indoor – Recessed
Voltage Range : AC 140 - 265V
Body Color : Aluminium finish
Body : Alu. Section with Acrylic Milky Diffuser
Description : Standard packing is 2 mtr. Alu. profile with 3 nos. of mounting clips (LPLCLO2).

For all Profile Channel 2 end cap will be provided. *LED Strip and drive to be purchased separately for LPL2514 & LPL2319.

LED LINEAR LIGHTING (COMPONENTS)*



Product Code : LPL0192
Product Features : Indoor – Corner Surface
Body Color : Aluminium finish
Body : Alu. Section with Acrylic Milky Diffuser
IP Rating : IP40
Description : Standard packing is 2 mtr. aluminium profile with 3 nos. of mounting clips (LPLCL01).

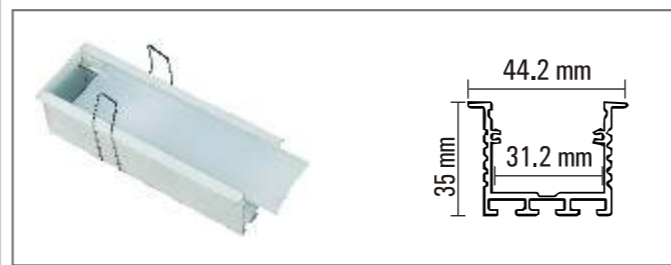

Product Code : LPL4435
Product Features : Indoor – Recessed
Body Color : White
Body : Alu. Section with Acrylic Milky Diffuser
IP Rating : IP40
Description : Standard packing is 2 mtr. aluminium profile with 3 nos. of recessed mounting clips (LPLCL02).



Product Code : LPLS180	LPLS120
Input Voltage : DC 12V	DC12V
Power Consumption : 18W per mtr.	12W per mtr.
Rated Luminous flux : 10 – 12 Lm / Chip	10 – 12 Lm / Chip
CRI : ≥80	≥80
Beam Angle : 120°	120°
LED Light Source : SMD 2835, 180 LEDs per mtr.	SMD2835, 120 LEDs per mtr.
Working Temp. : 0 – 40°C	0 – 40°C
Rated Life : 40000 hours	40000 hours
IP Rating : IP20	IP20
Std. Packing : 5 mtr.	5 mtr.



Product Code : LPLSD03
Input Volt. Range : AC 110 - 265V
Rated Power : 36W
Output Volt. Range : DC 12V
Efficiency : ≥85%
Working Temp. : 0° – 40°C
Amp Rating : 3 Amps



Product Code : LPLSD05
Input Volt. Range : AC 110 - 265V
Rated Power : 60W
Output Volt. Range : DC 12V
Efficiency : ≥85%
Working Temp. : 0° – 40°C
Amp Rating : 5 Amps



For all Profile Channel 2 end cap will be provided. *LED Strip and drive to be purchased separately for LPL0192, LPL2967 & LPL4435.

LED LINEAR LIGHTING (COMPONENTS)*

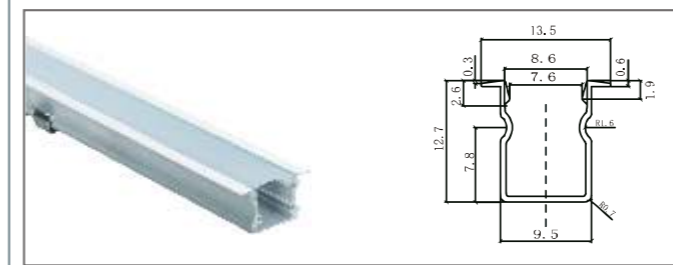

Product Code : LPL1413
Product Features : Surface
Body Color : Aluminium finish
Body : Alu. Section with Acrylic Milky Diffuser
IP Rating : IP40
Description : Standard packing is 3 mtr. aluminium profile with 4 nos. of mounting clips.

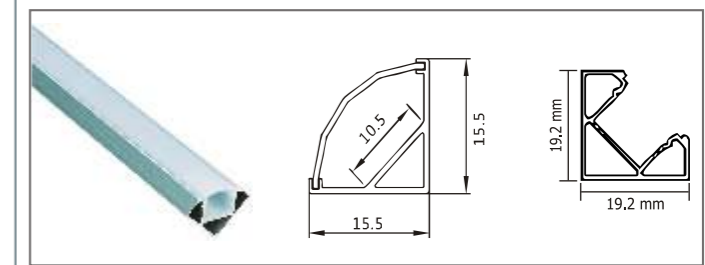

Product Code : LPL2115
Product Features : Indoor – Corner Surface
Body Color : Aluminium finish
Body : Alu. Section with Acrylic Milky Diffuser
IP Rating : IP40
Description : Standard packing is 3 mtr. aluminium profile with 4 nos. of mounting clips.



Product Code : LPL4026
Product Features : Indoor – Surface
Body Color : White
Body : Alu. Section with Acrylic Milky Diffuser
IP Rating : IP40
Description : Standard packing is 3 mtr. aluminium profile with 4 nos. of surface mounting clips.

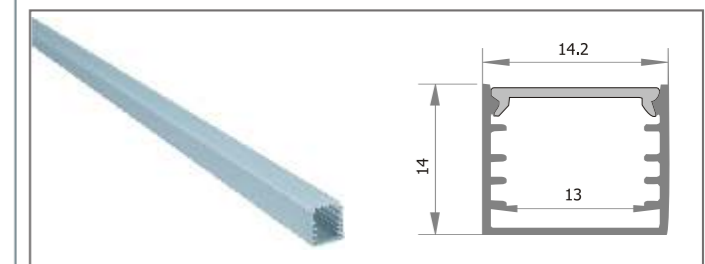

Product Code : LPL1414
Product Features : Indoor – Surface
Body Color : White
Body : Alu. Section with Acrylic Milky Diffuser
IP Rating : IP40
Description : Standard packing is 3 mtr. aluminium profile with 4 nos. of mounting clips.



Product Code : LPL5035
Product Features : Indoor – Recessed
Body Color : White
Body : Powder Coated Alu. Section with Acrylic Milky Diffuser
IP Rating : IP40
Description : Standard packing is 3 mtr. aluminium profile with 4 nos. of recessed mounting clips.

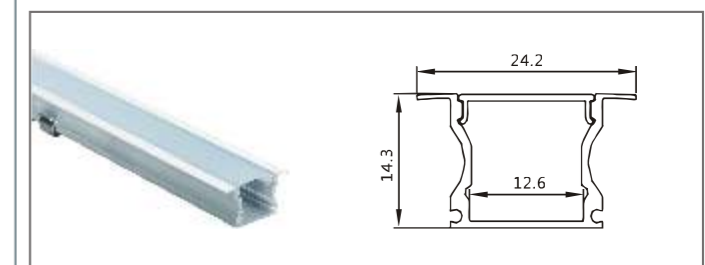

Product Code : LPL2514
Product Features : Indoor – Surface
Body Color : White
Body : Powder Coated Alu. Section with Acrylic Milky Diffuser
IP Rating : IP40
Description : Standard packing is 3 mtr. aluminium profile with 4 nos. of mounting clips.

For all Profile Channel 2 end cap will be provided.



SOLAR LED STREET LIGHTS



Product Code : LSTSOL10
Product Feature : Solar LED Street Light
 Radar Motion Sensor + Dusk to down operation
Active Power : 10W
Watts Available : 10W
Colors Available : WH
Solar Panel : 6V, 7W Monocrystalline
Body : ABS
Battery : 3.2V 5AH Li-ion
IP Rating : IP66
Charging Time : 6 - 8 Hrs.
Backup Time : 8 - 12 Hrs.
Dimensions : L: 360 mm | W: 185 mm | H: 57 mm



Product Code : LSTSOL18
Product Feature : Solar LED Street Light
 Radar Motion Sensor + Dusk to down operation
Active Power : 18W
Watts Available : 18W
Colors Available : WH
Solar Panel : 6V, 10W Monocrystalline
Body : ABS
Battery : 3.2V 10AH Li-ion
IP Rating : IP66
Charging Time : 6 - 8 Hrs.
Backup Time : 8 - 12 Hrs.
Dimensions : L: 465 mm | W: 190 mm | H: 57 mm



Product Code : LSTSOL24
Product Feature : Solar LED Street Light
 Radar Motion Sensor + Dusk to down operation
Active Power : 24W
Watts Available : 24W
Colors Available : WH
Solar Panel : 6V, 14W Monocrystalline
Body : ABS
Battery : 3.2V 12AH Li-ion
IP Rating : IP66
Charging Time : 6 - 8 Hrs.
Backup Time : 8 - 12 Hrs.
Dimensions : L: 595 mm | W: 195 mm | H: 57 mm



Product Code : LSTSOL30N
Product Feature : Solar LED Street Light
 Radar Motion Sensor + Dusk to down operation
Active Power : 30W
Watts Available : 30W
Colors Available : WH
Solar Panel : 10V, 20W Monocrystalline
Body : ABS
Battery : 3.2V 18AH Li-ion
IP Rating : IP66
Charging Time : 6 - 8 Hrs.
Backup Time : 8 - 12 Hrs.
Dimensions : L : 630 mm
 W : 250 mm
 H : 65mm



Product Code : LSTSOL30
Product Feature : Solar LED Street Light with Remote
Active Power : 12W
Watts Available : 30W
Colors Available : WH
Solar Panel : 6V, 7W Polycrystalline
Body : ABS
Battery : 12AH Li-Fe
IP Rating : IP65
Charging Time : 6 - 8 Hrs.
Backup Time : 12 - 14 Hrs. (with sensor off)
 : 20 - 24 Hrs. (sensor on)
Dimensions : L:325 mm | W: 225mm | H: 75mm

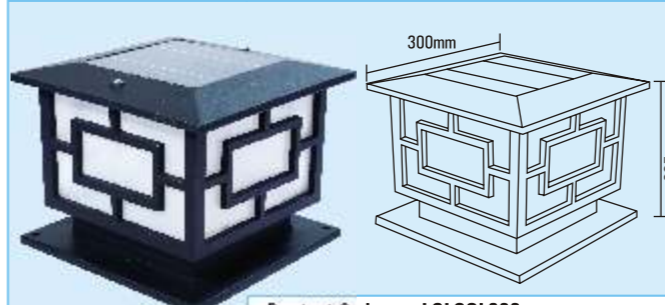

Product Code : LGLSOL300
Product Feature : Solar LED Gate Light
Watts Available : 4W
Colors Available : WH, WW
Solar Panel : 5V, 4.3W Polycrystalline
Body : Aluminium Die Cast
Battery : 4.8AH Li-Ion
IP Rating : IP65



Product Code : LBR SOL785
Product Feature : Solar LED Garden Light
Watts Available : 4W
Colors Available : WH, WW
Solar Panel : 5V, 3.5W Polycrystalline
Body : Aluminium Die Cast
Battery : 4AH Li-Ion
IP Rating : IP65

LSTSOL10, LSTSOL18, LSTSOL24, LSTSOL30N – Operation – Backup time 8–12 Hours, Full Brightness (1–2 hrs), 70% Brightness (3–4 hrs), 40% Brightness (5 – 6 hrs), 20% Brightness (After 6 hrs). Full brightness applicable only when sensor is active, if no activity in sensing range brightness will reduced to 30%.

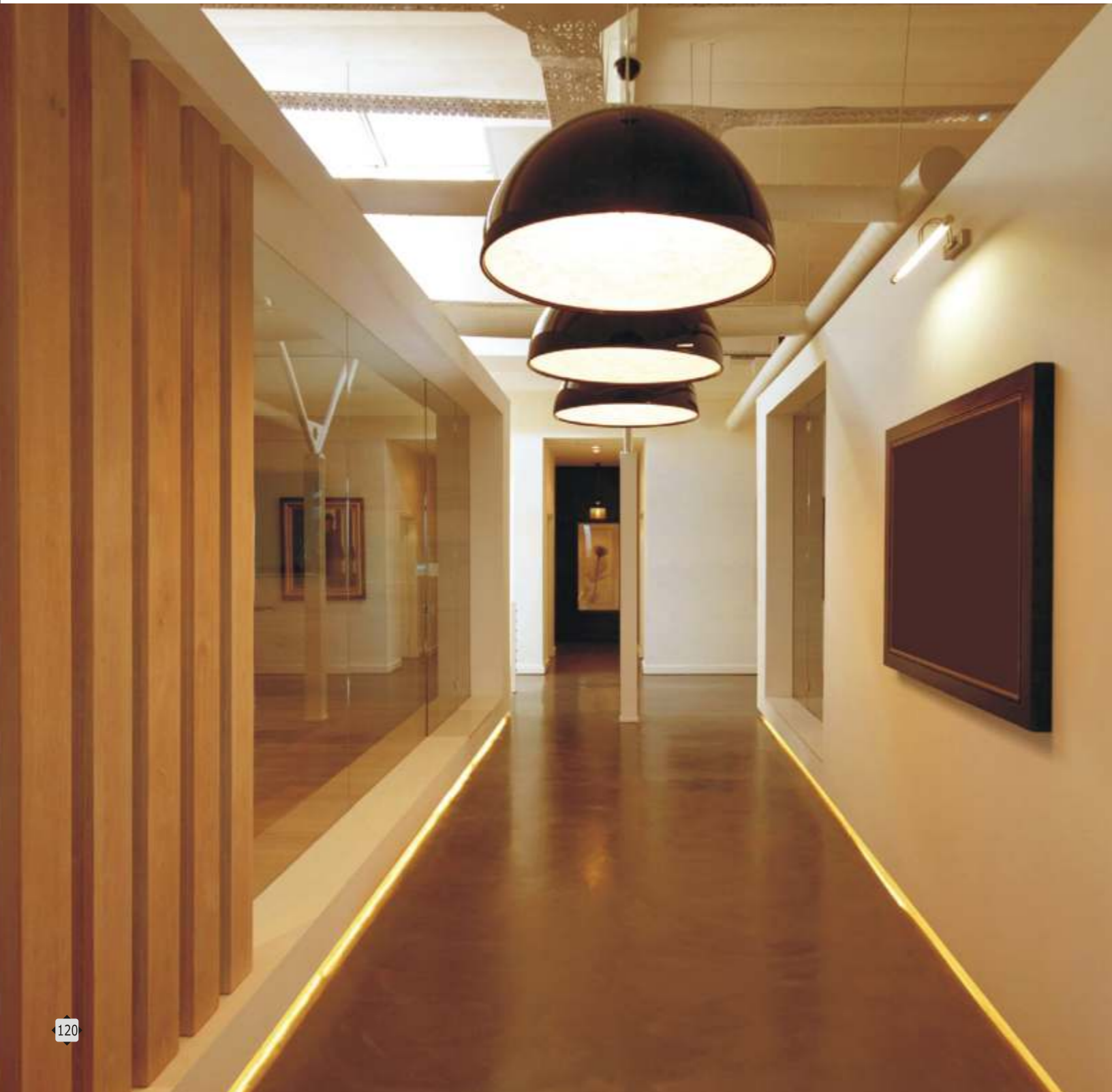

SOLAR LED ARCHITECTURAL LIGHTS



Item : Solar Garden Light
Product Code : LBSOL61
Watts : 5W
Colors Available : WH & WW (2 in 1)
Body Color : Matt Black
Body : Die Cast Aluminium
IP Rating : IP65
Specification : 3.7V 5200 mAh Battery
 5W / 5V Solar Panel
Operation : Automatic On/Off using LDR Sensor
 Light Color Changing with
 In-built Toggle Switch



Item : Solar Garden Light
Product Code : LBSOL500
Watts : 5W
Colors Available : WH, WW
Body Color : Matt Black
Body : Die Cast Aluminium
IP Rating : IP65
Specification : 3.7V 5200 mAh Battery
 5W / 5V Solar Panel
Operation : Automatic On/Off using
 Built-in LDR Sensor



Item : Solar Garden Light
Product Code : LBSOL600
Watts : 5W
Colors Available : WH, WW
Body Color : Matt Black
Body : Die Cast Aluminium
IP Rating : IP65
Specification : 3.7V 5200 mAh Battery
 4.5W / 5V Solar Panel
Operation : Automatic On/Off using
 Built-in LDR Sensor



Item : Solar Post Light
Product Code : LPTSOL2600
Watts : 10W
Colors Available : WH, WW
Body Color : Matt Black
Body : Die Cast Aluminium
IP Rating : IP65
Specification : 3.7V 5200 mAh x 2
 Battery
 5W / 5V Solar-
 Panel x 2
Operation : In-built LDR Sensor
 for Automatic On/Off
 based on
 ambient light
 conditions

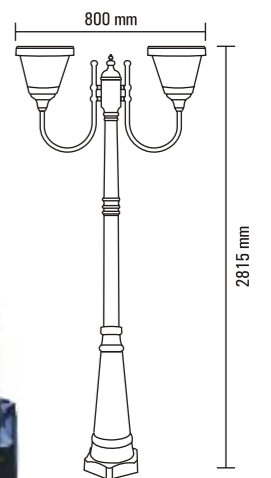

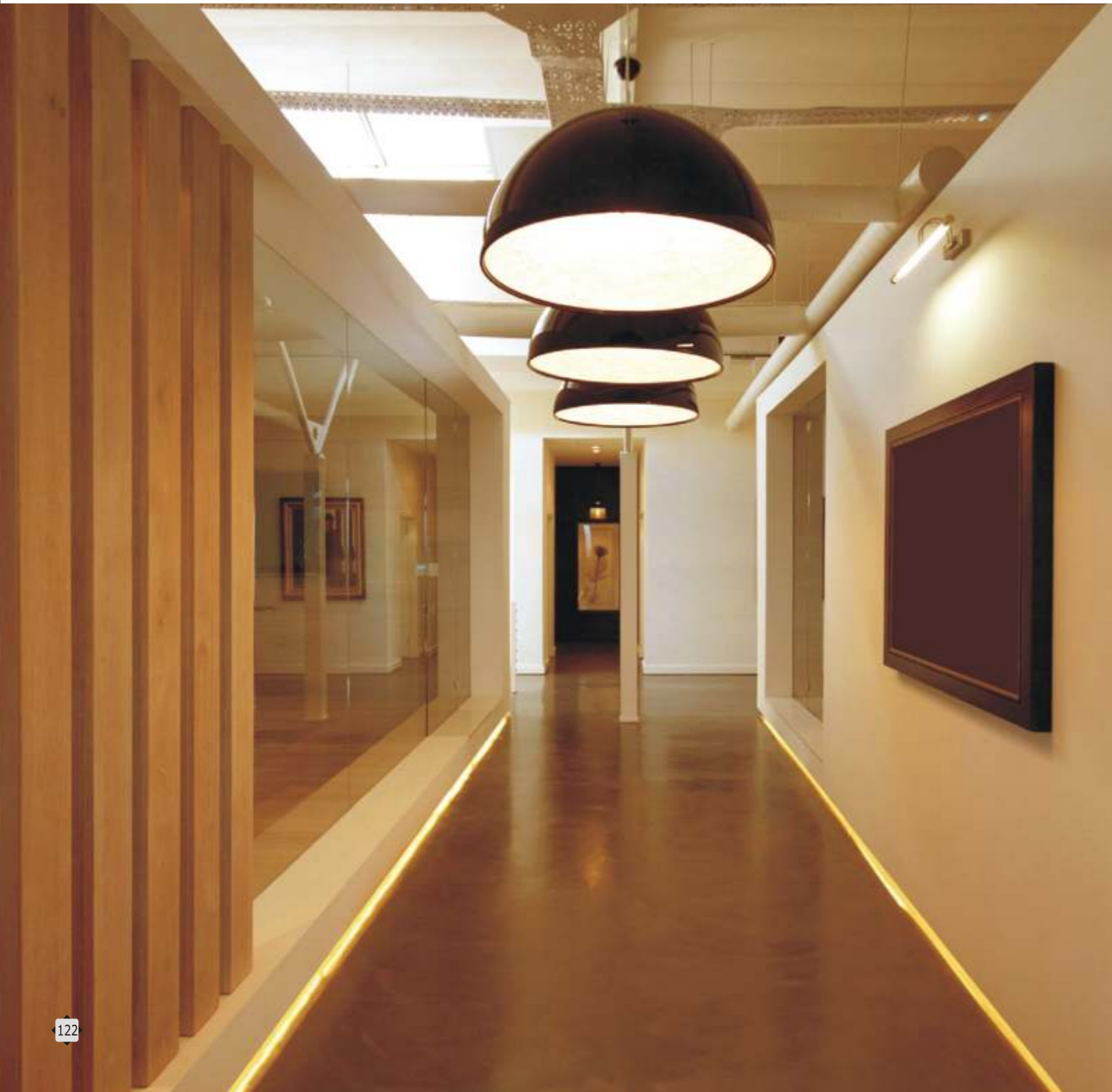

SOLAR LED ARCHITECTURAL LIGHTS



Item : Solar Wall Light
Product Code : LWLSOL03
Watts : 3W
Colors Available : WH, WW
Body Color : White
Body : PC
IP Rating : IP65
Specification : 3.7V 2200 mAh Battery
 2W Solar Panel
Operation : Automatic On/Off using LDR Sensor
 Master On/Off switch for optimised usage.



Item : Solar Gate Light
Product Code : LGLSOL31
Watts : 5W
Colors Available : WH & WW (2 in 1)
Body Color : Matt Black
Body : Die Cast Aluminium
IP Rating : IP65
Specification : 3.7V 5200 mAh Battery
 5W / 5V Solar Panel
Operation : Automatic On/Off using LDR Sensor
 Light Color Changing and Master off
 option with In-built Toggle Switch



Item : Solar Wall Light
Product Code : LWLSOL51
Watts : 5W
Colors Available : WH & WW (2 in 1)
Body Color : Matt Black
Body : Die Cast Aluminium
IP Rating : IP65
Specification : 3.7V 5200 mAh Battery
 5W / 5V Solar Panel
Operation : Automatic On/Off using LDR Sensor
 Light Color Changing and Master Off
 option with in-built Toggle Switch

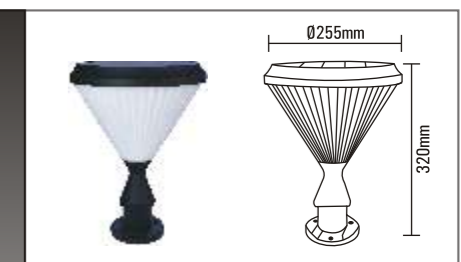

Item : Solar Gate Light
Product Code : LGLSOL57
Watts : 5W
Colors Available : WH, WW
Body Color : Matt Black
Body : Die Cast Aluminium
IP Rating : IP65
Specification : 3.7V 5200 mAh Battery
 5W / 6V Solar Panel
Operation : Automatic On/Off using LDR Sensor
 Master On/Off switch for optimised
 usage

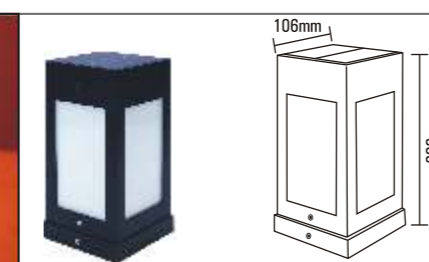

Item : Solar Gate Light
Product Code : LGLSOL10
Watts : 2W
Colors Available : WH, WW
Body Color : Black
Body : PC
IP Rating : IP65
Specification : 3.7V 2200 mAh Battery
 3W / 5V Solar Panel
Operation : Automatic On/Off using LDR Sensor
 Master On/Off switch for optimised
 usage



Item : Solar Gate Light
Product Code : LGLSOL45
Watts : 5W
Colors Available : WH, WW
Body Color : Matt Black
Body : Die Cast Aluminium
IP Rating : IP65
Specification : 3.7V 5200 mAh Battery
 5W / 5V Solar Panel
Operation : Automatic On/Off using LDR Sensor
 Master On/Off switch for optimised
 usage

Blank lined area for notes or additional information.

WARRANTY TERMS AND CONDITIONS

The company, Luker Electric Technologies Pvt Ltd offers warranty period to the buyers of its products under conditions set out hereafter. The warranty period applies to the functional defects of the Luker range of products resulting from the defectiveness of the material being used or irregularities in the production process, provided that the product is mounted and used in accordance with the Manufacturer's instructions and requirements mentioned in the catalogue or instruction manuals provided. Kindly note that different products are provided with different warranty period and it is mentioned in the product catalogues or may be confirmed with the company before purchase.

Products, for which the warranty provided is that the manufacturer will repair or replace at its discretion with the products of the same type and, at least, the same quality at its own expense. The company will not cover any losses caused to property or person directly or indirectly with the usage of the Luker range of products. The maximum liability due to malfunction of the product is limited only up to its purchase cost of the product.

The warrantee is invalid and not applicable incase of the conditions further detailed below.

If the product is not used in accordance with the Manufacturer's instructions or the product is used for purposes other than those for which it was designed or the incorrect assembly of the product. If Mechanical damage and faults caused by the Buyer's or third party's incorrect handling of the product or Damage and faults caused by natural disasters (lightning, faults caused by natural disasters (lightning, earthquake, fire, floods etc. or Damage and faults caused by the incorrect electrical voltage (for example, electrical stroke, high voltage surge and similar). If any repairs and interventions in products by unauthorized persons or any modifications of the product done by the customer.

Any disputes arising under this warranty clause shall fall only within the jurisdiction of the courts at Ernakulam, Kerala, India.